

# Anchoring, Fastening, Restoration and Strengthening Systems for Concrete and Masonry

C-A-2021 | (800) 999-5099 | [strongtie.com](http://strongtie.com)

**SIMPSON**

**Strong-Tie**



**SIMPSON**

**Strong-Tie**

**CI-LV**

**Epoxy**

# Taking testing and service to new heights.



For nearly sixty-five years, Simpson Strong-Tie has believed the only true strength is tested strength. That's why our products are rigorously tested and load rated. But we also know every construction project is unique. So we frequently take the added step of offering full-scale application testing. Which means that whatever your design and building specs, we can create real-world conditions in our university-grade labs to make sure our products will work in your project.

It's just another example of how we exceed other manufacturers' practices to ensure your success. From design services to technical support to cutting-edge software — like Anchor Designer™ — we're uncompromising in our quest to help you design the best solution for your building challenges.























# Product Selection Guide

Product			Page No.	Tested Base Materials and Code Listings					Other Listings	
				Concrete		Concrete on Metal Deck	CMU			Unreinforced Clay Brick Masonry
				Cracked	Uncracked		Grout-Filled	Hollow		
Adhesive Anchors	SET-3G™		22	ESR-4057 (COLA), FL15730	—	—	—	—	ASTM C881/ AASHTO M235, DOT, CDPH Std. Method v1.2, NSF/ANSI/CAN Std 61	
	SET-XP®		30	ESR-2508 (COLA), FL15730	—	ER-265 (COLA), FL16230		—	ASTM C881/ AASHTO M235, DOT, CDPH Std. Method v1.2, NSF/ANSI/CAN Std 61	
	ET-HP®		44	ESR-3372 (COLA), FL15730	—	ER-241 (COLA), FL16230	—	ESR-3638 (COLA)	ASTM C881/ AASHTO M235, DOT	
	AT-XP®		54	ER-263 (COLA), FL16230	—	ER-281 (COLA), RR25966, FL16230		—	ASTM C881/ AASHTO M235, DOT, CDPH Std. Method v1.2, NSF/ANSI/CAN Std 61	
Restoration Solutions	 CI-SLV		208	—	—	—	—	—	ASTM C881/ AASHTO M235	
	 CI-LV		210	—	—	—	—	—	ASTM C881/ AASHTO M235 NSF/ANSI/CAN Std 61	
	 CI-LV FS		212	—	—	—	—	—	ASTM C881/ AASHTO M235	
	 CI-LPL		214	—	—	—	—	—	ASTM C881/ AASHTO M235	
	 CI-GV		216	—	—	—	—	—	ASTM C881/ AASHTO M235	
	Heli-Tie™		230	—	Non-IBC	—	Non-IBC	Non-IBC	Non-IBC	Wood Metal Stud







Refer to footnotes on p. 6.

# Product Selection Guide

Product			Page No.	Tested Base Materials and Code Listings						Other Listings	
				Concrete		Concrete on Metal Deck	CMU		Unreinforced Clay Brick Masonry		Other
				Cracked	Uncracked		Grout-Filled	Hollow			
Mechanical Anchors	Titen HD® (THD)		78	ESR-2713 (COLA), FL15730			ESR-1056 (COLA), FL15730		—	—	FM, DOT
	Stainless-Steel Titen HD® (THD-SS)		92	ER-493 (COLA), FL16230			ESR-1056 (COLA), FL15730		—	—	DOT
	 Titen HD® Countersunk (THD-CS)		79	ESR-2713 (COLA), FL15730			ESR-1056 (COLA), FL15730		—	—	DOT
	 Stainless-Steel Titen HD® Countersunk (THD-CS-SS)		93	ER-493 (COLA), FL16230			ESR-1056 (COLA), FL15730		—	—	DOT
	 Titen HD® Washer Head (THD-WH)		79	ESR-2713 (COLA) FL 15730			IBC		—	—	DOT
	Titen HD® Rod Coupler (THD-RC)		104	ESR-2713 (COLA), FL15730			—	IBC	—	—	DOT
	Titen HD® Rod Hanger (THD-RH)		152	ESR-2713 (COLA), FL15730			—	—	—	—	FM
	Strong-Bolt® 2 (STB2)		108	ESR-3037 (COLA), FL15730			ER-240 (COLA), FL16230	—	—	—	UL, FM, DOT
	Wedge-All® (WA)		123	—	Non-IBC	Non-IBC	ESR-1396, FL15730	—	—	—	UL, FM, DOT
	Sleeve-All® (SL)		136	—	Non-IBC	—	Non-IBC	—	—	—	UL, FM, DOT
	Easy-Set (EZAC)		141	—	Non-IBC	—	—	—	—	—	—
	Tie-Wire (TW)		142	—	Non-IBC	Non-IBC	—	—	—	—	—
	 Titen Turbo™ (TNT)		144	—	ER-712 (COLA), FL16230	—	ER-716 (COLA), FL16230		—	—	—
	Steel Rod Hanger (RSH, RSV)		156	—	—	—	—	—	—	IBC (Steel)	UL, FM

Refer to footnotes on p. 6.

# Product Selection Guide

Product			Page No.	Tested Base Materials and Code Listings							Other Listings
				Concrete		Concrete on Metal Deck	CMU		Unreinforced Clay Brick Masonry	Other	
				Cracked	Uncracked		Grout-Filled	Hollow			
Mechanical Anchors	Wood Rod Hanger (RWH, RWW)		158	—	—	—	—	—	—	IBC (Wood)	UL, FM
	Drop-In (DIAB)		160	—	Non-IBC	Non-IBC	—	—	—	—	UL, FM
	Drop-In Anchor (Stainless Steel: DIA-SS) (Short: DIA-S)		165	—	Non-IBC	Non-IBC	—	—	—	Non-IBC (Hollow-Core Concrete Panel)	UL, FM, DOT
	Hollow Drop-In (HDIA)		170	—	Non-IBC	—	—	IBC	—	Non-IBC (Hollow-Core Concrete Panel)	UL, FM
	Zinc Nailon™ (ZN)		174	—	Non-IBC	—	—	—	—	—	—
	Crimp Drive® (CD)		175	—	Non-IBC	Non-IBC	—	—	—	—	FM
	Split Drive (CSD, DSD)		179	—	Non-IBC	—	—	—	—	—	—
	Sure Wall (SWN, SWZ)		181	—	—	—	—	—	—	—	Drywall
Direct Fastening	Powder-Actuated Fasteners		184	—	ESR-2138 (COLA), FL15730				—	Steel, ESR-2138 (COLA), FL15730	—
	Gas-Actuated Fasteners		188	—	ESR-2811 (COLA), FL15730				—	Steel, ESR-2811 (COLA), FL15730	—
Drill Bits	DXS Bits		236	ESR-4057 (SET-3G™) ESR-2508 (SET-XP®) ER-263 (AT-XP®)		—	—	—	—	—	—

ESR — ICC-ES code report available at [icc-es.org](http://icc-es.org).  
 ER — IAPMO UES code report available at [iapmoes.org](http://iapmoes.org).  
 COLA — City of Los Angeles Supplement within the ICC-ES or IAPMO UES code report. See supplement for LA Building Code compliance.  
 FL — Florida building code approval available.  
 IBC — Load data is available in this catalog intended for use under IBC, but code listings are not available.

Non-IBC — Load data is available in this catalog, but it is outside the scope of the current IBC. May be permitted for non-IBC applications.  
 UL — Underwriters Laboratories listing available.  
 FM — Factory Mutual listing available.  
 DOT — Various departments of transportation listings available. See [strongtie.com/DOT](http://strongtie.com/DOT) for details.

Consult the code listings for more detailed information on which models of each product are covered by the listing.

# Simpson Strong-Tie Company Inc.

For more than 60 years, Simpson Strong-Tie has focused on creating structural products that help people build safer and stronger homes and buildings. A leader in structural systems research and technology, Simpson Strong-Tie is one of the largest suppliers of structural building products in the world. The Simpson Strong-Tie commitment to product development, engineering, testing and training is evident in the consistent quality and delivery of its products and services.

For more information, visit the company's website at [strongtie.com](http://strongtie.com).

The Simpson Strong-Tie Company Inc. No Equal Pledge® includes:

- Quality products value-engineered for the lowest installed cost at the highest-rated performance levels
- The most thoroughly tested and evaluated products in the industry
- Strategically located manufacturing and warehouse facilities
- National code agency listings
- The largest number of patented connectors in the industry
- Global locations with an international sales team
- In-house R&D and tool and die professionals
- In-house product testing and quality control engineers
- Support of industry groups including AISI, AITC, ASTM, ASCE, AWC, AWPA, ACI, AISC, CSI, CFSEI, ICFA, NBMDA, NLBMDA, SDI, SETMA, SFA, SFIA, STAFDA, SREA, NFBA, TPI, WDSC, WIJMA, WTCA and local engineering groups

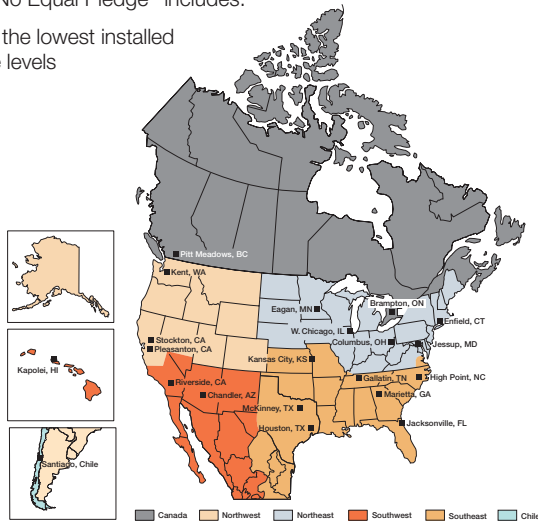

## Product Identification Key

Products and additional information are divided into eight general categories, identified by tabs along the page's outer edge.

**Adhesive Anchors**

20-75 ▶

**Mechanical Anchors**

76-181 ▶

**Direct Fastening Solutions**

182-197 ▶

**Restoration Solutions**

198-233 ▶

**Carbide Drill Bits**

234-239 ▶

**Appendix**

240-269 ▶

**Glossary of Terms**

270-272 ▶

**Alphabetical Index of Products**

273-274 ▶

## The Simpson Strong-Tie Quality Policy

We help people build safer structures economically. We do this by designing, engineering and manufacturing No-Equal® structural connectors and other related products that meet or exceed our customers' needs and expectations. Everyone is responsible for product quality and is committed to ensuring the effectiveness of the Quality Management System.

Karen Colonias  
Chief Executive Officer

## Getting Fast Technical Support

When you call for engineering technical support, we can help you quickly if you have the following information at hand. This will help us to serve you promptly and efficiently.

- Which Simpson Strong-Tie® catalog are you using? (*See the front cover for the form number.*)
- Which Simpson Strong-Tie product are you using?
- What are the design requirements (i.e., loads, anchor diameter, base material, edge/spacing distance, etc.)?

## We Are ISO 9001:2015 Registered

Simpson Strong-Tie is an ISO 9001:2015 registered company. ISO 9001:2015 is an internationally recognized quality assurance system that lets our domestic and international customers know they can count on the consistent quality of Simpson Strong-Tie® products and services.







**800-999-5099 | [strongtie.com](http://strongtie.com)**

# Table of Contents

## Adhesive Anchors

Adhesive Accessories.....	68–75
Adhesive Anchoring Installation Instructions.....	64–67
Adhesive Retaining Caps.....	70
All Thread Rod.....	75
AT-XP® Acrylic Adhesive .....	54–63
ET-HP® Epoxy Adhesive .....	44–53
Hole-Cleaning Brushes.....	68
 Opti-Mesh Adhesive-Anchoring Screen Tubes.....	71–72
Piston Plug Delivery System .....	69–70
Retrofit Bolts.....	74
SET-3G® Epoxy Adhesive .....	22–28
SET-XP® Epoxy Adhesive.....	30–43
Steel Adhesive-Anchoring Screen Tubes.....	73
Wire Brushes / Extensions / T-Handles .....	68

## Mechanical Anchors





Crimp Drive® Anchor.....	175–178
Drop-In Internally Threaded Anchor (DIAB).....	160–164
Drop-In Stainless-Steel Internally Threaded Anchor (DIA) .....	165–169
Easy-Set Pin-Drive Anchor.....	141
Hollow Drop-In Anchor .....	170–173
Sleeve-All® Sleeve Anchor .....	136–140
Split-Drive Anchor.....	179–180
Steel Rod Hanger .....	156–157
Strong-Bolt® 2 Wedge Anchor.....	108–122
Sure Wall Drywall Anchor.....	181
Tie-Wire Anchor.....	142–143
 Titen HD® Countersunk Screw Anchor.....	79
Titen HD® Rod Coupler.....	104–106
Titen HD® Screw Anchor .....	78–91
 Titen HD® Stainless-Steel Countersunk Screw Anchor.....	93–103
Titen HD® Stainless-Steel Screw Anchor.....	92–103
Titen HD® Threaded Rod Hanger.....	152–155
 Titen HD® Washer-Head Screw Anchor .....	79
Titen® Stainless-Steel Screw.....	150–151
 Titen Turbo™ Screw Anchor .....	144–149
Wedge-All® Wedge Anchor.....	123–135
Wood Rod Hanger .....	158–159
Zinc Nailon™ Pin Drive Anchor .....	174

New products are shown with the  symbol.

## Direct Fastening Solutions

Gas- and Powder-Actuated Fasteners Load Tables .....	189–197
Gas Tool / Fastener Suitability .....	188
Powder-Actuated Tool / Fastener Suitability .....	184
Powder-Actuated Tools, Fasteners and Loads.....	185–187

## Restoration Solutions

 CI-SLV Super Low Viscosity Injection Epoxy .....	208–209
 CI-LV Low Viscosity Injection Epoxy.....	210–211
 CI-LV FS Low Viscosity Fast Setting Injection Epoxy.....	212–213
 CI-LPL Low Viscosity Long Pot Life Injection Epoxy.....	214–215
 CI-GV Gel Viscosity Injection Epoxy .....	216–217
CIP-F Flexible Paste-Over Adhesive and Crack Sealant .....	222
CIP-LO Low Odor Paste-Over Epoxy and Crack Sealant .....	222
Crack Injection Guide .....	224–229
Crack-Pac® Flex-H <sub>2</sub> O™ .....	220–221
Crack-Pac® Injection Epoxy .....	218–219
Crack Repair Accessories.....	223
CSS Composite Strengthening Systems™ .....	200–204
ETR Concrete Repair and Paste-Over Epoxy.....	222
FX-70® Structural Pile Repair and Protection System .....	206–207
Heli-Tie™ Helical Stitching Tie.....	233
Heli-Tie™ Helical Wall Tie.....	230–232

## Carbide Drill Bits and Accessories

Core Bits .....	238
Demolition Bits .....	239
SDS-max® Drill Bits .....	237
SDS-plus® Drill Bits.....	236–237
Speed Clean™ DXS Dust Extraction Drill Bits.....	236
Spline Shank Drill Bits.....	238
Straight Shank Drill Bits .....	238

## Additional Information

Alphabetical Index of Products .....	273–274
Corrosion Information .....	261–262
General Instructions for the Designer .....	16
General Instructions for the Installer .....	14
Glossary of Common Terms .....	270–272
Market Segments and Applications .....	241–253
Product Selection Guide.....	4–6
Supplemental Topics for Anchors .....	254–269
Table Icon System .....	12



# New Products



6-lobe drive

Flat Head Screw

Hex-Head Screw

## Titen Turbo™ Concrete and Masonry Screw Anchor

Reliable installation. Less torque. Superior holding power. The Titen Turbo is the next-generation concrete and masonry screw anchor. The revolutionary Torque Reduction Channel traps dust where it can't obstruct the thread action, drastically reducing binding, stripping or snapping.

See pp. 144–149 for more information.



6-lobe drive

Carbon Steel

Stainless Steel

## Titen HD® Heavy-Duty Screw Anchor Countersunk Head Style

For use in cracked and uncracked concrete, as well as masonry. The Titen HD (carbon steel) is designed for use in dry, interior, noncorrosive environments or temporary outdoor applications, while the Titen HD Type 316 stainless-steel option offers you long-lasting corrosion resistance for unsurpassed peace of mind. The countersunk head style is for applications that require a flush-mount profile.

See p. 79 for more information.



6-lobe drive

## Titen HD® Heavy-Duty Screw Anchor with Washer Head

A high-strength screw anchor for use in cracked and uncracked concrete, as well as masonry. The washer-head design is commonly used where a minimal head profile is necessary. The anchor's 6-lobe drive eases driving and is less prone to stripping.

See p. 79 for more information.

## New Products



### Crack Repair CI Structural Injection Epoxy

CI structural injection epoxies are two-component, high solids formulations for injection into cracks in concrete. These epoxies provide a waterproof, high-strength structural repair. Available in five formulations (CI-SLV, CI-LV, CI-LVFS, CI-LPL and CI-GV) for cracks ranging from 0.002" to ¼" (0.05 mm to 6.4 mm).

See pp. 208–217 for more information.



### Opti-Mesh Screen Tubes for SET-3G™ and AT-XP®

Screen tubes are vital to the performance of adhesive anchors in base materials that are hollow or contain voids, such as hollow block and brick. Our Opti-mesh screen tubes are now available to support our SET-3G and AT-XP products.

See pp. 71–72 for more information.

# How to Use This Catalog

## Using Data Tables and Load Tables

This catalog contains both strength design data tables and allowable load tables. Some allowable load tables for concrete were established under old qualification standards that are no longer valid under the IBC. The following icons indicate whether or not a given table is intended to be used under the IBC (or under other building codes that use the IBC as their basis):



Valid for International Building Code



Not Valid for International Building Code

Tables that are “not valid for International Building Code” may be used where the designer determines that other building codes or regulations permit it — for example, under AASTHO or temporary construction.

### Strength Design Data Tables

Under the IBC, strength design (see p. 272) must be used for cast-in-place and post-installed mechanical and adhesive anchors that are installed into concrete. The design data from these tables are to be used with the design provisions of ACI 318-14 Chapter 17, ACI 318-11 Appendix D, IBC Chapter 19 and the respective ICC-ES Acceptance Criteria. Given the complexity of strength design calculations, designers may find Simpson Strong-Tie® Anchor Designer™ software ([strongtie.com/software](http://strongtie.com/software)) to be a great time saver for computing anchor design strengths.

SET-3G Tension Strength Design Data for Threaded Rod in Normal-Weight Concrete <sup>1, 8</sup>										
Characteristic	Symbol	Units	Nominal Rod Diameter (in.)							
			3/8	1/2	3/4	7/8	1	1 1/4		
<b>Steel Strength in Tension</b>										
Minimum Tensile Stress Area	$A_{se}$	in. <sup>2</sup>	0.078	0.142	0.225	0.334	0.462	0.606	0.969	
Tension Resistance of Steel — ASTM F1554, Grade 36		lb.	4,525	8,235	13,110	19,370	26,795	35,150	56,200	
Tension Resistance of Steel — ASTM F1554, Grade 55		lb.	5,850	10,650	16,950	25,050	34,650	45,450	72,675	
Tension Resistance of Steel — ASTM A193, Grade B7 <sup>7</sup>		lb.	9,750	17,750	28,250	41,750	57,750	75,750	121,125	
Tension Resistance of Steel — Stainless Steel ASTM A193, Grade B8 and B8M (Types 304 and 316)		lb.	4,445	8,095	12,880	19,040	26,335	34,540	55,235	
Tension Resistance of Steel — Stainless Steel ASTM F593 CW (Types 304 and 316)		lb.	7,800	14,200	22,600	28,390	39,270	51,510	82,365	
Tension Resistance of Steel — Stainless Steel ASTM A193, Grade B6 (Type 410)		lb.	8,580	15,620	24,860	36,740	50,820	66,580	106,590	
Strength Reduction Factor for Tension — Steel Failure	$\phi$	—	0.75 <sup>8</sup>							
<b>Concrete Breakout Strength in Tension (2,500 psi ≤ f'<sub>c</sub> ≤ 8,000 psi)</b>										
Effectiveness Factor for Cracked Concrete	$k_{cr}$	—	17							
Effectiveness Factor for Uncracked Concrete	$k_{un-cr}$	—	24							
Strength Reduction Factor — Concrete Breakout Failure in Tension	$\phi$	—	0.65 <sup>8</sup>							
<b>Bond Strength in Tension (2,500 psi ≤ f'<sub>c</sub> ≤ 8,000 psi)<sup>7</sup></b>										
Minimum Embedment	$h_{ef,min}$	in.	2 3/8	2 3/4	3 1/8	3 3/4	3 3/4	4	5	
Maximum Embedment	$h_{ef,max}$	in.	7 1/2	10	12 1/2	15	17 1/2	20	25	
Temperature Range A <sup>2, 4</sup>	Characteristic Bond Strength in Cracked Concrete <sup>3</sup>	$f_{t,cr}$	psi	1,448	1,402	1,355	1,310	1,265	1,219	1,128
	Characteristic Bond Strength									

Example Strength Design Data Table

### Allowable Load Tables

Under the IBC, allowable stress design (see p. 270) may be used for cast-in-place and post-installed adhesive and mechanical anchors installed into masonry or for gas/powder-actuated fasteners installed into concrete, masonry or steel.

SET-XP® Allowable Tension and Shear Loads for Threaded Rod and Rebar in the Top of Fully Grouted CMU Wall Construction <sup>1, 2, 4, 5, 6, 7, 9, 10, 11, 12</sup>					
Diameter (in.) or Rebar Size No.	Drill Bit Diameter (in.)	Minimum Embedment <sup>3</sup> (in.)	Allowable Load Based on Bond Strength <sup>7, 8</sup> (lb.)		
			Tension Load	Shear Perp.	Shear Parallel
<b>Threaded Rod Installed in the Top of CMU Wall</b>					
1/2	3/8	4 1/2	1,485	590	1,050
		12	2,440	665	1,625
3/8	3/4	5 1/2	1,700	565	1,435
		15	2,960	660	1,785
7/8	1	7 1/2	1,610	735	1,370
		21	4,760	670	1,375
<b>Rebar Installed in the Top of CMU Wall</b>					
#4	3/8	4 1/2	1,265	550	865
		12	2,715	465	1,280
#5	3/4	5 1/2	1,345	590	1,140
		15	3,090	590	1,285

1. Allowable load shall be the lesser of the bond values shown in this table and steel values, shown on page 63.
2. Allowable loads are for installation in the grouted CMU core opening.
3. Embedment depth shall be measured from the horizontal surface of the grouted CMU core opening on top of the masonry wall.

Example Allowable Load Table

# How to Use This Catalog

## Table Icon System

In order to facilitate easier identification of performance data, the following icon system has been incorporated into the sections of the catalog with multiple load tables. These icons will appear in the heading of the table to promote easier visual identification of the type of load, insert type and substrate addressed in the table. Icons are intended for quick identification. All specific information regarding suitability should be read from the table itself.

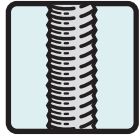

Threaded Rod

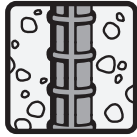

Rebar

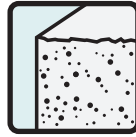

Normal-Weight  
Concrete



Lightweight  
Concrete

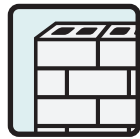

Concrete Block  
(CMU)



Lightweight Concrete  
over Metal Deck

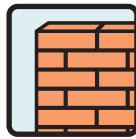

Unreinforced Brick  
(URM)

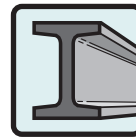

Steel

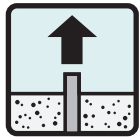

Tension Load

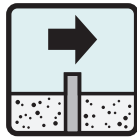

Shear Load

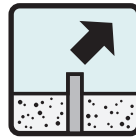

Oblique Load

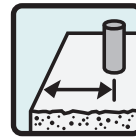

Edge Distance

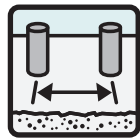

Spacing



Valid for  
International  
Building Code



Not Valid for  
International  
Building Code

# Important Information and General Notes

## General Notes

These general notes are provided to ensure proper installation of Simpson Strong-Tie Company Inc. products and must be followed fully.

- a. Simpson Strong-Tie Company Inc. reserves the right to change specifications, designs, and models without notice or liability for such changes. Please refer to [strongtie.com](http://strongtie.com) for the latest product updates, availability and load tables.
- b. Unless otherwise noted, dimensions are in inches and loads are in pounds.
- c. Do not overload, which will jeopardize the anchorage. Service loads shall not exceed published allowable loads. Factored loads shall not exceed design strengths calculated in accordance with published design data.
- d. Some hardened fasteners may experience premature failure if exposed to moisture. These fasteners are recommended to be used in dry interior applications.
- e. Do not weld products listed in this catalog. Some steel types have poor weldability and a tendency to crack when welded.

## Warning

Simpson Strong-Tie Company Inc. anchors, fasteners and structural connectors are designed and tested to provide specified design loads. To obtain optimal performance from Simpson Strong-Tie products and to achieve maximum design load, the products must be properly installed and used in accordance with the installation instructions and design limits provided by Simpson Strong-Tie. To ensure proper installation and use, designers and installers must carefully read the General Notes, General Instructions to the Installer and General Instructions to the Designer contained in this catalog, as well as consult the applicable catalog pages for specific product installation instructions and notes. Please always consult the Simpson Strong-Tie website at [strongtie.com](http://strongtie.com) for updates regarding all Simpson Strong-Tie products.

Proper product installation requires careful attention to all notes and instructions, including the following basic rules:

1. Be familiar with the application and correct use of the anchor, connector or fastener.
2. Follow all installation instructions provided in the catalog, website, *Product Guide* (S-A-PG) or any other Simpson Strong-Tie publication.
3. Follow all product-related warnings provided in the catalog, website or any other Simpson Strong-Tie publication.
4. Install anchors, structural connectors and fasteners in accordance with their intended use.
5. Install all anchors, structural connectors and fasteners per installation instructions provided by Simpson Strong-Tie.
6. When using power tools to install fasteners: (a) use proper fastener type for direct fastening tool; (b) use proper powder or gas loads; and (c) follow appropriate safety precautions as outlined in this catalog, on the website or in the tool Operator's Manual.

In addition to following the basic rules provided above as well as all notes, warnings and instructions provided in the catalog, installers, designers, engineers and consumers should consult the Simpson Strong-Tie website at [strongtie.com](http://strongtie.com) to obtain additional design and installation information, including:

- Instructional builder/contractor training kits containing an instructional video, an instructor guide and a student guide in both English and Spanish;
- Information on workshops Simpson Strong-Tie conducts at various training centers throughout the United States;
- Product-specific installation videos;
- Specialty catalogs;
- Code reports – Simpson Strong-Tie® Code Report Finder;
- Technical fliers, bulletins and engineering letters;
- Master format specifications;
- Safety data sheets;
- Corrosion information;
- Adhesive cartridge estimator;
- Simpson Strong-Tie Software and Web Applications at [strongtie.com/softwareandwebapplications/category](http://strongtie.com/softwareandwebapplications/category); and
- Answers to frequently asked questions and technical topics.

Failure to fully follow all of the notes and instructions provided by Simpson Strong-Tie may result in improper installation of products. Improperly installed products may not perform to the specifications set forth in this catalog and may reduce a structure's ability to resist the movement, stress and loading that occur from gravity loads as well as impact events such as earthquakes and high-velocity winds.

Simpson Strong-Tie Company Inc. does not guarantee the performance or safety of products that are modified, improperly installed or not used in accordance with the design and load limits set forth in this catalog.

## Important Information and General Notes

### General Instructions for the Installer

These general instructions for the installer are provided to ensure the proper selection and installation of Simpson Strong-Tie products and must be followed carefully. They are in addition to the specific design and installation instructions and notes provided for each particular product, all of which should be consulted prior to and during the installation of Simpson Strong-Tie products.

- a. Do not modify Simpson Strong-Tie products as the performance of modified products may be substantially weakened. Simpson Strong-Tie will not warrant or guarantee the performance of such modified products.
- b. Do not alter installation procedures from those set forth in this catalog.
- c. Drill holes for post-installed anchors with carbide-tipped drills meeting the diameter requirements of ANSI B212.15 (shown in the table to the right). A properly sized hole is critical to the performance of post-installed anchors. Rotary-hammered drills with light, high-frequency impact are recommended for drilling holes. When holes are to be drilled in archaic or hollow base materials, the drill should be set to "rotation only" mode.
- d. Failure to apply the recommended installation torque can result in excessive displacement of the anchor under load or premature failure of the anchor. These anchors will lose pre-tension after setting due to pre-load relaxation. See p. 263 for more information.
- e. Do not disturb, make attachments, or apply load to adhesive anchors prior to the full cure of the adhesive.
- f. Use proper safety equipment.

Finished Diameters for Rotary and Rotary-Hammer Carbide-Tipped Concrete Drills per ANSI B212.15

Nominal Drill Bit Diameter (in.)	Tolerance Range Minimum (in.)	Tolerance Range Maximum (in.)
1/8	0.134	0.140
5/32	0.165	0.171
3/16	0.198	0.206
7/32	0.229	0.237
1/4	0.260	0.268
5/16	0.327	0.335
3/8	0.390	0.398
7/16	0.458	0.468
1/2	0.520	0.530
9/16	0.582	0.592
5/8	0.650	0.660
11/16	0.713	0.723
3/4	0.775	0.787
13/16	0.837	0.849
27/32	0.869	0.881
7/8	0.905	0.917
15/16	0.968	0.980
1	1.030	1.042
1 1/8	1.160	1.175
1 1/16	1.223	1.238
1 1/4	1.285	1.300
1 5/16	1.352	1.367
1 3/8	1.410	1.425
1 7/16	1.472	1.487
1 1/2	1.535	1.550
1 9/16	1.588	1.608
1 5/8	1.655	1.675
1 3/4	1.772	1.792
2	2.008	2.028

## Important Information and General Notes

# Additional Instructions for the Installer for Gas- and Powder-Actuated Fastening

Before operating any Simpson Strong-Tie gas- or powder-actuated tool, you must read and understand the Operator's Manual and be trained by an authorized instructor in the operation of the tool. Simpson Strong-Tie recommends you read and fully understand the safety guidelines of the tool you use. To become a Certified Operator of Simpson Strong-Tie gas- and powder-actuated tools, you must pass a test and receive a certified operator card (for online powder-actuated tool test, visit [strongtie.com/products/anchoring-systems/technical-notes/direct-fastening-systems/powder-actuated-operators-exam](https://strongtie.com/products/anchoring-systems/technical-notes/direct-fastening-systems/powder-actuated-operators-exam)). Test and Operator's Manual are included with each tool kit. Extra copies may be obtained by contacting Simpson Strong-Tie at (800) 999-5099.

To avoid serious injury or death:

- a. Always make sure that the operators and bystanders wear safety glasses. Hearing and head protection is also recommended.
- b. Always post warning signs within the area when gas- or powder-actuated tools are in use. Signs should state "Tool in Use."
- c. Always store gas- and powder-actuated tools unloaded. Store tools and powder loads in a locked container out of reach of children.
- d. Never place any part of your body over the front muzzle of the tool, even if no fastener is present. The fastener, pin or tool piston can cause serious injury or death in the event of accidental discharge.
- e. Never attempt to bypass or circumvent any of the safety features on a gas- or powder-actuated tool.
- f. Always keep the tool pointed in a safe direction.
- g. Always keep your finger off the trigger.
- h. Always keep the tool unloaded until ready to use.
- i. Always hold the tool perpendicular (90°) to the fastening surface to prevent ricocheting fasteners. Use the spall guard whenever possible.
- j. Never attempt to fasten into thin, brittle or very hard materials such as glass, tile or cast iron as these materials are inappropriate. Conduct a pre-punch test to determine base material adequacy.
- k. Never attempt to fasten into soft material such as drywall or wood. Fastening through soft materials into appropriate base material may be allowed if the application is appropriate.
- l. Never attempt to fasten to a spalled, cracked or uneven surface.
- m. Re-driving of pins is not recommended.

## Important Information and General Notes

### General Instructions for the Designer

These general instructions for the designer are provided to ensure the proper selection and installation of Simpson Strong-Tie® products and must be followed carefully. They are in addition to the specific design and installation instructions and notes provided for each particular product, all of which should be consulted prior to and during the design process.

- a. The term “Designer” used throughout this catalog is intended to mean a licensed/certified building design professional, a licensed professional engineer or a licensed architect.
- b. All connected members and related elements shall be designed by the designer and must have sufficient strength (bending, shear, etc.) to resist the design loads.
- c. When the allowable stress design method is used, the design service load shall not exceed the published allowable loads reduced by load-adjustment factors for temperature, spacing and edge distance.
- d. When the strength design method is used, the factored loads shall not exceed the design strengths calculated in accordance with the published design data.
- e. Simpson Strong-Tie strongly recommends the following addition to construction drawings and specifications: “Simpson Strong-Tie products are specifically required to meet the structural calculations. Before substituting another brand, confirm load capacity based on reliable published testing data or calculations. The designer should evaluate and give written approval for substitution prior to installation.”
- f. Where used in this catalog, “IBC” refers to the 2018 International Building Code, and “ACI 318” refers to ACI 318-14 Building Code Requirements for Structural Concrete. Local and/or regional building codes may require meeting special conditions. Building codes often require special inspection of post-installed anchors installed in concrete and masonry. For compliance with these requirements, contact the local and/or building authority having jurisdiction. Except where mandated by code, Simpson Strong-Tie products do not require special inspection.
- g. Allowable loads and design strengths are determined from test results, calculations and experience. These are guide values for sound base materials with known properties. Due to variation in base materials and site conditions, site-specific testing should be conducted if exact performance in a specific base material at a specific site must be known.
- h. Unless stated otherwise, tests conducted to derive performance information were performed in members with thickness that comply with the appropriate acceptance criteria during testing and assessment. Anchoring into members thinner than recommended in this catalog requires the evaluation and judgment of a qualified designer.
- i. Tests are conducted with anchors installed perpendicular ( $\pm 6^\circ$ ) from a vertical reference to the surface of the base material. Deviations can result in anchor bending stresses that may reduce the load-carrying capacity of the anchor.
- j. Allowable loads and design strengths do not consider bending stresses due to shear loads applied with large eccentricities.
- k. Metal anchors and fasteners will corrode and may lose load-carrying capacity when installed in corrosive environments or exposed to corrosive materials. See p. 261.
- l. Mechanical anchors should not be installed into concrete that is less than 7 days old. The allowable loads and design strengths of mechanical anchors that are installed into concrete less than 28 days old should be based on the actual compressive strength of the concrete at the time of installation.
- m. Nominal embedment depth (“embedment depth”) is the distance from the surface of the base material to the installed end of the anchor and is measured prior to application of an installation torque (if applicable). Effective embedment depth is the distance from the surface of the base material to the deepest point at which the load is transferred to the base material.
- n. Drill bits shall meet the diameter requirements of ANSI B212.15. For adhesive anchor installations in oversized holes, see p. 264. For adhesive anchor installations into core-drilled holes, see p. 265.
- o. Threaded-rod inserts for adhesive anchors shall be oil-free UNC fully threaded steel. Bare steel, zinc plating, mechanical galvanizing or hot-dip galvanizing coatings are acceptable.
- p. Allowable loads and design strengths are generally based on testing of adhesive anchors installed into dry holes. For installations into damp, wet and submerged environments, see p. 265.
- q. ACI 318 states that adhesive anchors should not be installed into concrete that is less than 21 days old. For information on adhesive anchors installed into concrete less than 21 days old, see p. 264.
- r. Adhesive anchors can be affected by elevated base material temperature. See p. 266.
- s. Anchors are permitted to support fire-resistant construction provided at least one of the following conditions is fulfilled: (a) anchors are used to resist wind or seismic forces only; (b) anchors that support gravity-load-bearing structural elements are within a fire-resistive envelope or a fire-resistive membrane, are protected by approved fire-resistive materials, or have been evaluated for resistance to fire exposure in accordance with recognized standards; or (c) anchors are used to support non-structural elements.
- t. Exposure to some chemicals may degrade the bond strength of adhesive anchors. Refer to the product description for chemical resistance information or refer to see p. 268.
- u. Use of rodless pneumatic tools to dispense single-tube, coaxial adhesive cartridges is prohibited.



## Important Information and General Notes

### Limited Warranty

Simpson Strong-Tie Company Inc. warrants catalog products to be free from defects in material or manufacturing. Simpson Strong-Tie Company Inc. products are further warranted for adequacy of design when used in accordance with design limits in this catalog and when properly specified, installed and maintained. This warranty does not apply to uses not in compliance with specific applications and installations set forth in this catalog, or to non-catalog or modified products, or to deterioration due to environmental conditions.

Simpson Strong-Tie® anchors, fasteners and connectors are designed to enable structures to resist the movement, stress and loading that results from impact events such as earthquakes and high-velocity winds. Other Simpson Strong-Tie products are designed to the load capacities and uses listed in this catalog. Properly installed Simpson Strong-Tie products will perform in accordance with the specifications set forth in the applicable Simpson Strong-Tie catalog. Additional performance limitations for specific products may be listed on the applicable catalog pages.

Due to the particular characteristics of potential impact events, the specific design and location of the structure, the building materials

used, the quality of construction, and the condition of the soils involved, damage may nonetheless result to a structure and its contents even if the loads resulting from the impact event do not exceed Simpson Strong-Tie catalog specifications and Simpson Strong-Tie connectors are properly installed in accordance with applicable building codes.

All warranty obligations of Simpson Strong-Tie Company Inc. shall be limited, at the discretion of Simpson Strong-Tie Company Inc., to repair or replacement of the defective part. These remedies shall constitute the sole obligation of Simpson Strong-Tie Company Inc. and the sole remedy of purchaser under this warranty. In no event will Simpson Strong-Tie Company Inc. be responsible for incidental, consequential, or special loss or damage, however caused.

**This warranty is expressly in lieu of all other warranties, expressed or implied, including warranties of merchantability or fitness for a particular purpose, all such other warranties being hereby expressly excluded. This warranty may change periodically — consult our website [strongtie.com](http://strongtie.com) for current information.**

### Terms and Conditions of Sale

#### Product Use

Products in this catalog are designed and manufactured for the specific purposes shown, and should not be used with other connectors not approved by a qualified designer. Modifications to products or changes in installations should only be made by a qualified designer. The performance of such modified products or altered installations is the sole responsibility of the designer.

#### Indemnity

Customers or designers modifying products or installations, or designing non-catalog products for fabrication by Simpson Strong-Tie Company Inc. shall, regardless of specific instructions to the user, indemnify, defend and hold harmless Simpson Strong-Tie Company Inc. for any and all claimed loss or damage occasioned in whole or in part by non-catalog or modified products.

#### Non-Catalog and Modified Products

Consult Simpson Strong-Tie Company Inc. for applications for which there is no catalog product, or for connectors for use in hostile environments, with excessive wood shrinkage, or with abnormal loading or erection requirements.

Non-catalog products must be designed by the customer and will be fabricated by Simpson Strong-Tie in accordance with customer specifications.

Simpson Strong-Tie cannot and does not make any representations regarding the suitability of use or load-carrying capacities of non-catalog products. Simpson Strong-Tie provides no warranty, express or implied, on non-catalog products. F.O.B. Shipping Point unless otherwise specified.

# Anchor Software and Web Apps

## Rebar Development Length Calculator

Rebar Development Length Calculator is a web application that supports the design of post-installed rebar in concrete applications by calculating the necessary tension and compression development lengths required in accordance with ACI 318-19 / ACI 318-14.

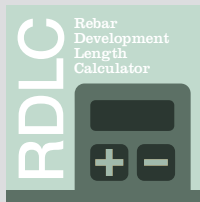

The screenshot shows the web application interface for the Rebar Development Length Calculator. It is divided into several sections:

- Splice Information:** Includes 'Lap Splice Application' (set to 'No') and 'Splice Class' (set to 'Class A').
- Concrete Information:** Includes 'Concrete Type' (set to 'NWC') and 'Concrete Compressive Strength,  $f'_c$  (psi)' (set to '2,500').
- Rebar Information:** Includes 'Rebar Coating' (set to 'Uncoated / Zinc coated') and 'Rebar Spacing (Center-to-Center),  $S$ ' (set to '8 in'). It also has a 'Minimum Clear Cover,  $C_{min}$ ' (set to '3 in').
- Seismic Design Category:** Set to 'A-B'.

On the right side, there are two diagrams illustrating 'Lap Splice Application' in concrete, showing 'Existing cast-in-place reinforcing bar' and 'Post-installed reinforcing bar' with 'Development length' indicated. At the bottom right, there are 'RESTART' and 'CALCULATE' buttons.

Visit: [strongtie.com/softwareandwebapplications/category](https://strongtie.com/softwareandwebapplications/category).

## Adhesive Cartridge Estimator

With the Adhesive Cartridge Estimator you can easily estimate how much adhesive you will need for your project, including threaded rod and rebar doweling, and crack injection.



The screenshot shows the web application interface for the Adhesive Cartridge Estimator (ACE). It is divided into 'INPUT' and 'OUTPUT' sections.

**INPUT:**

- Condition:** Includes 'Threaded Rod and Rebar Doweling' and 'Crack Injection'.
- Insert:** Includes 'Threaded Rod', 'Rebar', 'Plastic Screen Tube', and 'Steel Screen Tube'. A dropdown menu for 'Insert Diameter (Rod Size)' is set to '5/8" (Ø125)'.
- Adhesive Anchor:** Includes 'AT-XP', 'ET-HP', 'SET-3G', and 'SET-XP'. 'SET-3G' is selected.

**OUTPUT:**

- Job Tally:** A table showing the estimated adhesive volume for different jobs.
- Product Information:** Details for 'SET-3G High-Strength Epoxy Adhesive', including images of the product and a description.

Action	Job	SET3G10 9.8 oz (fourtridges)	SET3G22- N 22 oz (fourtridges)	User inputs
	Job 1	0.05	0.00	Insert: Threaded Rod, Insert Diameter: 5/8", Adhesive Anchor: SET-3G, DR: 80 Diameter: 11/16", Number Installations: 1, Coverage Factor: 0%, Embedment Depth: 1", Water Filled Holes: No
Total		0.05	0.00	

Visit: [strongtie.com/softwareandwebapplications/category](https://strongtie.com/softwareandwebapplications/category).

# Anchor Designer™ Software for ACI 318, ETAG and CSA

Simpson Strong-Tie® Anchor Designer Software is the latest anchorage design tool for structural engineers to satisfy the strength design provisions and methodologies. Anchor Designer will quickly and accurately analyze an existing design or suggest anchorage solutions based upon user-defined design elements in cracked and uncracked concrete conditions.

The real-time design is visually represented in a fully-interactive 3D graphic user interface, supports Imperial and Metric-sized Simpson Strong-Tie mechanical and adhesive anchors, and offers cast-in-place anchor solutions. Anchor Designer can calculate single anchor solutions or with multiple anchors in a single plate. Anchor locations are fully customizable to assist engineers in complex design conditions.

## Features include:

- Design standards: ACI 318-14 Chapter 17 / ACI 318-11 Appendix D, CAN / CSA A23.3 Annex D, ETAG 001 Annex C or EOTA TR029.
- Customizable anchor pattern.
- Easy-to-use menus.
- Ability to calculate single anchor model or to calculate multiple anchor models at once.
- Multi-lingual options include English, German, French, Spanish, Polish and Danish languages.
- Rectangular, circular, L-shape and T-shape base plate geometries with the option to include slotted holes.
- And much more!

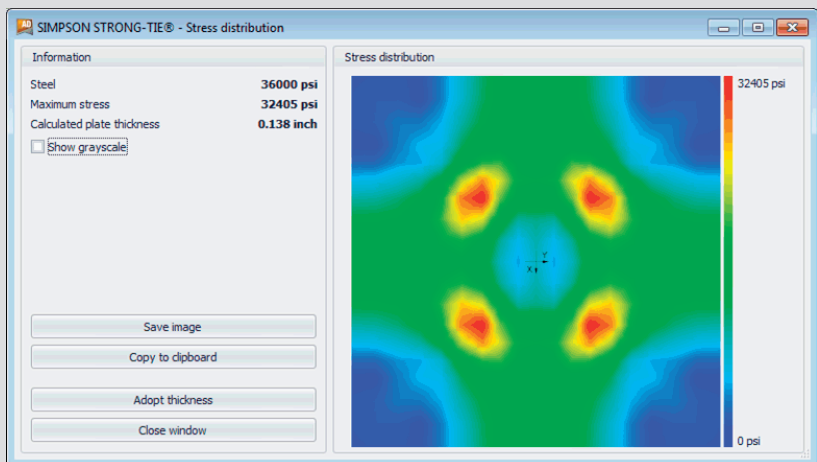
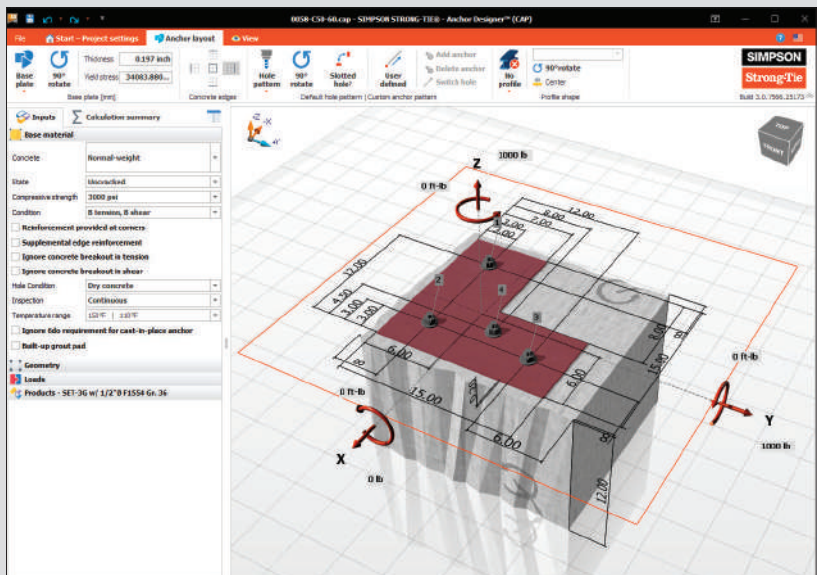

Visit: [strongtie.com/softwareandwebapplications/category](http://strongtie.com/softwareandwebapplications/category).



# Adhesive Anchors

---

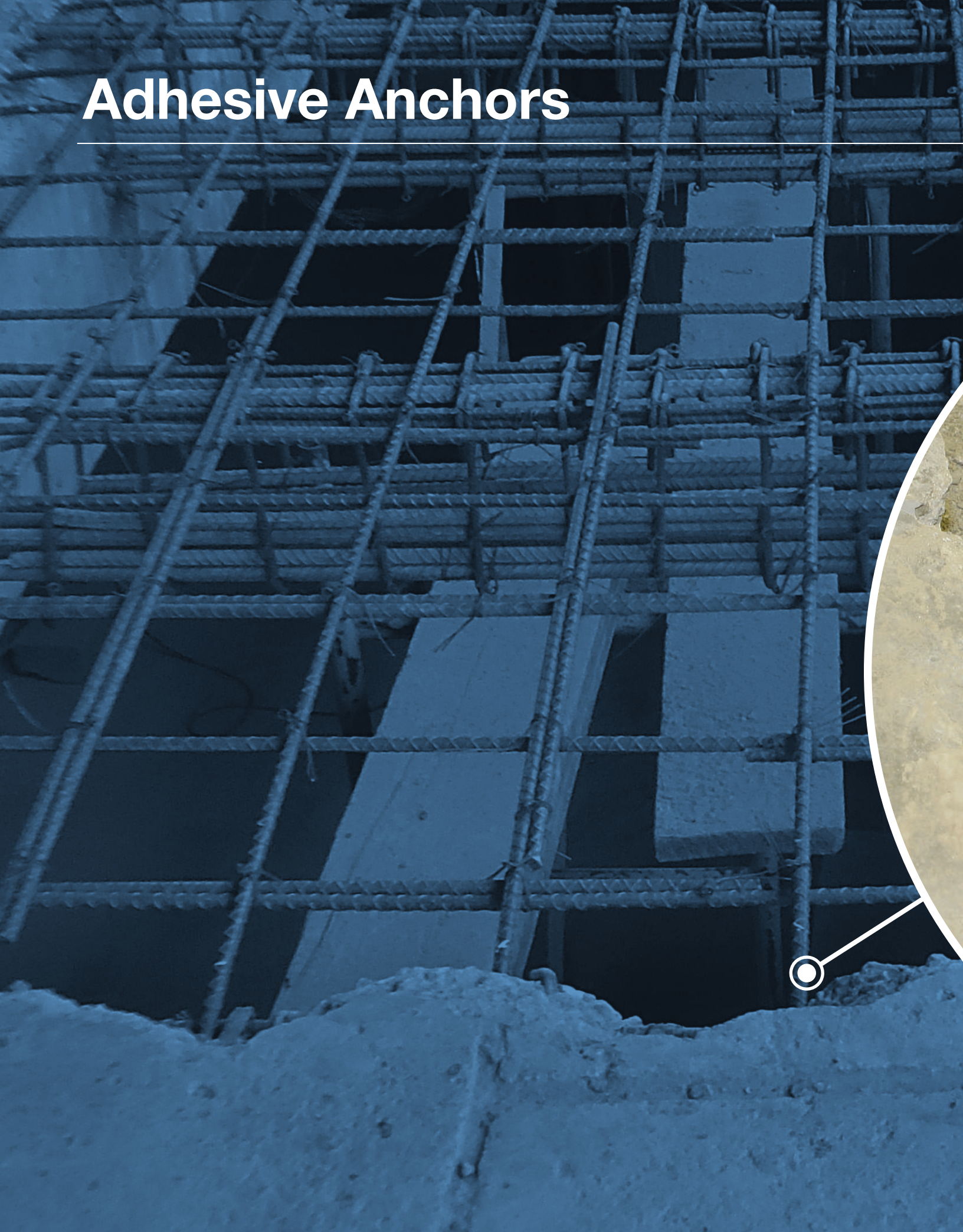



SIMPSON Strong-Tie

SET-3G

Epoxy

High-Strength Anchoring Adhesive

Adhesivo para sujetadores de alta resistencia

Adhésif d'ancrage à haute résistance

22 fl oz  
650 mL

MADE IN USA

strongtie.com

# SET-3G™ High-Strength Epoxy Adhesive

SET-3G is the latest innovation in epoxy anchoring adhesives with high design strength and proven performance. SET-3G is a 1:1 ratio, two-component, anchoring adhesive for concrete (cracked and uncracked). SET-3G installs and performs in a variety of environmental conditions and temperature extremes.

## Features

- Exceptional performance — superior bond strengths permit ductile solutions in high seismic areas
- Design flexibility — improved sustained load performance at elevated temperature
- Jobsite versatility — can be specified for all base material conditions when in-service temperatures range from -40°F (-40°C) to 176°F (80°C)
- Recognized per ICC ES AC308 for post-installed rebar development and splice length design provisions
- Code listed for installation with the Speed Clean™ DXS, dustless drilling system without further hole cleaning

## Product Information

Mix Ratio/Type	1:1 epoxy
Mixed Color	Gray
Base Materials	Concrete — cracked and uncracked
Base Material Conditions	Dry, water-saturated, water-filled
Anchor Type	Threaded rod or rebar
Substrate Installation Temperature	40°F (4°C) to 100°F (38°C)
In-Service Temperature Range	-40°F (-40°C) to 176°F (80°C)
Storage Temperature	45°F (7°C) and 90°F (32°C)
Shelf Life	24 months
Volatile Organic Compound (VOC)	2 g/L
Chemical Resistance	See pp. 268–269
Manufactured in the USA using global materials	

## Test Criteria

SET-3G has been tested in accordance with ICC-ES AC308, ACI 355.4 and applicable ASTM test methods.

## Code Reports, Standards and Compliance

Concrete — ICC-ES ESR-4057 (including post-installed rebar connections and City of LA); FL15730.

Masonry — coming 2021.

ASTM C881 and AASHTO M235 — Types I/IV and II/IV, Grade 3, Class B&C.

UL Certification — CDPH Standard Method v1.2.

NSF/ANSI/CAN 61 (216 in.<sup>2</sup> / 1,000 gal.).

## SET-3G Adhesive Cartridge System

Model No.	Capacity (ounces)	Cartridge Type	Carton Quantity	Dispensing Tool(s)	Mixing Nozzle <sup>3</sup>
SET3G10 <sup>1</sup>	8.5	Coaxial	12	CDT10S	EMN22I
SET3G22-N <sup>1</sup>	22	Side-by-side	10	EDT22S, EDTA22P, EDTA22CKT	
SET3G56	56	Side-by-side	6	EDTA56P	

1. One EMN22I mixing nozzle and one extension are supplied with each cartridge.

2. Cartridge estimation guidelines are available at [strongtie.com/softwareandwebapplications/category](http://strongtie.com/softwareandwebapplications/category).

3. Use only Simpson Strong-Tie® mixing nozzles in accordance with Simpson Strong-Tie instructions. Modification or improper use of mixing nozzle may impair SET-3G adhesive performance.

4. Use of rodless pneumatic tools to dispense single-tube, coaxial adhesive cartridges is prohibited.



SET-3G Adhesive

## Installation Instructions

Installation instructions are located at the following locations: pp. 64–67; product packaging; or [strongtie.com/set3g](http://strongtie.com/set3g).

- Hole cleaning brushes are located on p. 68.

# SET-3G™ High-Strength Epoxy Adhesive

## SET-3G Cure Schedule<sup>1,2</sup>

Concrete Temperature		Gel Time	Cure Time
(°F)	(°C)	(min.)	(hr.)
40	4	120	192
50	10	75	72
60	16	50	48
70	21	35	24
90	32	25	24
100	38	15	24

For SI: 1°F = (°C x 9/5) + 32.

- For water-saturated concrete and water-filled holes, the cure times shall be doubled.
- For installation of anchors in concrete where the temperature is below 70°F (21°C), the adhesive must be conditioned to a minimum temperature of 70°F (21°C).

## SET-3G Typical Properties

Property		Class B	Class C	Test Method
		(40°–60°F)	(> 60°F)	
Consistency		Non-sag	Non-sag	ASTM C881
Bond Strength, Slant Shear	Hardened to Hardened Concrete, 2-Day Cure <sup>1</sup>	3,700 psi	3,300 psi	ASTM C882
	Hardened to Hardened Concrete, 14-Day Cure <sup>1</sup>	3,850 psi	3,350 psi	
	Fresh to Hardened Concrete, 14-Day Cure <sup>2</sup>	2,750 psi	2,750 psi	
Compressive Yield Strength, 7-Day Cure <sup>2</sup>		13,000 psi	15,350 psi	ASTM D695
Compressive Modulus, 7-Day Cure <sup>2</sup>		650,000 psi	992,000 psi	ASTM D695
Heat Deflection Temperature, 7-Day Cure <sup>2</sup>		147°F (64°C)		ASTM D648
Glass Transition Temperature, 7-Day Cure <sup>2</sup>		149°F (65°C)		ASTM E1356
Decomposition Temperature, 24-Hour Cure <sup>2</sup>		500°F (260°C)		ASTM E2550
Water Absorption, 24-Hours, 7-Day Cure <sup>2</sup>		0.13%		ASTM D570
Shore D Hardness, 24-Hour Cure <sup>2</sup>		84		ASTM D2240
Linear Coefficient of Shrinkage, 7-Day Cure <sup>2</sup>		0.002 in./in.		ASTM D2566
Coefficient of Thermal Expansion <sup>2</sup>		2.3 x 10 <sup>-5</sup> in./in.°F		ASTM C531

- Material and curing conditions: Class B at 40° ± 2°F, Class C at 60° ± 2°F.
- Material and curing conditions: 73° ± 2°F.

## SET-3G Installation Information and Additional Data for Threaded Rod and Rebar<sup>1</sup>



Characteristic	Symbol	Units	Nominal Anchor Diameter $d_a$ (in.) / Rebar Size						
			3/8 / #3	1/2 / #4	5/8 / #5	3/4 / #6	7/8 / #7	1 / #8	1 1/4 / #10
<b>Installation Information</b>									
Drill Bit Diameter for Threaded Rod	$d_{hole}$	in.	7/16	9/16	1 1/16	7/8	1	1 1/8	1 3/8
Drill Bit Diameter for Rebar	$d_{hole}$	in.	1/2	5/8	3/4	7/8	1	1 1/8	1 3/8
Maximum Tightening Torque	$T_{inst}$	ft.-lb.	15	30	60	100	125	150	200
Minimum Embedment Depth	$h_{ef, min}$	in.	2 3/8	2 3/4	3 1/8	3 1/2	3 3/4	4	5
Maximum Embedment Depth	$h_{ef, max}$	in.	7 1/2	10	12 1/2	15	17 1/2	20	25
Minimum Concrete Thickness	$h_{min}$	in.	$h_{ef} + 1 1/4$			$h_{ef} + 2d_{hole}$			
Critical Edge Distance	$c_{ac}$	in.	See footnote 2						
Minimum Edge Distance	$c_{min}$	in.	1 3/4						2 3/4
Minimum Anchor Spacing	$s_{min}$	in.	1	2 1/2	3			6	

1. The information presented in this table is to be used in conjunction with the design criteria of ACI 318-14 and ACI 318-11.

2.  $c_{ac} = h_{ef} (\tau_{k, uncr} / 1,160)^{0.4} \times [3.1 - 0.7(h/h_{ef})]$ , where:

$$[h/h_{ef}] \leq 2.4$$

$\tau_{k, uncr}$  = the characteristic bond strength in uncracked concrete, given in the tables that follow  $\leq k_{uncr} ((h_{ef} \times f'_c)^{0.5} / (\pi \times d_a))$

$h$  = the member thickness (inches)

$h_{ef}$  = the embedment depth (inches)

$d_a$  = nominal anchor diameter

\* See p. 12 for an explanation of the load table icons.

# SET-3G™ Design Information — Concrete

SET-3G Tension Strength Design Data for Threaded Rod<sup>1,8</sup>



Characteristic		Symbol	Units	Nominal Rod Diameter (in.)							
				3/8	1/2	5/8	3/4	7/8	1	1 1/4	
<b>Steel Strength in Tension</b>											
Minimum Tensile Stress Area		$A_{se}$	in. <sup>2</sup>	0.078	0.142	0.226	0.334	0.462	0.606	0.969	
Tension Resistance of Steel — ASTM F1554, Grade 36		$N_{sa}$	lb.	4,525	8,235	13,110	19,370	26,795	35,150	56,200	
Tension Resistance of Steel — ASTM F1554, Grade 55				5,850	10,650	16,950	25,050	34,650	45,450	72,675	
Tension Resistance of Steel — ASTM A193, Grade B7				9,750	17,750	28,250	41,750	57,750	75,750	121,125	
Tension Resistance of Steel — Stainless Steel ASTM A193, Grade B8 and B8M (Types 304 and 316)				4,445	8,095	12,880	19,040	26,335	34,540	55,235	
Tension Resistance of Steel — Stainless Steel ASTM F593 CW (Types 304 and 316)				7,800	14,200	22,600	28,390	39,270	51,510	82,365	
Tension Resistance of Steel — Stainless Steel ASTM A193, Grade B6 (Type 410)				8,580	15,620	24,860	36,740	50,820	66,660	106,590	
Strength Reduction Factor for Tension — Steel Failure		$\phi$	—	0.75 <sup>5</sup>							
<b>Concrete Breakout Strength in Tension (2,500 psi ≤ f<sub>c</sub> ≤ 8,000 psi)</b>											
Effectiveness Factor for Cracked Concrete		$k_{c,cr}$	—	17							
Effectiveness Factor for Uncracked Concrete		$k_{c,uncr}$	—	24							
Strength Reduction Factor — Concrete Breakout Failure in Tension		$\phi$	—	0.65 <sup>6</sup>							
<b>Bond Strength in Tension (2,500 psi ≤ f<sub>c</sub> ≤ 8,000 psi)<sup>7</sup></b>											
Minimum Embedment		$h_{ef,min}$	in.	2 3/8	2 3/4	3 1/8	3 1/2	3 3/4	4	5	
Maximum Embedment		$h_{ef,max}$	in.	7 1/2	10	12 1/2	15	17 1/2	20	25	
Continuous Inspection	Temperature Range A <sup>2,4</sup>	Characteristic Bond Strength in Cracked Concrete <sup>9</sup>	$\tau_{k,cr}$	psi	1,448	1,402	1,356	1,310	1,265	1,219	1,128
		Characteristic Bond Strength in Uncracked Concrete <sup>9</sup>	$\tau_{k,uncr}$	psi	2,357	2,260	2,162	2,064	1,967	1,868	1,672
	Temperature Range B <sup>3,4</sup>	Characteristic Bond Strength in Cracked Concrete <sup>9</sup>	$\tau_{k,cr}$	psi	1,201	1,163	1,125	1,087	1,050	1,012	936
		Characteristic Bond Strength in Uncracked Concrete <sup>9</sup>	$\tau_{k,uncr}$	psi	1,957	1,876	1,795	1,713	1,632	1,551	1,388
	Anchor Category		Dry Concrete	—	1						
	Strength Reduction Factor		Dry Concrete	$\phi_{dry,ci}$	0.65 <sup>10</sup>						
	Anchor Category		Water-Saturated Concrete, or Water-Filled Hole	—	3			2			
	Strength Reduction Factor		Water-Saturated Concrete, or Water-Filled Hole	$\phi_{wet,ci}$	0.45 <sup>10</sup>			0.55 <sup>10</sup>			
Periodic Inspection	Temperature Range A <sup>2,4</sup>	Characteristic Bond Strength in Cracked Concrete <sup>9</sup>	$\tau_{k,cr}$	psi	1,346	1,304	1,356	1,310	1,265	1,219	1,128
		Characteristic Bond Strength in Uncracked Concrete <sup>9</sup>	$\tau_{k,uncr}$	psi	2,192	2,102	2,162	2,064	1,967	1,868	1,672
	Temperature Range B <sup>3,4</sup>	Characteristic Bond Strength in Cracked Concrete <sup>9</sup>	$\tau_{k,cr}$	psi	1,117	1,082	1,125	1,087	1,050	1,012	936
		Characteristic Bond Strength in Uncracked Concrete <sup>9</sup>	$\tau_{k,uncr}$	psi	1,820	1,744	1,795	1,713	1,632	1,551	1,388
	Anchor Category		Dry Concrete	—	2			1			
	Strength Reduction Factor		Dry Concrete	$\phi_{dry,pi}$	0.55 <sup>10</sup>			0.65 <sup>10</sup>			
	Anchor Category		Water-Saturated Concrete, or Water-Filled Hole	—	3						
	Strength Reduction Factor		Water-Saturated Concrete, or Water-Filled Hole	$\phi_{wet,pi}$	0.45 <sup>10</sup>						
Reduction Factor for Seismic Tension		$\alpha_{N,seis}$ <sup>11</sup>	—	1.0	0.9	1.0	1.0	1.0	1.0	1.0	

- The information presented in this table is to be used in conjunction with the design criteria of ACI 318-14 and ACI 318-11.
- Temperature Range A: Maximum short-term temperature = 160°F, maximum long-term temperature = 110°F.
- Temperature Range B: Maximum short-term temperature = 176°F, maximum long-term temperature = 110°F.
- Short-term concrete temperatures are those that occur over short intervals (diurnal cycling). Long-term temperatures are roughly constant over significant periods of time.
- The tabulated value of  $\phi$  applies when the load combinations of ACI 318-14 5.3 or ACI 318-11 9.2 are used. If the load combinations of ACI 318-11 Appendix C are used, refer to ACI 318-11 D.4.4 to determine the appropriate value of  $\phi$ .
- The tabulated value of  $\phi$  applies when both the load combinations of ACI 318-14 5.3, or ACI 318-11 9.2 are used and the requirements of ACI 318-14 17.3.3 (c) or ACI 318-11 D.4.3 (c), as applicable, for Condition B are met. If the load combinations of ACI 318-11 Appendix C are used, refer to ACI 318 D.4.4 (c) for Condition B to determine the appropriate value of  $\phi$ .
- Bond strength values shown are for normal-weight concrete having a compressive strength of  $f'_c = 2,500$  psi. For higher compressive strengths up to 8,000 psi, the tabulated characteristic bond strength may be increased by a factor of  $(f'_c/2,500)^{0.35}$  for uncracked concrete and a factor of  $(f'_c/2,500)^{0.24}$  for cracked concrete.
- For lightweight concrete, the modification factor for bond strength shall be as given in ACI 318-14 17.2.6 or ACI 318-11 D.3.6, as applicable, where applicable.
- Characteristic bond strength values are for sustained loads, including dead and live loads.
- The tabulated value of  $\phi$  applies when both the load combinations of ACI 318-14 5.3, or ACI 318-11 9.2 are used and the requirements of ACI 318-14 17.3.3 (c) or ACI 318-11 D.4.3 (c), as applicable, for Condition B are met. If the load combinations of ACI 318-11 Appendix C are used, refer to ACI 318 D.4.4(c) for Condition B to determine the appropriate value of  $\phi$ .
- For anchors installed in regions assigned to Seismic Design Category C, D, E or F, the bond strength values must be multiplied by  $\alpha_{N,seis}$ .

\* See p. 12 for an explanation of the load table icons.



# SET-3G™ Design Information — Concrete

## SET-3G Tension Strength Design Data for Rebar<sup>1,8</sup>



Characteristic		Symbol	Units	Rebar Size							
				#3	#4	#5	#6	#7	#8	#10	
<b>Steel Strength in Tension</b>											
Minimum Tensile Stress Area		$A_{se}$	in. <sup>2</sup>	0.11	0.20	0.31	0.44	0.60	0.79	1.27	
Tension Resistance of Steel — Rebar (ASTM A615 Grade 60)		$N_{sa}$	lb.	9,900	18,000	27,900	39,600	54,000	71,100	114,300	
Tension Resistance of Steel — Rebar (ASTM A706 Grade 60)				8,800	16,000	24,800	35,200	48,000	63,200	101,600	
Strength Reduction Factor for Tension — Steel Failure		$\phi$	—	0.75 <sup>9</sup>							
<b>Concrete Breakout Strength in Tension (2,500 psi ≤ f'<sub>c</sub> ≤ 8,000 psi)</b>											
Effectiveness Factor for Cracked Concrete		$k_{c,cr}$	—	17							
Effectiveness Factor for Uncracked Concrete		$k_{c,uncr}$	—	24							
Strength Reduction Factor — Concrete Breakout Failure in Tension		$\phi$	—	0.65 <sup>9</sup>							
<b>Bond Strength in Tension (2,500 psi ≤ f'<sub>c</sub> ≤ 8,000 psi)<sup>7</sup></b>											
Minimum Embedment		$h_{ef,min}$	in.	2¾	2¾	3⅞	3½	3¾	4	5	
Maximum Embedment		$h_{ef,max}$	in.	7½	10	12½	15	17½	20	25	
Continuous Inspection	Temperature Range A <sup>2,4</sup>	Characteristic Bond Strength in Cracked Concrete <sup>9</sup>	$\tau_{k,cr}$	psi	1,448	1,402	1,356	1,310	1,265	1,219	1,128
		Characteristic Bond Strength in Uncracked Concrete <sup>9</sup>	$\tau_{k,uncr}$	psi	2,269	2,145	2,022	1,898	1,774	1,651	1,403
	Temperature Range B <sup>3,4</sup>	Characteristic Bond Strength in Cracked Concrete <sup>9</sup>	$\tau_{k,cr}$	psi	1,201	1,163	1,125	1,087	1,050	1,012	936
		Characteristic Bond Strength in Uncracked Concrete <sup>9</sup>	$\tau_{k,uncr}$	psi	1,883	1,781	1,678	1,575	1,473	1,370	1,165
	Anchor Category		Dry Concrete	—	1						
	Strength Reduction Factor		Dry Concrete	$\phi_{dry,ci}$	0.65 <sup>10</sup>						
	Anchor Category		Water-Saturated Concrete, or Water-Filled Hole	—	3			2			
	Strength Reduction Factor		Water-Saturated Concrete, or Water-Filled Hole	$\phi_{wet,ci}$	0.45 <sup>10</sup>			0.55 <sup>10</sup>			
Periodic Inspection	Temperature Range A <sup>2,4</sup>	Characteristic Bond Strength in Cracked Concrete <sup>9</sup>	$\tau_{k,cr}$	psi	1,346	1,304	1,356	1,310	1,265	1,219	1,128
		Characteristic Bond Strength in Uncracked Concrete <sup>9</sup>	$\tau_{k,uncr}$	psi	2,110	1,995	2,022	1,898	1,774	1,651	1,403
	Temperature Range B <sup>3,4</sup>	Characteristic Bond Strength in Cracked Concrete <sup>9</sup>	$\tau_{k,cr}$	psi	1,117	1,082	1,125	1,087	1,050	1,012	936
		Characteristic Bond Strength in Uncracked Concrete <sup>9</sup>	$\tau_{k,uncr}$	psi	1,751	1,656	1,678	1,575	1,473	1,370	1,165
	Anchor Category		Dry Concrete	—	2			1			
	Strength Reduction Factor		Dry Concrete	$\phi_{dry,pi}$	0.55 <sup>10</sup>			0.65 <sup>10</sup>			
	Anchor Category		Water-Saturated Concrete, or Water-Filled Hole	—	3						
	Strength Reduction Factor		Water-Saturated Concrete, or Water-Filled Hole	$\phi_{wet,pi}$	0.45 <sup>10</sup>						
Reduction Factor for Seismic Tension		$\alpha_{N,seis}$ <sup>11</sup>	—	1.0	1.0	1.0	1.0	1.0	1.0	1.0	

- The information presented in this table is to be used in conjunction with the design criteria of ACI 318-14 and ACI 318-11.
- Temperature Range A: Maximum short-term temperature = 160°F, maximum long-term temperature = 110°F.
- Temperature Range B: Maximum short-term temperature = 176°F, maximum long-term temperature = 110°F.
- Short-term concrete temperatures are those that occur over short intervals (diurnal cycling). Long-term temperatures are roughly constant over significant periods of time.
- The tabulated value of  $\phi$  applies when the load combinations of ACI 318-14 5.3 or ACI 318-11 9.2 are used. If the load combinations of ACI 318-11 Appendix C are used, refer to ACI 318-11 D.4.4 to determine the appropriate value of  $\phi$ .
- The tabulated value of  $\phi$  applies when both the load combinations of ACI 318-14 5.3, or ACI 318-11 9.2 are used and the requirements of ACI 318-14 17.3.3 (c) or ACI 318-11 D.4.3 (c), as applicable, for Condition B are met. If the load combinations of ACI 318-11 Appendix C are used, refer to ACI 318 D.4.4(c) for Condition B to determine the appropriate value of  $\phi$ .
- Bond strength values shown are for normal-weight concrete having a compressive strength of  $f'_c = 2,500$  psi. For higher compressive strengths up to 8,000 psi, the tabulated characteristic bond strength may be increased by a factor of  $(f'_c/2,500)^{0.36}$  for uncracked concrete and a factor of  $(f'_c/2,500)^{0.25}$  for cracked concrete.
- For lightweight concrete, the modification factor for bond strength shall be as given in ACI 318-14 17.2.6 or ACI 318-11 D.3.6, as applicable, where applicable.
- Characteristic bond strength values are for sustained loads, including dead and live loads.
- The tabulated value of  $\phi$  applies when both the load combinations of ACI 318-14 5.3, or ACI 318-11 9.2 are used and the requirements of ACI 318-14 17.3.3 (c) or ACI 318-11 D.4.3 (c), as applicable, for Condition B are met. If the load combinations of ACI 318-11 Appendix C are used, refer to ACI 318 D.4.4(c) for Condition B to determine the appropriate value of  $\phi$ .
- For anchors installed in regions assigned to Seismic Design Category C, D, E or F, the bond strength values must be multiplied by  $\alpha_{N,seis}$ .

\* See p. 12 for an explanation of the load table icons.

# SET-3G™ Design Information — Concrete

## SET-3G Shear Strength Design Data for Threaded Rod<sup>1</sup>



Characteristic	Symbol	Units	Nominal Rod Diameter (in.)						
			3/8	1/2	5/8	3/4	7/8	1	1 1/4
<b>Steel Strength in Shear</b>									
Minimum Shear Stress Area	$A_{se}$	in. <sup>2</sup>	0.078	0.142	0.226	0.334	0.462	0.606	0.969
Shear Resistance of Steel — ASTM F1554, Grade 36	$V_{sa}$	lb.	2,715	4,940	7,865	11,625	16,080	21,090	33,720
Shear Resistance of Steel — ASTM F1554, Grade 55			3,510	6,390	10,170	15,030	20,790	27,270	43,605
Shear Resistance of Steel — ASTM A193, Grade B7			5,850	10,650	16,950	25,050	34,650	45,450	72,675
Reduction factor for Seismic Shear — Carbon Steel	$\alpha_{V_{seis}}^4$	—	0.75					1.0	
Shear Resistance of Steel — Stainless Steel ASTM A193, Grade B8 and B8M (Types 304 and 316)	$V_{sa}$	lb.	2,665	4,855	7,730	11,425	15,800	20,725	33,140
Shear Resistance of Steel — Stainless Steel ASTM F593 CW (Types 304 and 316)			4,680	8,520	13,560	17,035	23,560	30,905	49,420
Shear Resistance of Steel — Stainless Steel ASTM A193, Grade B6 (Type 410)			5,150	9,370	14,915	22,040	30,490	40,000	63,955
Reduction factor for Seismic Shear — Stainless Steel	$\alpha_{V_{seis}}^4$	—	0.80		0.75			1.0	
Strength Reduction Factor for Shear — Steel Failure	$\phi$	—	0.65 <sup>2</sup>						
<b>Concrete Breakout Strength in Shear</b>									
Outside Diameter of Anchor	$d_a$	in.	0.375	0.5	0.625	0.75	0.875	1	1.25
Load-Bearing Length of Anchor in Shear	$l_e$	in.	Min. of $h_{ef}$ and 8 times anchor diameter						
Strength Reduction Factor for Shear — Breakout Failure	$\phi$	—	0.70 <sup>3</sup>						
<b>Concrete Pryout Strength in Shear/</b>									
Coefficient for Pryout Strength	$k_{cp}$	in.	1.0 for $h_{ef} < 2.50"$ ; 2.0 for $h_{ef} \geq 2.50"$						
Strength Reduction Factor for Shear — Breakout Failure	$\phi$	—	0.70 <sup>3</sup>						

- The information presented in this table is to be used in conjunction with the design criteria of ACI 318-14 and ACI 318-11.
- The tabulated value of  $\phi$  applies when the load combinations of ACI 318-14 5.3 or ACI 318-11 9.2 are used. If the load combinations of ACI 318-11 Appendix C are used, refer to ACI 318-11 D.4.4 to determine the appropriate value of  $\phi$ .
- The tabulated value of  $\phi$  applies when both the load combinations of ACI 318-14 5.3, or ACI 318-11 9.2 are used and the requirements of ACI 318-14 17.3.3 (c) or ACI 318-11 D.4.3 (c), as applicable, for Condition B are met. If the load combinations of ACI 318-11 Appendix B are used, refer to ACI 318 D.4.4 (c) for Condition B to determine the appropriate value of  $\phi$ .
- The values of  $V_{sa}$  are applicable for both cracked concrete and uncracked concrete. For anchors installed in regions assigned to Seismic Design Category C, D, E or F,  $V_{sa}$  must be multiplied by  $\alpha_{V_{seis}}$  for the corresponding anchor steel type.

\* See p. 12 for an explanation of the load table icons.

# SET-3G™ Design Information — Concrete



## SET-3G Shear Strength Design Data for Rebar<sup>1</sup>

Characteristic	Symbol	Units	Nominal Rod Diameter (in.)						
			#3	#4	#5	#6	#7	#8	#10
<b>Steel Strength in Shear</b>									
Minimum Shear Stress Area	$A_{se}$	in. <sup>2</sup>	0.110	0.200	0.310	0.440	0.600	0.790	1.270
Shear Resistance of Steel — Rebar (ASTM A615 Grade 60)	$V_{sa}$	lb.	5,940	10,800	16,740	23,760	32,400	42,660	68,580
Shear Resistance of Steel — Rebar (ASTM A706 Grade 60)			5,280	9,600	14,880	21,120	28,800	37,920	60,960
Reduction Factor for Seismic Shear — Rebar (ASTM A615 Grade 60)	$\alpha_{V_{seis}}^A$	—	0.60						0.8
Reduction Factor for Seismic Shear — Rebar (ASTM A706 Grade 60)			0.60						0.8
Strength Reduction Factor for Shear — Steel Failure	$\phi$	—	0.65 <sup>2</sup>						
<b>Concrete Breakout Strength in Shear</b>									
Outside Diameter of Anchor	$d_a$	in.	0.375	0.5	0.625	0.75	0.875	1	1.25
Load-Bearing Length of Anchor in Shear	$l_e$	in.	Min. of $h_{ef}$ and 8 times anchor diameter						
Strength Reduction Factor for Shear — Breakout Failure	$\phi$	—	0.70 <sup>3</sup>						
<b>Concrete Pryout Strength in Shear</b>									
Coefficient for Pryout Strength	$k_{cp}$	in.	1.0 for $h_{ef} < 2.50"$ ; 2.0 for $h_{ef} \geq 2.50"$						
Strength Reduction Factor for Shear — Breakout Failure	$\phi$	—	0.70 <sup>3</sup>						

- The information presented in this table is to be used in conjunction with the design criteria of ACI 318-14 and ACI 318-11.
- The tabulated value of  $\phi$  applies when the load combinations of ACI 318-14 5.3 or ACI 318-11 9.2 are used. If the load combinations of ACI 318-11 Appendix C are used, refer to ACI 318-11 D.4.4 to determine the appropriate value of  $\phi$ .
- The tabulated value of  $\phi$  applies when both the load combinations of ACI 318-14 5.3 or ACI 318-11 9.2 are used and the requirements of ACI 318-14 17.3.3 (c) or ACI 318-11 D.4.3 (c), as applicable, for Condition B are met. If the load combinations of ACI 318-11 Appendix C are used, refer to ACI 318 D.4.4 (c) for Condition B to determine the appropriate value of  $\phi$ .
- The values of  $V_{sa}$  are applicable for both cracked concrete and uncracked concrete. For anchors installed in regions assigned to Seismic Design Category C, D, E or F,  $V_{sa}$  must be multiplied by  $\alpha_{V_{seis}}$  for the corresponding anchor steel type.

For additional load tables, visit [strongtie.com/set3g](http://strongtie.com/set3g).



## Anchor Designer™ Software for ACI 318, ETAG and CSA

Simpson Strong-Tie® Anchor Designer software accurately analyzes existing design or suggests anchor solutions based on user-defined design elements in cracked and uncracked concrete conditions.

<sup>\*</sup> See p. 12 for an explanation of the load table icons.

# SET-3G™ Design Information — Concrete

SET-3G is code listed under IBC/IRC for cracked and uncracked concrete per ICC-ES ESR-4057.

In March 2020, the evaluation report was updated for SET-3G to be an equivalent to cast-in-place reinforcing bars governed by ACI 318 and IBC Chapter 19.

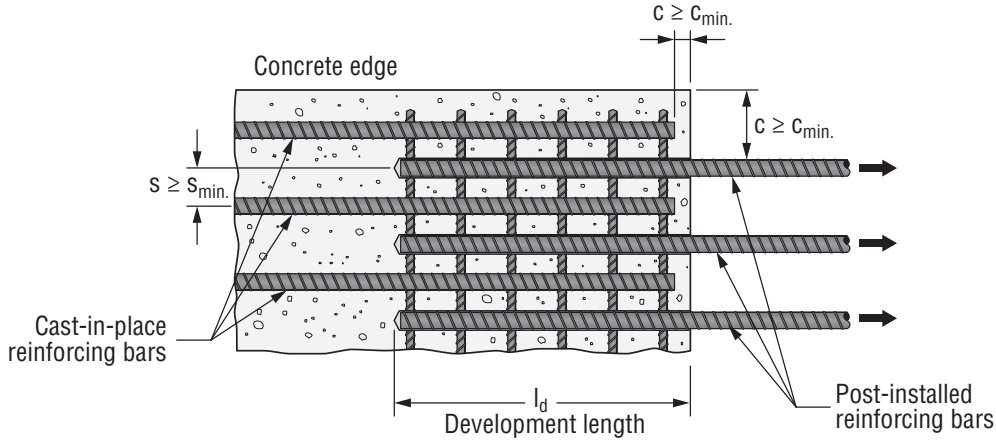

SET-3G Development Length for Rebar Dowel

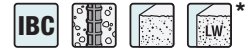

Rebar Size	Drill Bit Diameter (in.)	Clear Cover, in. (mm)	Development Length, in. (mm)				
			$f'_c = 2,500$ psi (17.2 MPa) Concrete	$f'_c = 3,000$ psi (20.7 MPa) Concrete	$f'_c = 4,000$ psi (27.6 MPa) Concrete	$f'_c = 6,000$ psi (41.4 MPa) Concrete	$f'_c = 8,000$ psi (55.2 MPa) Concrete
#3	½	1.125 (29)	12 (305)	12 (305)	12 (305)	12 (305)	12 (305)
#4	5/8	1.125 (29)	14.4 (366)	14 (356)	12 (305)	12 (305)	12 (305)
#5	¾	1.125 (29)	18 (457)	17 (432)	14.2 (361)	12 (305)	12 (305)
#6	7/8	1.125 (29)	21.6 (549)	20 (508)	17.1 (434)	14 (356)	13 (330)
#7	1	2.30 (58)	31.5 (800)	29 (737)	25 (635)	21 (533)	18 (457)
#8	1 1/8	2.30 (58)	36 (914)	33 (838)	28.5 (724)	24 (610)	21 (533)
#9	1 3/8	2.30 (58)	40.5 (1,029)	38 (965)	32 (813)	27 (686)	23 (584)
#10	1 1/2	2.30 (58)	45 (1,143)	42 (1,067)	35.6 (904)	30 (762)	26 (660)
#11	1 3/4	2.30 (58)	51 (1,295)	47 (1,194)	41 (1,041)	33 (838)	29 (737)

1. Tabulated development lengths are for static, wind and seismic load cases in Seismic Design Category A and B. Development lengths in Seismic Design Category C through F must comply with ACI 318-14 Chapter 18 or ACI 318-11 Chapter 21, as applicable.
2. Rebar is assumed to be ASTM A615 Grade 60 or A706 ( $f_y = 60,000$  psi). For rebar with a higher yield strength, multiply tabulated values by  $f_y/60,000$  psi.
3. Concrete is assumed to be normal-weight concrete. For lightweight concrete, multiply tabulated values by 1.33.
4. Tabulated values assume bottom cover less than 12" cast below rebars ( $\Psi_1 = 1.0$ ).
5. Uncoated rebar must be used.
6. The value of  $K_{tr}$  is assumed to be 0. Refer to ACI318-14 Section 25.4.2.3 or ACI 318-11 Section 12.2.3.

\* See p. 12 for an explanation of the load table icons.

# Anchor Web App



## Rebar Development Length Calculator

Rebar Development Length Calculator is a web application that supports the design of post-installed rebar in concrete applications by calculating the necessary tension and compression development lengths required in accordance with ACI 318-19 / ACI 318-14.

### Splice Information

Lap Splice Application:

Splice Class:

---

### Concrete Information

Concrete Type:

Concrete Compressive Strength,  $f'_c$  (psi):

---

### Rebar Information

Rebar Coating:

Rebar Spacing (Center-to-Center),  $S$ :  in

Minimum Clear Cover,  $C_{min}$ :  in

---

### Seismic Design Category

Seismic Design Category:

Lap Splice Application

Visit: [strongtie.com/softwareandwebapplications/category](https://strongtie.com/softwareandwebapplications/category).

# SET-XP® High-Strength Epoxy Adhesive

SET-XP is an epoxy-based high-strength anchoring adhesive. SET-XP is a 1:1 ratio, two-component anchoring adhesive for anchoring and doweling into concrete (cracked and uncracked) and masonry (uncracked) applications.

## Features

- Design flexibility — permitted for sustained load performance at elevated temperature
- Jobsite versatility — can be specified for dry and damp conditions when in-service temperatures range from -40°F (-40°C) to 150°F (65°C)
- Recognized per AC308 to be used for rebar development and splice length design provisions of ACI 318
- Code listed for installation with the Speed Clean™ DXS system without any further cleaning

## Product Information

Mix Ratio/Type	1:1 epoxy
Mixed Color	Teal
Base Materials	Concrete — Cracked and uncracked Masonry — Uncracked
Base Material Conditions	Dry, water-saturated
Anchor Type	Threaded rod or rebar
Substrate Installation Temperature	50°F (4°C) to 110°F (38°C)
In-Service Temperature Range	-40°F (-40°C) to 150°F (65°C)
Storage Temperature	45°F (7°C) and 90°F (32°C)
Shelf Life	24 months
Volatile Organic Compound (VOC)	3 g/L
Chemical Resistance	See pp. 268–269
Manufactured in the USA using global materials	

## Test Criteria

SET-XP has been tested in accordance with ICC-ES AC308, AC58, ACI 355.4 and applicable ASTM test methods.

## Code Reports, Standards and Compliance

Concrete — ICC-ES ESR-2508 (including post-installed rebar and City of LA Report); FL15730.

Masonry — IAPMO UES ER-265 (including City of LA Report); FL16230.  
ASTM C881 and AASHTO M235 — Types I/IV and II/IV, Grade 3, Class C.  
UL Certification — CDPH Standard Method v1.2.  
NSF/ANSI/CAN 61 (216 in.<sup>2</sup> / 1,000 gal.)

## Installation Instructions

Installation instructions are located at the following locations: pp. 64–67; product packaging; or [strongtie.com/setxp](http://strongtie.com/setxp).

- Hole cleaning brushes are located on p. 68.

## SET-XP Cartridge System

Model No.	Capacity (ounces)	Cartridge Type	Carton Quantity	Dispensing Tool(s)	Mixing Nozzle <sup>3</sup>
SET-XP10 <sup>4</sup>	8.5	Single	12	CDT10S	EMN22I
SET-XP22-N <sup>4</sup>	22	Side-by-Side	10	EDT22S, EDTA22P, EDTA22CKT	
SET-XP56	56	Side-by-Side	6	EDTA56P	

1. Cartridge estimation guidelines are available at [strongtie.com/softwareandwebapplications/category](http://strongtie.com/softwareandwebapplications/category).
2. Detailed information on dispensing tools, mixing nozzles and other adhesive accessories is available at [strongtie.com](http://strongtie.com).
3. Use only Simpson Strong-Tie mixing nozzles in accordance with Simpson Strong-Tie instructions. Modification or improper use of mixing nozzle may impair SET-XP adhesive performance.
4. One EMN22I mixing nozzle and one nozzle extension are supplied with each cartridge.
5. Use of rodless pneumatic tools to dispense single-tube, coaxial adhesive cartridges is prohibited.



SET-XP Adhesive

# SET-XP® High-Strength Epoxy Adhesive

## SET-XP Cure Schedule

Base Material Temperature		Gel Time (minutes)	Cure Time (hrs.)
°F	°C		
50	10	75	72
60	16	60	48
70	21	45	24
90	32	35	24
110	43	20	24

For water-saturated concrete, the cure times must be doubled.

## SET-XP Typical Properties

Property		Class C	Test Method
		(> 60°F)	
Consistency		non-sag	ASTM C881
Bond Strength, Slant Shear	Hardened to Hardened Concrete, 2-Day Cure <sup>1</sup>	2,900 psi	ASTM C882
	Hardened to Hardened Concrete, 14-Day Cure <sup>1</sup>	3,200 psi	
	Fresh to Hardened Concrete, 14-Day Cure <sup>2</sup>	2,000 psi	
Compressive Yield Strength, 7-Day Cure <sup>2</sup>		14,100 psi	ASTM D695
Compressive Modulus, 7-Day Cure <sup>2</sup>		612,000 psi	ASTM D695
Heat Deflection Temperature, 7-Day Cure <sup>2</sup>		136°F (58°C)	ASTM D648
Glass Transition Temperature, 7-Day Cure <sup>2</sup>		126°F (52°C)	ASTM E1356
Decomposition Temperature, 24-Hour Cure <sup>2</sup>		500°F (260°C)	ASTM E2550
Water Absorption, 24-Hours, 7-Day Cure <sup>2</sup>		0.10%	ASTM D570
Shore D Hardness, 24-Hour Cure <sup>2</sup>		84	ASTM D2240
Linear Coefficient of Shrinkage, 7-Day Cure <sup>2</sup>		0.002 in./in.	ASTM D2566
Coefficient of Thermal Expansion <sup>2</sup>		2.4 x 10 <sup>-5</sup> in./in.°F	ASTM C531

1. Material and curing conditions: 60° ± 2°F.

2. Material and curing conditions: 73° ± 2°F.

## SET-XP Installation Information and Additional Data for Threaded Rod and Rebar<sup>1</sup>



Characteristic	Symbol	Units	Nominal Anchor Diameter (in.) / Rebar Size							
			3/8 / #3	1/2 / #4	5/8 / #5	3/4 / #6	7/8 / #7	1 / #8	1 1/4 / #10	
<b>Installation Information</b>										
Drill Bit Diameter	$d_{hole}$	in.	1/2	5/8	3/4	7/8	1	1 1/8	1 3/8	
Maximum Tightening Torque	$T_{inst}$	ft.-lb.	10	20	30	45	60	80	125	
Permitted Embedment Depth Range	Minimum	$h_{ef}$	in.	2 3/8	2 3/4	3 1/8	3 1/2	3 3/4	4	5
	Maximum	$h_{ef}$	in.	7 1/2	10	12 1/2	15	17 1/2	20	25
Minimum Concrete Thickness	$h_{min}$	in.	$h_{ef} + 5d_{hole}$							
Critical Edge Distance <sup>2</sup>	$c_{ac}$	in.	See footnote 2							
Minimum Edge Distance	$c_{min}$	in.	1 3/4						2 3/4	
Minimum Anchor Spacing	$s_{min}$	in.	3						6	

1. The information presented in this table is to be used in conjunction with the design criteria of ACI 318-14 and ACI 318-11.

2.  $c_{ac} = h_{ef} (\tau_{k,uncr}/1,160)^{0.4} \times [3.1 - 0.7(h/h_{ef})]$ , where:

$$[h/h_{ef}] \leq 2.4$$

$\tau_{k,uncr}$  = the characteristic bond strength in uncracked concrete, given in the tables that follow  $\leq k_{uncr} ((h_{ef} \times f'_c)^{0.5} / (\pi \times d_{hole}))$

$h$  = the member thickness (inches)

$h_{ef}$  = the embedment depth (inches)

\* See p. 12 for an explanation of the load table icons.

# SET-XP® Design Information — Concrete

## SET-XP Tension Strength Design Data for Threaded Rod<sup>1</sup>

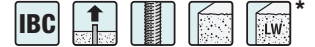

Characteristic		Symbol	Units	Nominal Anchor Diameter (in.)							
				3/8	1/2	5/8	3/4	7/8	1	1 1/4	
<b>Steel Strength in Tension</b>											
Threaded Rod	Minimum Tensile Stress Area	$A_{se}$	in <sup>2</sup>	0.078	0.142	0.226	0.334	0.462	0.606	0.969	
	Tension Resistance of Steel — ASTM F1554, Grade 36	$N_{sa}$	lb.	4,525	8,235	13,110	19,370	26,795	35,150	56,200	
	Tension Resistance of Steel — ASTM A193, Grade B7			9,750	17,750	28,250	41,750	57,750	75,750	121,125	
	Tension Resistance of Steel — Type 410 Stainless (ASTM A193, Grade B6)			8,580	15,620	24,860	36,740	50,820	66,660	106,590	
	Tension Resistance of Steel — Type 304 and 316 Stainless (ASTM A193, Grade B8 and B8M)			4,445	8,095	12,880	19,040	26,335	34,540	55,235	
	Strength Reduction Factor — Steel Failure			$\phi$	—	0.75 <sup>7</sup>					
<b>Concrete Breakout Strength in Tension (2,500 psi ≤ f<sub>c</sub> ≤ 8,000 psi)<sup>12</sup></b>											
Effectiveness Factor — Uncracked Concrete		$k_{uncr}$	—	24							
Effectiveness Factor — Cracked Concrete		$k_{cr}$	—	17							
Strength Reduction Factor — Breakout Failure		$\phi$	—	0.65 <sup>9</sup>							
<b>Bond Strength in Tension (2,500 psi ≤ f<sub>c</sub> ≤ 8,000 psi)<sup>12</sup></b>											
Uncracked Concrete <sup>2,3,4</sup>	Characteristic Bond Strength <sup>5,13</sup>	$\tau_{k,uncr}$	psi	770	1,150	1,060	970	885	790	620	
	Permitted Embedment Depth Range	Minimum	$h_{ef}$	in.	2 3/8	2 3/4	3 1/8	3 1/2	3 3/4	4	5
		Maximum	$h_{ef}$	in.	7 1/2	10	12 1/2	15	17 1/2	20	25
Cracked Concrete <sup>2,3,4</sup>	Characteristic Bond Strength <sup>5,10,11,13</sup>	$\tau_{k,cr}$	psi	595	510	435	385	355	345	345	
	Permitted Embedment Depth Range	Minimum	$h_{ef}$	in.	3	4	5	6	7	8	10
		Maximum	$h_{ef}$	in.	7 1/2	10	12 1/2	15	17 1/2	20	25
<b>Bond Strength in Tension — Bond Strength Reduction Factors for Continuous Special Inspection</b>											
Strength Reduction Factor — Dry Concrete		$\phi_{dry,ci}$	—	0.65 <sup>8</sup>							
Strength Reduction Factor — Water-Saturated Concrete — $h_{ef} \leq 12d_a$		$\phi_{sat,ci}$	—	0.55 <sup>8</sup>			0.45 <sup>8</sup>				
Additional Factor for Water-Saturated Concrete — $h_{ef} \leq 12d_a$		$K_{sat,ci}$ <sup>6</sup>	—	1					0.84		
Strength Reduction Factor — Water-Saturated Concrete — $h_{ef} > 12d_a$		$\phi_{sat,ci}$	—	0.45 <sup>8</sup>							
Additional Factor for Water-Saturated Concrete — $h_{ef} > 12d_a$		$k_{sat,ci}$ <sup>6</sup>	—	0.57							
<b>Bond Strength in Tension — Bond Strength Reduction Factors for Periodic Special Inspection</b>											
Strength Reduction Factor — Dry Concrete		$\phi_{dry,pi}$	—	0.55 <sup>8</sup>							
Strength Reduction Factor — Water-Saturated Concrete — $h_{ef} \leq 12d_a$		$\phi_{sat,pi}$	—	0.45 <sup>8</sup>							
Additional Factor for Water-Saturated Concrete — $h_{ef} \leq 12d_a$		$K_{sat,pi}$ <sup>6</sup>	—	1		0.93			0.71		
Strength Reduction Factor — Water-Saturated Concrete — $h_{ef} > 12d_a$		$\phi_{sat,pi}$	—	0.45 <sup>8</sup>							
Additional Factor for Water-Saturated Concrete — $h_{ef} > 12d_a$		$K_{sat,pi}$ <sup>6</sup>	—	0.48							

- The information presented in this table is to be used in conjunction with the design criteria of ACI 318-14 or ACI 318-11.
- Temperature Range: Maximum short-term temperature of 150°F. Maximum long-term temperature of 110°F.
- Short-term concrete temperatures are those that occur over short intervals (diurnal cycling).
- Long-term concrete temperatures are constant temperatures over a significant time period.
- For anchors that only resist wind or seismic loads, bond strengths may be increased by 72%.
- In water-saturated concrete, multiply  $\tau_{k,uncr}$  and  $\tau_{k,cr}$  by  $K_{sat}$ .
- The value of  $\phi$  applies when the load combinations of ACI 318-14 5.3 or ACI 318-11 Section 9.2 are used. If the load combinations of ACI 318 Appendix C are used, refer to ACI 318-11 D.4.4 to determine the appropriate value of  $\phi$ .
- The value of  $\phi$  applies when both the load combinations of ACI 318-14 5.3 or ACI 318-11 Section 9.2 are used and the requirements of ACI 318-14 17.3.3 or ACI 318-11 D.4.4 (c) for Condition B are met. If the load combinations of ACI 318 Appendix C are used, refer to ACI 318-11 D.4.4 to determine the appropriate value of  $\phi$ .
- The value of  $\phi$  applies when both the load combinations of ACI 318-14 5.3 or ACI 318-11 Section 9.2 are used and the requirements of ACI 318-14 17.3.3 or ACI 318-11 D.4.4 (c) for Condition B are met. If the load combinations of ACI 318-11 Section 9.2 are used and the requirements of ACI 318-11 D.4.4 (c) for Condition A are met, refer to ACI 318-11 D.4.4 to determine the appropriate value of  $\phi$ . If the load combinations of ACI 318 Appendix C are used, refer to ACI 318-11 D.4.5 to determine the appropriate value of  $\phi$ .
- For anchors installed in regions assigned to Seismic Design Category C, D, E or F, the bond strength values for 7/8" anchors must be multiplied by  $\alpha_{N,seis} = 0.80$ .
- For anchors installed in regions assigned to Seismic Design Category C, D, E or F, the bond strength values for 1" anchors must be multiplied by  $\alpha_{N,seis} = 0.92$ .
- The values of  $f'_c$  used for calculation purposes must not exceed 8,000 psi (55.1 MPa) for uncracked concrete. The value of  $f'_c$  used for calculation purposes must not exceed 2,500 psi (17.2 MPa) for tension resistance in cracked concrete.

\* See p. 12 for an explanation of the load table icons.



# SET-XP® Design Information — Concrete

## SET-XP Tension Strength Design Data for Rebar<sup>1</sup>



Characteristic		Symbol	Units	Rebar Size							
				#3	#4	#5	#6	#7	#8	#10	
<b>Steel Strength in Tension</b>											
Rebar	Minimum Tensile Stress Area	$A_{se}$	in <sup>2</sup>	0.11	0.2	0.31	0.44	0.6	0.79	1.23	
	Tension Resistance of Steel — Rebar (ASTM A615 Grade 60)	$N_{sa}$	lb.	9,900	18,000	27,900	39,600	54,000	71,100	110,700	
	Strength Reduction Factor — Steel Failure	$\phi$	—	0.65 <sup>7</sup>							
<b>Concrete Breakout Strength in Tension (2,500 psi ≤ f<sub>c</sub> ≤ 8,000 psi)<sup>10</sup></b>											
Effectiveness Factor — Uncracked Concrete		$k_{uncr}$	—	24							
Effectiveness Factor — Cracked Concrete		$k_{cr}$	—	17							
Strength Reduction Factor — Breakout Failure		$\phi$	—	0.65 <sup>9</sup>							
<b>Bond Strength in Tension (2,500 psi ≤ f<sub>c</sub> ≤ 8,000 psi)<sup>10</sup></b>											
Uncracked Concrete <sup>2,3,4</sup>	Characteristic Bond Strength <sup>5,11</sup>	$\tau_{k,uncr}$	psi	895	870	845	820	795	770	720	
	Permitted Embedment Depth Range	Minimum	$h_{ef}$	in.	2¾	2¾	3½	3½	3¾	4	5
		Maximum	$h_{ef}$	in.	7½	10	12½	15	17½	20	25
Cracked Concrete <sup>2,3,4</sup>	Characteristic Bond Strength <sup>5,11</sup>	$\tau_{k,cr}$	psi	365	735	660	590	515	440	275	
	Permitted Embedment Depth Range	Minimum	$h_{ef}$	in.	3	4	5	6	7	8	10
		Maximum	$h_{ef}$	in.	7½	10	12½	15	17½	20	25
<b>Bond Strength in Tension — Bond Strength Reduction Factors for Continuous Special Inspection</b>											
Strength Reduction Factor — Dry Concrete		$\phi_{dry,ci}$	—	0.65 <sup>8</sup>							
Strength Reduction Factor — Water-Saturated Concrete – $h_{ef} \leq 12d_a$		$\phi_{sat,ci}$	—	0.55 <sup>8</sup>			0.45 <sup>8</sup>				
Additional Factor for Water-Saturated Concrete – $h_{ef} \leq 12d_a$		$K_{sat,ci}$ <sup>6</sup>	—	1					0.84		
Strength Reduction Factor — Water-Saturated Concrete – $h_{ef} > 12d_a$		$\phi_{sat,ci}$	—	0.45 <sup>8</sup>							
Additional Factor for Water-Saturated Concrete – $h_{ef} > 12d_a$		$K_{sat,ci}$ <sup>6</sup>	—	0.57							
<b>Bond Strength in Tension — Bond Strength Reduction Factors for Periodic Special Inspection</b>											
Strength Reduction Factor — Dry Concrete		$\phi_{dry,pi}$	—	0.55 <sup>8</sup>							
Strength Reduction Factor — Water-Saturated Concrete – $h_{ef} \leq 12d_a$		$\phi_{sat,pi}$	—	0.45 <sup>8</sup>							
Additional Factor for Water-Saturated Concrete – $h_{ef} \leq 12d_a$		$K_{sat,pi}$ <sup>6</sup>	—	1		0.93			0.71		
Strength Reduction Factor — Water-Saturated Concrete – $h_{ef} > 12d_a$		$\phi_{sat,pi}$	—	0.45 <sup>8</sup>							
Additional Factor for Water-Saturated Concrete – $h_{ef} > 12d_a$		$K_{sat,pi}$ <sup>6</sup>	—	0.48							

- The information presented in this table is to be used in conjunction with the design criteria of ACI 318-14 or ACI 318-11.
- Temperature Range: Maximum short-term temperature of 150°F. Maximum long-term temperature of 110°F.
- Short-term concrete temperatures are those that occur over short intervals (diurnal cycling).
- Long-term concrete temperatures are constant temperatures over a significant time period.
- For anchors that only resist wind or seismic loads, bond strengths may be increased by 72%.
- In water-saturated concrete, multiply  $\tau_{k,uncr}$  and  $\tau_{k,cr}$  by  $K_{sat}$ .
- The value of  $\phi$  applies when the load combinations of ACI 318-14 5.3 or ACI 318-11 Section 9.2 are used. If the load combinations of ACI 318 Appendix C are used, refer to ACI 318-11 D.4.4 to determine the appropriate value of  $\phi$ .
- The value of  $\phi$  applies when both the load combinations of ACI 318-14 5.3 or ACI 318-11 Section 9.2 are used and the requirements of ACI 318-14 17.3.3 or ACI 318-11 D.4.4 (c) for Condition B are met. If the load combinations of ACI 318 Appendix C are used, refer to ACI 318-11 D.4.4 to determine the appropriate value of  $\phi$ .
- The value of  $\phi$  applies when both the load combinations of ACI 318-14 5.3 or ACI 318-11 Section 9.2 are used and the requirements of ACI 318-14 17.3.3 or ACI 318-11 D.4.4 (c) for Condition B are met. If the load combinations of ACI 318-11 Section 9.2 are used and the requirements of ACI 318-11 D.4.4 (c) for Condition A are met, refer to ACI 318-11 D.4.4 to determine the appropriate value of  $\phi$ . If the load combinations of ACI 318 Appendix C are used, refer to ACI 318-11 D.4.5 to determine the appropriate value of  $\phi$ .
- The values of  $f'_c$  used for calculation purposes must not exceed 8,000 psi (55.1 MPa) for uncracked concrete. The value of  $f'_c$  used for calculation purposes must not exceed 2,500 psi (17.2 MPa) for tension resistance in cracked concrete.

\* See p. 12 for an explanation of the load table icons.

# SET-XP® Design Information — Concrete

## SET-XP Shear Strength Design Data for Threaded Rod<sup>1</sup>



Characteristic		Symbol	Units	Nominal Anchor Diameter (in.)							
				3/8	1/2	5/8	3/4	7/8	1	1 1/4	
<b>Steel Strength in Shear</b>											
Threaded Rod	Minimum Shear Stress Area	$A_{se}$	in. <sup>2</sup>	0.078	0.142	0.226	0.334	0.462	0.606	0.969	
	Shear Resistance of Steel — ASTM F1554, Grade 36	$V_{sa}$	lb.	2,260	4,940	7,865	11,625	16,080	21,090	33,720	
	Shear Resistance of Steel — ASTM A193, Grade B7			4,875	10,650	16,950	25,050	34,650	45,450	72,675	
	Shear Resistance of Steel — Type 410 Stainless (ASTM A193, Grade B6)			4,290	9,370	14,910	22,040	30,490	40,000	63,955	
	Shear Resistance of Steel — Type 304 and 316 Stainless (ASTM A193, Grade B8 & B8M)				2,225	4,855	7,730	11,420	15,800	20,725	33,140
	Reduction for Seismic Shear — ASTM F1554, Grade 36	$\alpha_{V_{seis}}^5$	—	0.87	0.78	0.68				0.65	
	Reduction for Seismic Shear — ASTM A193, Grade B7			0.87	0.78	0.68				0.65	
	Reduction for Seismic Shear — Stainless (ASTM A193, Grade B6)			0.69	0.82	0.75		0.83		0.72	
	Reduction for Seismic Shear — Stainless (ASTM A193, Grade B8 & B8M)			0.69	0.82	0.75		0.83		0.72	
	Strength Reduction Factor — Steel Failure	$\phi$	—	0.65 <sup>2</sup>							
<b>Concrete Breakout Strength in Shear</b>											
Outside Diameter of Anchor	$d_o$	in.	0.375	0.5	0.625	0.75	0.875	1	1.25		
Load Bearing Length of Anchor in Shear	$\ell_e$	in.	Min. of $h_{ef}$ and 8 times anchor diameter								
Strength Reduction Factor — Breakout Failure	$\phi$	—	0.70 <sup>3</sup>								
<b>Concrete Pryout Strength in Shear</b>											
Coefficient for Pryout Strength	$k_{cp}$	—	1.0 for $h_{ef} < 2.50"$ ; 2.0 for $h_{ef} \geq 2.50"$								
Strength Reduction Factor — Pryout Failure	$\phi$	—	0.70 <sup>4</sup>								

- The information presented in this table is to be used in conjunction with the design criteria of ACI 318-14 and ACI 318-11.
- The value of  $\phi$  applies when the load combinations of ACI 318-14 5.3 or ACI 318-11 Section 9.2 are used. If the load combinations of ACI 318 Appendix C are used, refer to ACI 318-11 D.4.4 to determine the appropriate value of  $\phi$ .
- The value of  $\phi$  applies when both the load combinations of ACI 318-14 5.3 or ACI 318-11 Section 9.2 are used and the requirements of ACI 318-14 17.3.3 or ACI 318-11 D.4.3 (c) for Condition B are met. If the load combinations of ACI 318-14 5.3 or ACI 318-11 Section 9.2 are used and the requirements of ACI 318-14 17.3.3 or ACI 318-11 D.4.3 (c) for Condition A are met, refer to ACI 318-11 D.4.3 to determine the appropriate value of  $\phi$ . If the load combinations of ACI 318 Appendix C are used, refer to ACI 318-11 D.4.4 to determine the appropriate value of  $\phi$ .
- The value of  $\phi$  applies when both the load combinations of ACI 318-14 5.3 or ACI 318-11 Section 9.2 are used and the requirements of ACI 318-14 5.3 or ACI 318-11 D.4.3 (c) for Condition B are met. If the load combinations of ACI 318 Appendix C are used, refer to ACI 318-11 D.4.4 to determine the appropriate value of  $\phi$ .
- The values of  $V_{sa}$  are applicable for both cracked concrete and uncracked concrete. For anchors installed in regions assigned to Seismic Design Category C, D, E or F,  $V_{sa}$  must be multiplied by  $\alpha_{V_{seis}}$  for the corresponding anchor steel type.

<sup>1</sup> See p. 12 for an explanation of the load table icons.

## SET-XP® Design Information — Concrete

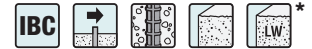
SET-XP Shear Strength Design Data for Rebar<sup>1</sup>

Characteristic	Symbol	Units	Rebar Size							
			#3	#4	#5	#6	#7	#8	#10	
<b>Steel Strength in Shear</b>										
Rebar	Minimum Shear Stress Area	$A_{se}$	in <sup>2</sup>	0.11	0.2	0.31	0.44	0.6	0.79	1.23
	Shear Resistance of Steel — Rebar (ASTM A615 Grade 60)	$V_{sa}$	lb.	4,950	10,800	16,740	23,760	32,400	42,660	66,420
	Reduction for Seismic Shear — Rebar (ASTM A615 Grade 60)	$\alpha_{V_{seis}}^5$	—	0.85	0.88	0.84		0.77		0.59
	Strength Reduction Factor — Steel Failure	$\phi$	—	0.60 <sup>2</sup>						
<b>Concrete Breakout Strength in Shear</b>										
Outside Diameter of Anchor	$d_o$	in.	0.375	0.5	0.625	0.75	0.875	1	1.25	
Load-Bearing Length of Anchor in Shear	$\ell_e$	in.	Min. of $h_{ef}$ and 8 times anchor diameter							
Strength Reduction Factor — Breakout Failure	$\phi$	—	0.70 <sup>3</sup>							
<b>Concrete Pryout Strength in Shear</b>										
Coefficient for Pryout Strength	$k_{cp}$	—	1.0 for $h_{ef} < 2.50"$ ; 2.0 for $h_{ef} \geq 2.50"$							
Strength Reduction Factor — Pryout Failure	$\phi$	—	0.70 <sup>4</sup>							

- The information presented in this table is to be used in conjunction with the design criteria of ACI 318-14 or ACI 318-11.
- The value of  $\phi$  applies when the load combinations of ACI 318-14 5.3 or ACI 318-11 Section 9.2 are used. If the load combinations of ACI 318 Appendix C are used, refer to ACI 318-11 D.4.4 to determine the appropriate value of  $\phi$ .
- The value of  $\phi$  applies when both the load combinations of ACI 318-14 5.3 or ACI 318-11 Section 9.2 are used and the requirements of ACI 318-14 17.3.3 or ACI 318-11 D.4.3 (c) for Condition B are met. If the load combinations of ACI 318-14 5.3 or ACI 318-11 Section 9.2 are used and the requirements of ACI 318-14 17.3.3 or ACI 318-11 D.4.3 (c) for Condition A are met, refer to ACI 318-11 D.4.3 to determine the appropriate value of  $\phi$ . If the load combinations of ACI 318 Appendix C are used, refer to ACI 318-11 D.4.4 to determine the appropriate value of  $\phi$ .
- The value of  $\phi$  applies when both the load combinations of ACI 318-14 5.3 or ACI 318-11 Section 9.2 are used and the requirements of ACI 318-14 5.3 or ACI 318-11 D.4.3 (c) for Condition B are met. If the load combinations of ACI 318 Appendix C are used, refer to ACI 318-11 D.4.4 to determine the appropriate value of  $\phi$ .
- The values of  $V_{sa}$  are applicable for both cracked concrete and uncracked concrete. For anchors installed in regions assigned to Seismic Design Category C, D, E or F,  $V_{sa}$  must be multiplied by  $\alpha_{V_{seis}}$ .

For additional load tables, visit [strongtie.com/setxp](http://strongtie.com/setxp).



## Anchor Designer™ Software for ACI 318, ETAG and CSA

Simpson Strong-Tie® Anchor Designer software accurately analyzes existing design or suggests anchor solutions based on user-defined design elements in cracked and uncracked concrete conditions.

<sup>1</sup> See p. 12 for an explanation of the load table icons.

# SET-XP® Design Information — Concrete

## SET-XP Development Length for Rebar Dowels

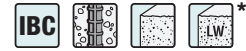

Rebar Size	Drill Bit Diameter (in.)	Clear Cover in. (mm)	Development Length, in. (mm)				
			$f'_c = 2,500$ psi (17.2 MPa) Concrete	$f'_c = 3,000$ psi (20.7 MPa) Concrete	$f'_c = 4,000$ psi (27.6 MPa) Concrete	$f'_c = 6,000$ psi (41.4 MPa) Concrete	$f'_c = 8,000$ psi (55.2 MPa) Concrete
#3 (9.5)	1/2	1 1/2 (38)	12 (305)	12 (305)	12 (305)	12 (305)	12 (305)
#4 (12.7)	5/8	1 1/2 (38)	14.4 (366)	14 (356)	12 (305)	12 (305)	12 (305)
#5 (15.9)	3/4	1 1/2 (38)	18 (457)	17 (432)	14.2 (361)	12 (305)	12 (305)
#6 (19.1)	7/8	1 1/2 (38)	21.6 (549)	20 (508)	17.1 (434)	14 (356)	13 (330)
#7 (22.2)	1	3 (76)	31.5 (800)	29 (737)	25 (635)	21 (533)	18 (457)
#8 (25.4)	1 1/8	3 (76)	36 (914)	33 (838)	28.5 (724)	24 (610)	21 (533)
#9 (28.7)	1 3/8	3 (76)	40.5 (1,029)	38 (965)	32 (813)	27 (686)	23 (584)
#10 (32.3)	1 3/8	3 (76)	45 (1,143)	42 (1,067)	35.6 (904)	30 (762)	26 (660)
#11 (35.8)	1 3/4	3 (76)	51 (1,295)	47 (1,194)	41 (1,041)	33 (838)	29 (737)

1. Tabulated development lengths are for static, wind and seismic load cases in Seismic Design Category A and B. Development lengths in SDC C through F must comply with ACI 318-14 Chapter 18 or ACI 318-11 Chapter 12, as applicable. The value of  $f'_c$  used to calculate development lengths shall not exceed 2,500 psi in SDC C through F.
2. Rebar is assumed to be ASTM A615 Grade 60 or A706 ( $f_y = 60,000$  psi). For rebar with a higher yield strength, multiply tabulated values by  $f_y / 60,000$  psi.
3. Concrete is assumed to be normal-weight concrete. For lightweight concrete, multiply tabulated values by 1.33.
4. Tabulated values assume bottom cover of less than 12" cast below rebars ( $\Psi_1 = 1.0$ ).
5. Uncoated rebar must be used.
6. The value of  $K_{tr}$  is assumed to be 0. Refer to ACI 318-14 Section 25.4.2.3 or ACI 318 Section 12.2.3.

## Rebar Development Length Calculator

Rebar Development Length Calculator is a web application that supports the design of post-installed rebar in concrete applications by calculating the necessary tension and compression development lengths required in accordance with ACI 318-18 / ACI 318-14.

\* See p. 12 for an explanation of the load table icons.

# SET-XP® Design Information — Masonry

SET-XP Allowable Tension and Shear Loads for Threaded Rod and Rebar in the Face of Fully Grouted CMU Wall Construction<sup>1, 3, 4, 5, 6, 8, 9, 10, 11</sup>

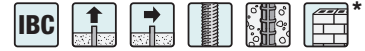

Diameter (in.) or Rebar Size No.	Drill Bit Diameter (in.)	Minimum Embedment <sup>2</sup> (in.)	Allowable Load Based on Bond Strength <sup>7</sup> (lb.)	
			Tension Load	Shear Load
<b>Threaded Rod Installed in the Face of CMU Wall</b>				
3/8	1/2	3 3/8	1,490	1,145
1/2	5/8	4 1/2	1,825	1,350
5/8	3/4	5 5/8	1,895	1,350
3/4	7/8	6 1/2	1,895	1,350
<b>Rebar Installed in the Face of CMU Wall</b>				
#3	1/2	3 3/8	1,395	1,460
#4	5/8	4 1/2	1,835	1,505
#5	3/4	5 5/8	2,185	1,505

1. Allowable load shall be the lesser of the bond values shown in this table and steel values, shown on p. 43.
2. Embedment depth shall be measured from the outside face of masonry wall.
3. Critical and minimum edge distance and spacing shall comply with the information on p. 38. Figure 2 on p. 38 illustrates critical and minimum edge and end distances.
4. Minimum allowable nominal width of CMU wall shall be 8". No more than one anchor shall be permitted per masonry cell.
5. Anchors shall be permitted to be installed at any location in the face of the fully grouted masonry wall construction (cell, web, bed joint), except anchors shall not be installed within 1 1/2" of the head joint, as show in Figure 2 on p. 38.
6. Tabulated allowable load values are for anchors installed in fully grouted masonry walls.
7. Tabulated allowable loads are based on a safety factor of 5.0 .
8. Tabulated allowable load values shall be adjusted for increased base material temperatures in accordance with Figure 1 below, as applicable.
9. Threaded rod and rebar installed in fully grouted masonry walls are permitted to resist dead, live, seismic and wind loads.
10. Threaded rod shall meet or exceed the tensile strength of ASTM F1554, Grade 36 steel, which is 58,000 psi.
11. For installations exposed to severe, moderate or negligible exterior weathering conditions, as defined in Figure 1 of ASTM C62, allowable tension loads shall be multiplied by 0.80.

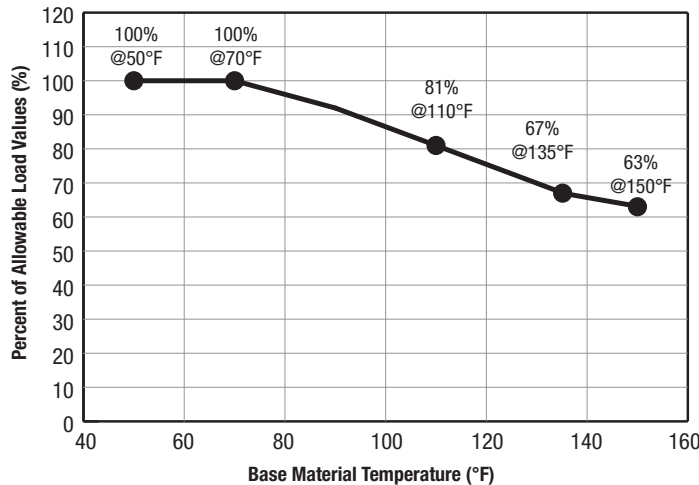
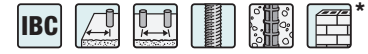

**Figure 1.** Load Capacity Based on In-Service Temperature for SET-XP® Epoxy Adhesive in the Face of Fully Grouted CMU Wall Construction

\* See p. 12 for an explanation of the load table icons.

# SET-XP® Design Information — Masonry

SET-XP Edge Distance and Spacing Requirements and Allowable Load Reduction Factors — Threaded Rod and Rebar in the Face of Fully Grouted CMU Wall Construction<sup>7</sup>



Rod Dia. (in.) or Rebar Size No.	Minimum Embed. Depth (in.)	Edge or End Distance <sup>1,8</sup>						Spacing <sup>2,9</sup>				
		Critical (Full Anchor Capacity) <sup>3</sup>		Minimum (Reduced Anchor Capacity) <sup>4</sup>				Critical (Full Anchor Capacity) <sup>5</sup>		Minimum (Reduced Anchor Capacity) <sup>6</sup>		
		Critical Edge or End Distance, $C_{cr}$ (in.)	Allowable Load Reduction Factor	Minimum Edge or End Distance, $C_{min}$ (in.)	Allowable Load Reduction Factor		Critical Spacing, $S_{cr}$ (in.)	Allowable Load Reduction Factor	Minimum Spacing, $S_{min}$ (in.)	Allowable Load Reduction Factor		
		Load Direction		Load Direction				Load Direction		Load Direction		
		Tension or Shear	Tension or Shear	Tension or Shear	Tension	Shear <sup>10</sup>		Tension or Shear	Tension or Shear	Tension or Shear	Tension	Shear
					Perp.	Para.						
¾	3¾	12	1.00	4	0.91	0.72	0.94	8	1.00	4	1.00	1.00
½	4½	12	1.00	4	1.00	0.58	0.87	8	1.00	4	0.82	1.00
⅝	5⅝	12	1.00	4	1.00	0.48	0.87	8	1.00	4	0.82	1.00
¾	6½	12	1.00	4	1.00	0.44	0.85	8	1.00	4	0.82	1.00
#3	3¾	12	1.00	4	0.96	0.62	0.84	8	1.00	4	0.87	0.91
#4	4½	12	1.00	4	0.88	0.54	0.82	8	1.00	4	0.87	0.91
#5	5⅝	12	1.00	4	0.88	0.43	0.82	8	1.00	4	0.87	1.00

- Edge distance ( $C_{cr}$  or  $C_{min}$ ) is the distance measured from anchor centerline to edge or end of CMU masonry wall. Refer to Figure 2 below for an illustration showing critical and minimum edge and end distances.
- Anchor spacing ( $S_{cr}$  or  $S_{min}$ ) is the distance measured from centerline to centerline of two anchors.
- Critical edge distance,  $C_{cr}$ , is the least edge distance at which tabulated allowable load of an anchor is achieved where a load reduction factor equals 1.0 (no load reduction).
- Minimum edge distance,  $C_{min}$ , is the least edge distance where an anchor has an allowable load capacity which shall be determined by multiplying the allowable loads assigned to anchors installed at critical edge distance,  $C_{cr}$ , by the load reduction factors shown above.
- Critical spacing,  $S_{cr}$ , is the least anchor spacing at which tabulated allowable load of an anchor is achieved such that anchor performance is not influenced by adjacent anchors.
- Minimum spacing,  $S_{min}$ , is the least spacing where an anchors has an allowable load capacity, which shall be determined by multiplying the allowable loads assigned to anchors installed at critical spacing distance,  $S_{cr}$ , by the load reduction factors shown above.
- Reduction factors are cumulative. Multiple reduction factors for more than one spacing or edge or end distance shall be calculated separately and multiplied.
- Load reduction factor for anchors loaded in tension or shear with edge distances between critical and minimum shall be obtained by linear interpolation.
- Load reduction factor for anchors loaded in tension with spacing between critical and minimum shall be obtained by linear interpolation.
- Perpendicular shear loads act towards the edge or end. Parallel shear loads act parallel to the edge or end (see Figure 5 on p. 40). Perpendicular and parallel shear load reduction factors are cumulative when the anchor is located between the critical minimum edge and end distance.

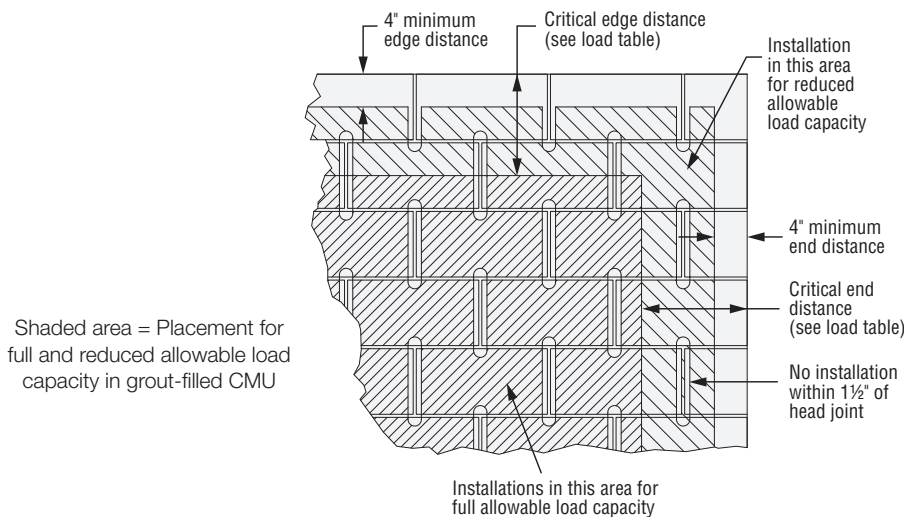
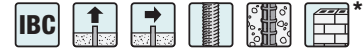

**Figure 2.** Allowable Anchor Locations for Full and Reduced Load Capacity When Installation Is in the Face of Fully Grouted CMU Masonry Wall Construction

\* See p. 12 for an explanation of the load table icons.

# SET-XP® Design Information — Masonry

SET-XP Allowable Tension and Shear Loads for Threaded Rod and Rebar in the Top of Fully Grouted CMU Wall Construction<sup>1, 2, 4, 5, 6, 7, 9, 10, 11, 12</sup>



Diameter (in.) or Rebar Size No.	Drill Bit Diameter (in.)	Minimum Embedment <sup>3</sup> (in.)	Allowable Load Based on Bond Strength <sup>7, 8</sup> (lb.)		
			Tension Load	Shear Perp.	Shear Parallel
<b>Threaded Rod Installed in the Top of CMU Wall</b>					
1/2	5/8	4 1/2	1,485	590	1,050
		12	2,440	665	1,625
5/8	3/4	5 3/4	1,700	565	1,435
		15	2,960	660	1,785
7/8	1	7 3/4	1,610	735	1,370
		21	4,760	670	1,375
<b>Rebar Installed in the Top of CMU Wall</b>					
#4	5/8	4 1/2	1,265	550	865
		12	2,715	465	1,280
#5	3/4	5 3/4	1,345	590	1,140
		15	3,090	590	1,285

1. Allowable load shall be the lesser of the bond values shown in this table and steel values, shown on p. 43.
2. Allowable loads are for installation in the grouted CMU core opening.
3. Embedment depth shall be measured from the horizontal surface of the grouted CMU core opening on top of the masonry wall.
4. Critical and minimum edge distance, end distance and spacing shall comply with the information on pp. 38 and 40. Figures 3A and 3B on p. 40 illustrate critical and minimum edge and end distances.
5. Minimum allowable nominal width of CMU wall shall be 8" (203 mm).
6. Anchors are permitted to be installed in the CMU core opening shown in Figures 3A and 3B on p. 40. Anchors are limited to one installation per CMU core opening.
7. Tabulated allowable load values are for anchors installed in fully grouted masonry walls.
8. Tabulated allowable loads are based on a safety factor of 5.0 .
9. Tabulated allowable load values shall be adjusted for increased base material temperatures in accordance with Figure 1 on p. 37, as applicable.
10. Threaded rod and rebar installed in fully grouted masonry walls with SET-XP® adhesive are permitted to resist dead, live, seismic and wind loads.
11. Threaded rod shall meet or exceed the tensile strength of ASTM F1554, Grade 36 steel, which is 58,000 psi.
12. For installations exposed to severe, moderate or negligible exterior weathering conditions, as defined in Figure 1 of ASTM C62, allowable tension loads shall be multiplied by 0.80.

\* See p. 12 for an explanation of the load table icons.

# SET-XP® Design Information — Masonry

SET-XP Edge and End Distance Requirements and Allowable Load Reduction Factors — Threaded Rod and Rebar in the Top of Fully Grouted CMU Wall Construction<sup>1,4,5</sup>



Rod Dia. (in.) or Rebar Size No.	Minimum Embed. Depth (in.)	Critical (Full Anchor Capacity) <sup>2</sup>			Minimum End (Reduced Anchor Capacity) <sup>3</sup>				Minimum Edge (Reduced Anchor Capacity) <sup>6</sup>			
		Critical Edge, $C_{cr}$ (in.)	Critical End Distance, $C_{cr}$ (in.)	Allowable Load Reduction Factor	Minimum End Distance, $C_{min}$ (in.)	Minimum End Allowable Load Reduction Factor		Minimum Edge, $C_{min}$ (in.)	Allowable Load Reduction Factor			
						Load Direction			Load Direction			
		Tension or Shear	Tension or Shear	Tension or Shear	Tension or Shear	Tension	Shear <sup>6</sup>		Tension or Shear	Tension	Shear <sup>6</sup>	
						Perp.	Parallel			Perp.	Parallel	
1/2	4 1/2	2 3/4	20	1.00	3 19/16	0.88	0.84	0.66	1 3/4	0.83	0.63	0.77
	12	2 3/4	20	1.00	3 19/16	0.64	0.91	0.34	1 3/4	0.95	0.55	0.69
5/8	5 5/8	2 3/4	20	1.00	4 1/4	0.90	1.00	0.50	1 3/4	0.82	0.57	0.71
	15	2 3/4	20	1.00	4 1/4	0.38	0.85	0.29	1 3/4	0.91	0.72	0.73
7/8	7 7/8	2 3/4	20	1.00	4 1/4	0.98	0.72	0.57	—	—	—	—
	21	2 3/4	20	1.00	4 1/4	0.63	0.96	0.64	—	—	—	—
#4	4 1/2	2 3/4	20	1.00	4 1/4	0.96	0.90	0.76	—	—	—	—
	12	2 3/4	20	1.00	4 1/4	0.58	1.00	0.46	—	—	—	—
#5	5 5/8	2 3/4	20	1.00	4 1/4	1.00	0.86	0.60	—	—	—	—
	15	2 3/4	20	1.00	4 1/4	0.41	0.76	0.49	—	—	—	—

- Edge and end distances ( $C_{cr}$  or  $C_{min}$ ) are the distances measured from anchor centerline to edge or end of CMU masonry wall. Refer to Figures 3A and 3B below for illustrations showing critical and minimum edge and end distances.
- Critical edge and end distances,  $C_{cr}$ , are the least edge distances at which tabulated allowable load of an anchor is achieved where a load reduction factor equals 1.0 (no load reduction).
- Minimum edge and end distances,  $C_{min}$ , are the least edge distances where an anchor has an allowable load capacity, which shall be determined by multiplying the allowable loads assigned to anchors installed at critical edge distance,  $C_{cr}$ , by the load reduction factors shown above.
- Reduction factors are cumulative. Multiple reduction factors for more than one spacing or edge or end distance shall be calculated separately and multiplied.
- Load reduction factor for anchors loaded in tension or shear with edge distances between critical and minimum shall be obtained by linear interpolation.
- Perpendicular shear loads act towards the edge or end. Parallel shear loads act parallel to the edge or end (see Figure 5 below). Perpendicular and parallel shear load reduction factors are cumulative when the anchor is located between the critical minimum edge and end distance.

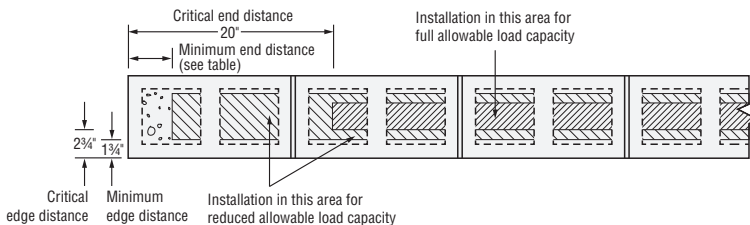

**Figure 3A.** Allowable Anchor Locations of 1/2" - and 5/8" - Diameter Threaded Rod for Full and Reduced Load Capacity When Installation Is in the Top of Fully Grouted CMU Masonry Wall Construction

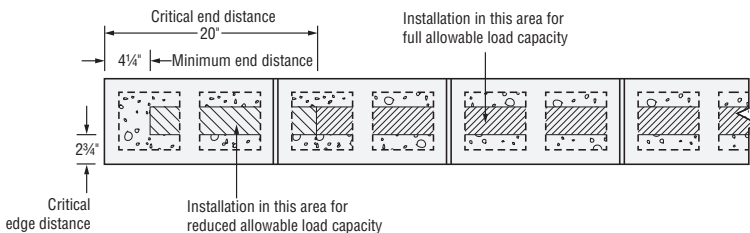

**Figure 3B.** Allowable Anchor Locations of 7/8" - Diameter Threaded Rod and #4 and #5 Rebar for Full and Reduced Load Capacity When Installation Is in the Top of Fully Grouted CMU Masonry Wall Construction

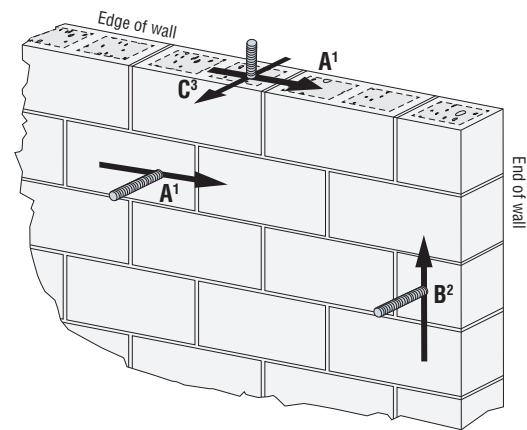

- Direction of shear load A is parallel to edge of wall and perpendicular to end of wall.
- Direction of shear load B is parallel to end of wall and perpendicular to edge of wall.
- Direction of shear load C is perpendicular to edge of wall.

**Figure 5.** Direction of Shear Load in Relation to Edge and End of Wall

\* See p. 12 for an explanation of the load table icons.



# SET-XP® Design Information — Masonry

## SET-XP Spacing Distance Requirements and Allowable Load Reduction Factors — Threaded Rod and Rebar in the Top of Fully Grouted CMU Wall Construction<sup>1,4,5</sup>



Rod Dia. (in.) or Rebar Size No.	Minimum Embed. Depth (in.)	Critical Spacing (Full Anchor Capacity) <sup>2</sup>		Minimum Spacing (Reduced Anchor Capacity) <sup>3</sup>		
		Critical Spacing, $S_{cr}$ (in.)	Allowable Load Reduction Factor	Minimum Spacing, $S_{cr}$ (in.)	Allowable Load Reduction Factor	
		Load Direction		Load Direction		
		Tension or Shear	Tension or Shear	Tension or Shear	Tension	Shear
½	4½	18	1.00	8	0.80	0.92
	12	48	1.00	8	0.63	0.98
⅝	5⅝	22.5	1.00	8	0.86	1.00
	15	60	1.00	8	0.56	1.00
¾	7⅞	31.5	1.00	8	0.84	0.82
	21	84	1.00	8	0.51	0.98
#4	4½	18	1.00	8	0.97	0.93
	12	48	1.00	8	0.75	1.00
#5	5⅝	22.5	1.00	8	1.00	1.00
	15	60	1.00	8	0.82	1.00

- Anchor spacing ( $S_{cr}$  or  $S_{min}$ ) is the distance measured from centerline to centerline of two anchors.
- Critical spacing,  $S_{cr}$ , is the least anchor spacing at which tabulated allowable load of an anchor is achieved such that anchor performance is not influenced by adjacent anchors.
- Minimum spacing,  $S_{min}$ , is the least spacing where an anchor has an allowable load capacity, which shall be determined by multiplying the allowable loads assigned to anchors installed at critical spacing distance,  $S_{cr}$ , by the load reduction factors shown above.
- Reduction factors are cumulative. Multiple reduction factors for more than one spacing or edge or end distance shall be calculated separately and multiplied.
- Load reduction factor for anchors loaded in tension or shear with spacing critical and minimum shall be obtained by linear interpolation.

## SET-XP Allowable Tension and Shear Loads — Threaded Rod in the Face of Hollow CMU Wall Construction<sup>1,3,4,5,6,8,9,10,11</sup>



Diameter (in.)	Drill Bit Diameter (in.)	Minimum Embed. <sup>2</sup> (in.)	Allowable Load Based on Bond Strength <sup>7</sup> (lb.)	
			Tension	Shear
⅜	⅜	1¼	215	385
½	¾	1¼	220	410
⅝	⅞	1¼	225	435

- Allowable load shall be the lesser of bond values shown in this table and steel values shown on p. 43.
- Embedment depth is considered the minimum wall thickness of 8" x 8" x 16" ASTM C90 concrete masonry blocks, and is measured from the outside to the inside face of the block wall. The minimum length Opti-Mesh plastic screen tube for use in hollow CMU is 3½".
- Critical and minimum edge distance and spacing shall comply with the information provided on p. 42. Figure 4 on p. 42 illustrates critical and minimum edge and end distances.
- Anchors are permitted to be installed in the face shell of hollow masonry wall construction as shown in Figure 4.
- Anchors are limited to one or two anchors per masonry cell and must comply with the spacing and edge distance requirements provided.
- Tabulated load values are for anchors installed in hollow masonry walls.
- Tabulated allowable loads are based on a safety factor of 5.0.
- Tabulated allowable load values shall be adjusted for increased base material temperatures in accordance with Figure 1 on p. 37, as applicable.
- Threaded rods installed in hollow masonry walls with SET-XP® adhesive are permitted to resist dead, live load and wind load applications.
- Threaded rods must meet or exceed the tensile strength of ASTM F1554, Grade 36, which is 58,000 psi.
- For installations exposed to severe, moderate or negligible exterior weathering conditions, as defined in Figure 1 of ASTM C62, allowable tension loads must be multiplied by 0.80.
- Screen tubes are required and available on p. 71.

\* See p. 12 for an explanation of the load table icons.

# SET-XP® Design Information — Masonry

SET-XP Edge, End and Spacing Distance Requirements and Allowable Load Reduction Factors — Threaded Rod in the Face of Hollow CMU Wall Construction<sup>7</sup>



Rod Diameter (in.)	Edge or End Distance <sup>1,8</sup>					Spacing <sup>2,9</sup>				
	Critical (Full Anchor Capacity) <sup>3</sup>		Minimum (Reduced Anchor Capacity) <sup>4</sup>			Critical (Full Anchor Capacity) <sup>5</sup>		Minimum (Reduced Anchor Capacity) <sup>6</sup>		
	Critical Edge or End Distance, $C_{cr}$ (in.)	Allowable Load Reduction Factor	Minimum Edge or End Distance, $C_{min}$ (in.)	Allowable Load Reduction Factor		Critical Spacing, $S_{cr}$ (in.)	Allowable Load Reduction Factor	Minimum Spacing, $S_{min}$ (in.)	Allowable Load Reduction Factor	
	Load Direction		Load Direction			Load Direction		Load Direction		
	Tension or Shear	Tension or Shear	Tension or Shear	Tension	Shear <sup>10</sup>	Tension or Shear	Tension or Shear	Tension or Shear	Tension	Shear
3/8	12	1.00	4	1.00	0.74	8	1.00	4	0.82	0.73
1/2	12	1.00	4	0.96	0.69	8	1.00	4	0.79	0.73
5/8	12	1.00	4	0.96	0.55	8	1.00	4	0.75	0.73

- Edge and end distances ( $C_{cr}$  or  $C_{min}$ ) are the distances measured from anchor centerline to edge or end of CMU masonry wall. Refer to Figure 4 below for an illustration showing critical and minimum edge and end distances.
- Anchor spacing ( $S_{cr}$  or  $S_{min}$ ) is the distance measured from centerline to centerline of two anchors.
- Critical edge and end distances,  $C_{cr}$ , are the least edge distances at which tabulated allowable load of an anchor is achieved where a load reduction factor equals 1.0 (no load reduction).
- Minimum edge and end distances,  $C_{min}$ , are the least edge distances where an anchor has an allowable load capacity which shall be determined by multiplying the allowable loads assigned to anchors installed at critical edge distance,  $C_{cr}$ , by the load reduction factors shown above.
- Critical spacing,  $S_{cr}$ , is the least anchor spacing at which tabulated allowable load of an anchor is achieved such that anchor performance is not influenced by adjacent anchors.
- Minimum spacing,  $S_{min}$ , is the least spacing where an anchors has an allowable load capacity, which shall be determined by multiplying the allowable loads assigned to anchors installed at critical spacing distance,  $S_{cr}$ , by the load reduction factors shown above.
- Reduction factors are cumulative. Multiple reduction factors for more than one spacing or edge or end distance shall be calculated separately and multiplied.
- Load reduction factor for anchors loaded in tension or shear with edge distances between critical and minimum shall be obtained by linear interpolation.
- Load reduction factor for anchors loaded in tension with spacing between critical and minimum shall be obtained by linear interpolation.
- Perpendicular shear loads act toward the edge or end. Parallel shear loads act parallel to the edge or end (see Figure 5 on p. 40). Perpendicular and parallel shear load reduction factors are cumulative when the anchor is located between the critical minimum edge and end distance.
- Screen tubes are required and available on p. 71.

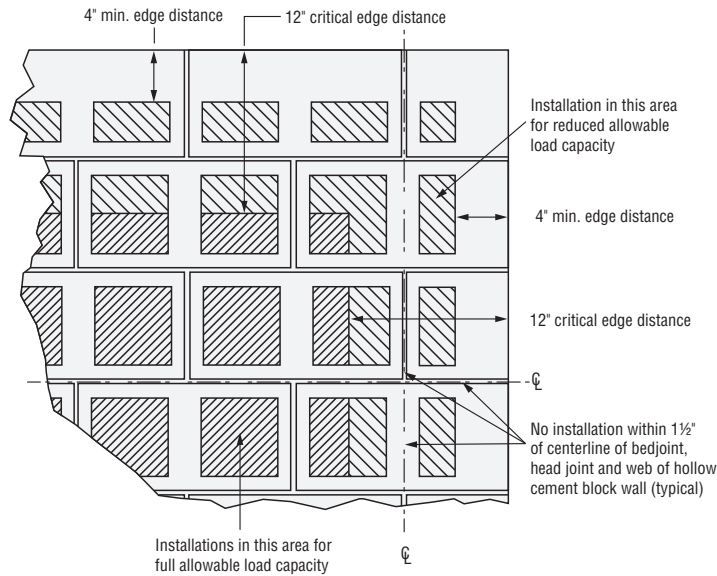

**Figure 4.** Allowable Anchor Locations for Full and Reduced Load Capacity When Installation Is in the Face of Hollow CMU Masonry Wall Construction

\* See p. 12 for an explanation of the load table icons.

# SET-XP® Design Information — Steel

## SET-XP Allowable Tension and Shear Loads — Threaded Rod Based on Steel Strength<sup>1</sup>



Threaded Rod Diameter (in.)	Tensile Stress Area (in. <sup>2</sup> )	Tension Load Based on Steel Strength <sup>2</sup> (lb.)				Shear Load Based on Steel Strength <sup>3</sup> (lb.)			
		ASTM F1554 Grade 36 <sup>4</sup>	ASTM A193 Grade B7 <sup>6</sup>	Stainless Steel		ASTM F1554 Grade 36 <sup>4</sup>	ASTM A193 Grade B7 <sup>6</sup>	Stainless Steel	
				ASTM A193 Grade B6 <sup>5</sup>	ASTM A193 Grades B8 and B8M <sup>7</sup>			ASTM A193 Grade B6 <sup>5</sup>	ASTM A193 Grades B8 and B8M <sup>7</sup>
3/8	0.078	1,495	3,220	2,830	1,930	770	1,660	1,460	995
1/2	0.142	2,720	5,860	5,155	3,515	1,400	3,020	2,655	1,810
5/8	0.226	4,325	9,325	8,205	5,595	2,230	4,805	4,225	2,880
3/4	0.334	6,395	13,780	12,125	8,265	3,295	7,100	6,245	4,260
7/8	0.462	8,845	19,055	16,770	11,435	4,555	9,815	8,640	5,890

1. Allowable load shall be the lesser of bond values given on pp. 37, 39 or 41 and steel values in the table above.
2. Allowable Tension Steel Strength is based on the following equation:  $F_t = 0.33 \times F_u \times \text{Tensile Stress Area}$ .
3. Allowable Shear Steel Strength is based on the following equation:  $F_v = 0.17 \times F_u \times \text{Tensile Stress Area}$ .
4. Minimum specified tensile strength ( $F_u = 58,000$  psi) of ASTM F1554, Grade 36 used to calculate allowable steel strength.
5. Minimum specified tensile strength ( $F_u = 110,000$  psi) of ASTM A193, Grade B6 used to calculate allowable steel strength.
6. Minimum specified tensile strength ( $F_u = 125,000$  psi) of ASTM A193, Grade B7 used to calculate allowable steel strength.
7. Minimum specified tensile strength ( $F_u = 75,000$  psi) of ASTM A193, Grades B8 and B8M used to calculate allowable steel strength.

## SET-XP® Allowable Tension and Shear Loads — Deformed Reinforcing Bar Based on Steel Strength<sup>1</sup>



Rebar Size	Tensile Stress Area (in. <sup>2</sup> )	Tension Load (lb.)		Shear Load (lb.)	
		Based on Steel Strength		Based on Steel Strength	
		ASTM A615 Grade 40 <sup>2</sup>	ASTM A615 Grade 60 <sup>3</sup>	ASTM A615 Grade 40 <sup>4,5</sup>	ASTM A615 Grade 60 <sup>4,6</sup>
#3	0.11	2,200	2,640	1,310	1,685
#4	0.20	4,000	4,800	2,380	3,060
#5	0.31	6,200	7,440	3,690	4,745

1. Allowable load shall be the lesser of bond values given on pp. 37, 39 or 41 and steel values in the table above.
2. Allowable Tension Steel Strength is based on AC58 Section 3.3.3 (20,000 psi x tensile stress area) for Grade 40 rebar.
3. Allowable Tension Steel Strength is based on AC58 Section 3.3.3 (24,000 psi x tensile stress area) for Grade 60 rebar.
4. Allowable Shear Steel Strength is based on AC58 Section 3.3.3 ( $F_v = 0.17 \times F_u \times \text{Tensile Stress Area}$ ).
5.  $F_u = 70,000$  psi for Grade 40 rebar.
6.  $F_u = 90,000$  psi for Grade 60 rebar.

\* See p. 12 for an explanation of the load table icons.

## ET-HP® Epoxy Adhesive

ET-HP is a two-component, high-solids, epoxy-based system for use as a non-shrink anchor-grouting material. ET-HP is formulated for anchoring threaded rod and rebar into concrete (cracked and uncracked) and masonry (uncracked).

### Features

- Jobsite versatility — can be specified for dry and damp conditions when in-service temperatures range from -40°F (-40°C) to 150°F (65°C)
- Permissible for use with metric threaded rod and rebar
- Multiple State and DOT approvals

### Product Information

Mix Ratio/Type	1:1 epoxy
Mixed Color	Gray
Base Materials	Concrete — cracked and uncracked Masonry — uncracked Unreinforced Masonry (URM) — uncracked
Base Material Conditions	Dry, water-saturated
Anchor Type	Threaded rod or rebar
Substrate Installation Temperature	50°F (10°C) to 100°F (38°C)
In-Service Temperature Range	-40°F (-40°C) to 150°F (65°C)
Storage Temperature	45°F (7°C) and 90°F (32°C)
Shelf Life	24 months
Volatile Organic Compound (VOC)	3 g/L
Chemical Resistance	See pp. 268–269
Manufactured in the USA using global materials	

### Test Criteria

ET-HP has been tested in accordance with ICC-ES AC308, AC58, AC60, ACI 355.4 and applicable ASTM test methods.

### Code Reports, Standards and Compliance

Concrete — ICC-ES ESR-3372 (including City of LA); FL15730.  
Masonry — IAPMO UES ER-241 (including Florida Supplement); FL16230.  
Unreinforced Masonry (URM) — ICC-ES ESR-3638; City of L.A. RR25120.  
ASTM C881 and AASHTO M235 — Types I/IV, II/V, Class B and C, Grade 3

### Installation Instructions

Installation instructions are located at the following locations: pp. 64–67; product packaging; or [strongtie.com](http://strongtie.com).

- Hole cleaning brushes are located on p. 68.

### ET-HP Package Systems

Model No.	Capacity (ounces)	Package Type	Carton Quantity	Dispensing Tools	Mixing Nozzle
ET-HP22-N <sup>4</sup>	22	Side-by-side	10	EDT22S, EDTA22P, EDTA22CKT	EMN22I

1. Cartridge estimation guidelines are available at [strongtie.com/softwareandwebapplications/category](http://strongtie.com/softwareandwebapplications/category).
2. Detailed information on dispensing tools, mixing nozzles and other adhesive accessories is available at [strongtie.com](http://strongtie.com).
3. Use only Simpson Strong-Tie® mixing nozzles in accordance with Simpson Strong-Tie instructions. Modification or improper use of mixing nozzle may impair ET-HP adhesive performance.
4. One EMN22I mixing nozzle and one nozzle extension are supplied with each cartridge.



ET-HP Adhesive

# ET-HP® Epoxy Adhesive

## ET-HP Cure Schedule

Base Material Temperature		Gel Time (minutes)	Cure Time <sup>1</sup> (hrs.)
°F	°C		
50	10	45	72
60	16	30	24
80	27	20	24
100	38	15	24

1. For water-saturated concrete, the cure times must be doubled.

## ET-HP Typical Properties

Property		Class B	Class C	Test Method
		(40°–60°F)	(>60°F)	
Consistency		Non-sag	Non-sag	ASTM C881
Bond Strength, Slant Shear	Hardened to Hardened Concrete, 2-Day Cure <sup>1</sup>	1,300 psi	2,300 psi	ASTM C882
	Hardened to Hardened Concrete, 14-Day Cure <sup>1</sup>	1,750 psi	2,400 psi	
	Fresh to Hardened Concrete, 14-Day Cure <sup>2</sup>	2,800 psi	2,800 psi	
Compressive Yield Strength, 7-Day Cure <sup>2</sup>		11,800 psi	16,300 psi	ASTM D695
Compressive Modulus, 7-Day Cure <sup>2</sup>		453,000 psi	595,000 psi	ASTM D695
Heat Deflection Temperature, 7-Day Cure <sup>2</sup>		133°F (56°C)		ASTM D648
Glass Transition Temperature, 7-Day Cure <sup>2</sup>		121°F (49°C)		ASTM E1356
Decomposition Temperature, 24-Hour Cure <sup>2</sup>		500°F (260°C)		ASTM E2550
Water Absorption, 24-Hours, 7-Day Cure <sup>2</sup>		0.34%		ASTM D570
Shore D Hardness, 24-Hour Cure <sup>2</sup>		86		ASTM D2240
Linear Coefficient of Shrinkage, 7-Day Cure <sup>2</sup>		0.001 in./in.		ASTM D2566
Coefficient of Thermal Expansion <sup>2</sup>		2.1 x 10 <sup>-5</sup> in./in.°F		ASTM C531

1. Material and curing conditions: Class B at 40° ± 2°F, Class C at 60° ± 2°F.

2. Material and curing conditions: 73° ± 2°F.

## ET-HP Installation Information and Additional Data for Threaded Rod and Rebar<sup>1</sup>



Characteristic	Symbol	Units	Nominal Anchor Diameter (in.) / Rebar Size						
			3/8 / #3	1/2 / #4	5/8 / #5	3/4 / #6	7/8 / #7	1 / #8	1 1/4 / #10
<b>Installation Information</b>									
Drill Bit Diameter	$d_{hole}$	in.	1/2	5/8	3/4	7/8	1	1 1/8	1 3/8
Maximum Tightening Torque	$T_{inst}$	ft.-lb.	15	25	40	50	60	80	150
Permitted Embedment Depth Range	Minimum	$h_{ef}$	2 3/8	2 3/4	3 1/8	3 1/2	3 3/4	4	5
	Maximum	$h_{ef}$	4 1/2	6	7 1/2	9	10 1/2	12	15
Minimum Concrete Thickness	$h_{min}$	in.	$h_{ef} + 5d_{hole}$						
Critical Edge Distance <sup>2</sup>	$c_{ac}$	in.	See footnote 2						
Minimum Edge Distance	$c_{min}$	in.	1 3/4						2 3/4
Minimum Anchor Spacing	$s_{min}$	in.	3						6

1. The information presented in this table is to be used in conjunction with the design criteria of ACI 318-14 and ACI 318-11.

2.  $c_{ac} = h_{ef}(\tau_{k,uncr}/1160)^{0.4} \times [3.1 - 0.7(h/h_{ef})]$ , where:

$$[h/h_{ef}] \leq 2.4$$

$\tau_{k,uncr}$  = the characteristic bond strength in uncracked concrete, given in the tables that follow  $\leq k_{uncr} ((h_{ef} \times f'_c)^{0.5} / (\pi \times d_a))$

$h$  = the member thickness (inches)

$h_{ef}$  = the embedment depth (inches)

\* See p. 12 for an explanation of the load table icons.

# ET-HP® Design Information — Concrete

ET-HP Tension Strength Design Data for Threaded Rod<sup>1</sup>



Characteristic		Symbol	Units	Nominal Anchor Diameter (in.)							
				3/8	1/2	5/8	3/4	7/8	1	1 1/4	
<b>Steel Strength in Tension</b>											
Threaded Rod	Minimum Tensile Stress Area	$A_{se}$	in. <sup>2</sup>	0.078	0.142	0.226	0.334	0.462	0.606	0.969	
	Tension Resistance of Steel — ASTM F1554, Grade 36	$N_{sa}$	lb.	4,525	8,235	13,110	19,370	26,795	35,150	56,200	
	Tension Resistance of Steel — ASTM A193, Grade B7			9,750	17,750	28,250	41,750	57,750	75,750	121,125	
	Tension Resistance of Steel — Type 410 Stainless (ASTM A193, Grade B6)			8,580	15,620	24,860	36,740	50,820	66,660	106,590	
	Tension Resistance of Steel — Type 304 and 316 Stainless (ASTM A193, Grade B8 & B8M)			4,445	8,095	12,880	19,040	26,335	34,540	55,235	
	Strength Reduction Factor — Steel Failure			$\phi$	—	0.75 <sup>6</sup>					
<b>Concrete Breakout Strength in Tension (2,500 psi ≤ f'<sub>c</sub> ≤ 8,000 psi)<sup>12</sup></b>											
Effectiveness Factor — Uncracked Concrete		$k_{uncr}$	—	24							
Effectiveness Factor — Cracked Concrete		$k_{cr}$	—	17							
Strength Reduction Factor — Breakout Failure		$\phi$	—	0.65 <sup>8</sup>							
<b>Bond Strength in Tension (2,500 psi ≤ f'<sub>c</sub> ≤ 8,000 psi)<sup>12</sup></b>											
Uncracked Concrete <sup>2,3,4</sup>	Characteristic Bond Strength <sup>5,13</sup>		$\tau_{k,uncr}$	psi	390	380	370	360	350	335	315
	Permitted Embedment Depth Range	Minimum	$h_{ef}$	in.	2 3/8	2 3/4	3 1/8	3 1/2	3 3/4	4	5
		Maximum			4 1/2	6	7 1/2	9	10 1/2	12	15
Cracked Concrete <sup>2,3,4</sup>	Characteristic Bond Strength <sup>5,9,10,11,12,13</sup>		$\tau_{k,cr}$	psi	160	200	160	205	190	165	140
	Permitted Embedment Depth Range	Minimum	$h_{ef}$	in.	3	3	3 1/8	3 1/2	3 3/4	4	5
		Maximum			4 1/2	6	7 1/2	9	10 1/2	12	15
<b>Bond Strength in Tension — Bond Strength Reduction Factors for Periodic Special Inspection</b>											
Strength Reduction Factor — Dry Concrete		$\phi_{dry}$	—	0.65 <sup>7</sup>							
Strength Reduction Factor — Water-Saturated Concrete		$\phi_{sat}$	—	0.45 <sup>7</sup>							

- The information presented in this table is to be used in conjunction with the design criteria of ACI 318-14 or ACI 318-11.
- Temperature Range: Maximum short-term temperature of 150°F (66°C). Maximum long-term temperature of 110°F (43°C).
- Short-term concrete temperatures are those that occur over short intervals (diurnal cycling).
- Long-term concrete temperatures are constant temperatures over a significant time period.
- For anchors that only resist wind or seismic loads, bond strengths may be multiplied by 2.70.
- The value of  $\phi$  applies when the load combinations of ACI 318-14 5.3 or ACI 318-11 Section 9.2 are used. If the load combinations of ACI 318 Appendix C are used, refer to ACI 318-11 D.4.4 to determine the appropriate value of  $\phi$ .
- The value of  $\phi$  applies when both the load combinations of ACI 318-14 5.3 or ACI 318-11 Section 9.2 are used and the requirements of ACI 318-14 17.3.3 or ACI 318-11 D.4.4 (c) for Condition B are met. If the load combinations of ACI 318 Appendix C are used, refer to ACI 318-11 D.4.5 to determine the appropriate value of  $\phi$ .
- The value of  $\phi$  applies when both the load combinations of ACI 318-14 5.3 or ACI 318-11 Section 9.2 are used and the requirements of ACI 318-14 17.3.3 or ACI 318-11 D.4.4 (c) for Condition A are met. If the load combinations of ACI 318-14 5.3 or ACI 318-11 Section 9.2 are used and the requirements of ACI 318-11 D.4.4 (c) for Condition B are met, refer to ACI 318-11 D.4.4 to determine the appropriate value of  $\phi$ . If the load combinations of ACI 318 Appendix C are used, refer to ACI 318-11 D.4.5 to determine the appropriate value of  $\phi$ .
- For anchors installed in regions assigned to Seismic Design Category C, D, E or F, the bond strength values for 3/8" and 1 1/4" anchors must be multiplied by  $\alpha_{N,seis} = 0.78$ .
- For anchors installed in regions assigned to Seismic Design Category C, D, E or F, the bond strength values for 1/2", 5/8" and 3/4" anchors must be multiplied by  $\alpha_{N,seis} = 0.85$ .
- For anchors installed in regions assigned to Seismic Design Category C, D, E or F, the bond strength values for 7/8" anchors must be multiplied by  $\alpha_{N,seis} = 0.82$ .
- For anchors installed in regions assigned to Seismic Design Category C, D, E or F, the bond strength values for 1" anchors must be multiplied by  $\alpha_{N,seis} = 0.70$ .

\* See p. 12 for an explanation of the load table icons.

# ET-HP® Design Information — Concrete

## ET-HP Tension Strength Design Data for Rebar<sup>1</sup>



Characteristic		Symbol	Units	Rebar Size							
				#3	#4	#5	#6	#7	#8	#10	
<b>Steel Strength in Tension</b>											
Rebar	Minimum Tensile Stress Area	$A_{se}$	in <sup>2</sup>	0.11	0.2	0.31	0.44	0.6	0.79	1.27	
	Tension Resistance of Steel — Rebar (ASTM A615 Grade 60)	$N_{sa}$	lb.	9,900	18,000	27,900	39,600	54,000	71,100	114,300	
	Strength Reduction Factor — Steel Failure	$\phi$	—	0.65 <sup>6</sup>							
<b>Concrete Breakout Strength in Tension (2,500 psi ≤ f'<sub>c</sub> ≤ 8,000 psi)</b>											
Effectiveness Factor — Uncracked Concrete		$k_{uncr}$	—	24							
Effectiveness Factor — Cracked Concrete		$k_{cr}$	—	17							
Strength Reduction Factor — Breakout Failure		$\phi$	—	0.65 <sup>8</sup>							
<b>Bond Strength in Tension (2,500 psi ≤ f'<sub>c</sub> ≤ 8,000 psi)</b>											
Uncracked Concrete <sup>2,3,4</sup>	Characteristic Bond Strength <sup>5,9</sup>		$\tau_{k,uncr}$	psi	370	360	350	335	325	315	295
	Permitted Embedment Depth Range	Minimum	$h_{ef}$	in.	2 <sup>3</sup> / <sub>8</sub>	2 <sup>3</sup> / <sub>4</sub>	3 <sup>1</sup> / <sub>2</sub>	3 <sup>1</sup> / <sub>2</sub>	3 <sup>3</sup> / <sub>4</sub>	4	5
		Maximum			4 <sup>1</sup> / <sub>2</sub>	6	7 <sup>1</sup> / <sub>2</sub>	9	10 <sup>1</sup> / <sub>2</sub>	12	15
Cracked Concrete <sup>2,3,4</sup>	Characteristic Bond Strength <sup>5,9</sup>		$\tau_{k,cr}$	psi	130	140	155	165	180	190	215
	Permitted Embedment Depth Range	Minimum	$h_{ef}$	in.	3	3	3 <sup>1</sup> / <sub>2</sub>	3 <sup>1</sup> / <sub>2</sub>	3 <sup>3</sup> / <sub>4</sub>	4	5
		Maximum			4 <sup>1</sup> / <sub>2</sub>	6	7 <sup>1</sup> / <sub>2</sub>	9	10 <sup>1</sup> / <sub>2</sub>	12	15
<b>Bond Strength in Tension — Bond Strength Reduction Factors for Periodic and Continuous Special Inspection</b>											
Strength Reduction Factor — Dry Concrete		$\phi_{dry}$	—	0.65 <sup>7</sup>							
Strength Reduction Factor — Water-Saturated Concrete		$\phi_{sat}$	—	0.45 <sup>7</sup>							

- The information presented in this table is to be used in conjunction with the design criteria of ACI 318-14 or ACI 318-11.
- Temperature Range: Maximum short-term temperature of 150°F (66°C). Maximum long-term temperature of 110°F (43°C).
- Short-term concrete temperatures are those that occur over short intervals (diurnal cycling).
- Long-term concrete temperatures are constant temperatures over a significant time period.
- For anchors that only resist wind or seismic loads, bond strengths may be multiplied by 2.70.
- The value of  $\phi$  applies when the load combinations of ACI 318-14 5.3 or ACI 318-11 Section 9.2 are used. If the load combinations of ACI 318 Appendix C are used, refer to ACI 318-11 D.4.4 to determine the appropriate value of  $\phi$ .
- The value of  $\phi$  applies when both the load combinations of ACI 318-14 5.3 or ACI 318-11 Section 9.2 are used and the requirements of ACI 318-14 17.3.3 or ACI 318-11 D.4.4 (c) for Condition B are met. If the load combinations of ACI 318 Appendix C are used, refer to ACI 318-11 D.4.5 to determine the appropriate value of  $\phi$ .
- The value of  $\phi$  applies when both the load combinations of ACI 318-14 5.3 or ACI 318-11 Section 9.2 are used and the requirements of ACI 318-14 17.3.3 or ACI 318-11 D.4.4 (c) for Condition B are met. If the load combinations of ACI 318-14 5.3 or ACI 318-11 Section 9.2 are used and the requirements of ACI 318-11 D.4.4 (c) for Condition A are met, refer to ACI 318-11 D.4.4 to determine the appropriate value of  $\phi$ . If the load combinations of ACI 318 Appendix C are used, refer to ACI 318-11 D.4.5 to determine the appropriate value of  $\phi$ .

\* See p. 12 for an explanation of the load table icons.

# ET-HP® Design Information — Concrete

## ET-HP Shear Strength Design Data for Threaded Rod<sup>1</sup>



Characteristic		Symbol	Units	Nominal Anchor Diameter (in.)						
				3/8	1/2	5/8	3/4	7/8	1	1 1/4
<b>Steel Strength in Shear</b>										
Threaded Rod	Minimum Shear Stress Area	$A_{se}$	in. <sup>2</sup>	0.078	0.142	0.226	0.334	0.462	0.606	0.969
	Shear Resistance of Steel — ASTM F1554, Grade 36	$V_{sa}$	lb.	2,260	4,940	7,865	11,625	16,080	21,090	33,720
	Shear Resistance of Steel — ASTM A193, Grade B7			4,875	10,650	16,950	25,050	34,650	45,450	72,675
	Shear Resistance of Steel — Type 410 Stainless (ASTM A193, Grade B6)			4,290	9,370	14,910	22,040	30,490	40,000	63,955
	Shear Resistance of Steel — Type 304 and 316 Stainless (ASTM A193, Grade B8 & B8M)			2,225	4,855	7,730	11,425	15,800	20,725	33,140
	Reduction for Seismic Shear — ASTM F1554, Grade 36	$\alpha V_{seis}$ <sup>5</sup>	—	0.63		0.85		0.75		
	Reduction for Seismic Shear — ASTM A193, Grade B7			0.63		0.85		0.75		
	Reduction for Seismic Shear — Stainless (ASTM A193, Grade B6)			0.60		0.85		0.75		
	Reduction for Seismic Shear — Stainless (ASTM A193, Grade B8 & B8M)			0.60		0.85		0.75		
	Strength Reduction Factor — Steel Failure	$\phi$	—	0.65 <sup>2</sup>						
<b>Concrete Breakout Strength in Shear</b>										
Outside Diameter of Anchor	$d_o$	in.	0.375	0.5	0.625	0.75	0.875	1	1.25	
Load Bearing Length of Anchor in Shear	$\ell_e$	in.	Min. of $h_{ef}$ and 8 times anchor diameter							
Strength Reduction Factor — Breakout Failure	$\phi$	—	0.70 <sup>3</sup>							
<b>Concrete Pryout Strength in Shear</b>										
Coefficient for Pryout Strength	$k_{cp}$	—	1.0 for $h_{ef} < 2.50"$ ; 2.0 for $h_{ef} \geq 2.50"$							
Strength Reduction Factor — Pryout Failure	$\phi$	—	0.70 <sup>4</sup>							

- The information presented in this table is to be used in conjunction with the design criteria of ACI 318-14 and ACI 318-11.
- The value of  $\phi$  applies when the load combinations of ACI 318-14 5.3 or ACI 318-11 Section 9.2 are used.  
If the load combinations of ACI 318 Appendix C are used, refer to ACI 318-11 D.4.4 to determine the appropriate value of  $\phi$ .
- The value of  $\phi$  applies when both the load combinations of ACI 318-14 5.3 or ACI 318-11 Section 9.2 are used and the requirements of ACI 318-14 17.3.3 and ACI 318-11 D.4.3 (c) for Condition B are met. If the load combinations of ACI 318-14 5.3 or ACI 318-11 Section 9.2 are used and the requirements of ACI 318-14 17.3.3 and ACI 318-11 D.4.3 (c) for Condition A are met, refer to ACI 318-14 17.3.3 and ACI 318-11 D.4.3 to determine the appropriate value of  $\phi$ . If the load combinations of ACI 318 Appendix C are used, refer to ACI 318-14 and ACI 318-11 D.4.4 to determine the appropriate value of  $\phi$ .
- The value of  $\phi$  applies when both the load combinations of ACI 318-14 5.3 or ACI 318-11 Section 9.2 are used and the requirements of ACI 318-14 17.3.3 and ACI 318-11 D.4.3 (c) for Condition B are met. If the load combinations of ACI 318 Appendix C are used, refer to ACI 318-14 and ACI 318-11 D.4.4 to determine the appropriate value of  $\phi$ .
- The values of  $V_{sa}$  are applicable for both cracked concrete and uncracked concrete. For anchors installed in regions assigned to Seismic Design Category C, D, E or F,  $V_{sa}$  must be multiplied by  $\alpha V_{seis}$  for the corresponding anchor steel type.

<sup>5</sup> See p. 12 for an explanation of the load table icons.



# ET-HP® Design Information — Concrete



## ET-HP Shear Strength Design Data for Rebar<sup>1</sup>

Characteristic	Symbol	Units	Rebar Size							
			#3	#4	#5	#6	#7	#8	#10	
<b>Steel Strength in Shear</b>										
Rebar	Minimum Shear Stress Area	$A_{se}$	in. <sup>2</sup>	0.11	0.2	0.31	0.44	0.6	0.79	1.27
	Shear Resistance of Steel — Rebar (ASTM A615 Grade 60)	$V_{sa}$	lb.	4,950	10,800	16,740	23,760	32,400	42,660	68,580
	Reduction for Seismic Shear — Rebar (ASTM A615 Grade 60)	$\alpha_{V_{seis}}$ <sup>5</sup>	—	0.6		0.8			0.75	
	Strength Reduction Factor — Steel Failure	$\phi$	—	0.60 <sup>2</sup>						
<b>Concrete Breakout Strength in Shear</b>										
Outside Diameter of Anchor	$d_o$	in.	0.375	0.5	0.625	0.75	0.875	1	1.25	
Load-Bearing Length of Anchor in Shear	$\ell_e$	in.	Min. of $h_{ef}$ and 8 times anchor diameter							
Strength Reduction Factor — Breakout Failure	$\phi$	—	0.70 <sup>3</sup>							
<b>Concrete Pryout Strength in Shear</b>										
Coefficient for Pryout Strength	$k_{cp}$	—	1.0 for $h_{ef} < 2.50"$ ; 2.0 for $h_{ef} \geq 2.50"$							
Strength Reduction Factor — Pryout Failure	$\phi$	—	0.70 <sup>4</sup>							

- The information presented in this table is to be used in conjunction with the design criteria of ACI 318-14 or ACI 318-11.
- The value of  $\phi$  applies when the load combinations of ACI 318-14 5.3 or ACI 318-11 Section 9.2 are used. If the load combinations of ACI 318 Appendix C are used, refer to ACI 318-11 D.4.4 to determine the appropriate value of  $\phi$ .
- The value of  $\phi$  applies when both the load combinations of ACI 318-14 5.3 or ACI 318-11 Section 9.2 are used and the requirements of ACI 318-14 17.3.3 and ACI 318-11 D.4.3 (c) for Condition B are met. If the load combinations of ACI 318-14 5.3 or ACI 318-11 Section 9.2 are used and the requirements of ACI 318-14 17.3.3 and ACI 318-11 D.4.3 (c) for Condition A are met, refer to ACI 318-14 17.3.3 and ACI 318-11 D.4.3 to determine the appropriate value of  $\phi$ . If the load combinations of ACI 318 Appendix C are used, refer to ACI 318-14 and ACI 318-11 D.4.4 to determine the appropriate value of  $\phi$ .
- The value of  $\phi$  applies when both the load combinations of ACI 318-14 5.3 or ACI 318-11 Section 9.2 are used and the requirements of ACI 318-14 17.3.3 and ACI 318-11 D.4.3 (c) for Condition B are met. If the load combinations of ACI 318 Appendix C are used, refer to ACI 318-14 and ACI 318-11 D.4.4 to determine the appropriate value of  $\phi$ .
- The values of  $V_{sa}$  are applicable for both cracked concrete and uncracked concrete. For anchors installed in regions assigned to Seismic Design Category C, D, E or F,  $V_{sa}$  must be multiplied by  $\alpha_{V_{seis}}$ .

For additional load tables, visit [strongtie.com](http://strongtie.com).



## Anchor Designer™ Software for ACI 318, ETAG and CSA

Simpson Strong-Tie® Anchor Designer software accurately analyzes existing design or suggests anchor solutions based on user-defined design elements in cracked and uncracked concrete conditions.

\* See p. 12 for an explanation of the load table icons.

# ET-HP® Design Information — Masonry

ET-HP Allowable Tension and Shear Loads for Threaded Rod and Rebar in the Face of Fully Grouted CMU Wall Construction<sup>1, 3, 4, 5, 6, 8, 9, 10, 11, 12</sup>

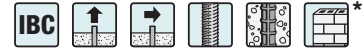

Diameter (in.) or Rebar Size No.	Drill Bit Diameter (in.)	Minimum Embedment <sup>2</sup> (in.)	Allowable Load Based on Bond Strength <sup>7</sup> (lb.)	
			Tension Load	Shear Load
<b>Threaded Rod Installed in the Face of CMU Wall</b>				
3/8	1/2	3 3/8	1,425	845
1/2	5/8	4 1/2	1,425	1,470
5/8	3/4	5 5/8	1,560	1,835
3/4	7/8	6 3/4	1,560	2,050
<b>Rebar Installed in the Face of CMU Wall</b>				
#3	1/2	3 3/8	1,275	1,335
#4	5/8	4 1/2	1,435	1,355
#5	3/4	5 5/8	1,550	1,355

1. Allowable load shall be the lesser of the bond values shown in this table and steel values, shown on p. 52.
2. Embedment depth shall be measured from the outside face of masonry wall.
3. Critical and minimum edge distance and spacing shall comply with the information on p. 51. Figure 2 on p. 51 illustrates critical and minimum edge and end distances.
4. Minimum allowable nominal width of CMU wall shall be 8". The minimum allowable member thickness shall be no less than 1 1/2 times the actual anchor embedment.
5. No more than one anchor shall be permitted per masonry cell.
6. Anchors shall be permitted to be installed at any location in the face of the fully grouted masonry wall construction (cell, web, bed joint), except anchors shall not be installed within 1 1/2" of the head joint, as show in Figure 2 on p. 51.
7. Tabulated allowable load values are for anchors installed in fully grouted masonry walls.
8. Tabulated allowable loads are based on a safety factor of 5.0.
9. Tabulated allowable load values shall be adjusted for increased base material temperatures in accordance with Figure 1 below, as applicable.
10. Threaded rod and rebar installed in fully grouted masonry walls with ET-HP® are permitted to resist dead, live, seismic and wind loads.
11. Threaded rod shall meet or exceed the tensile strength of ASTM F1554, Grade 36 steel, which is 58,000 psi.
12. For installations exposed to severe, moderate or negligible exterior weathering conditions, as defined in Figure 1 of ASTM C62, allowable tension loads shall be multiplied by 0.80.

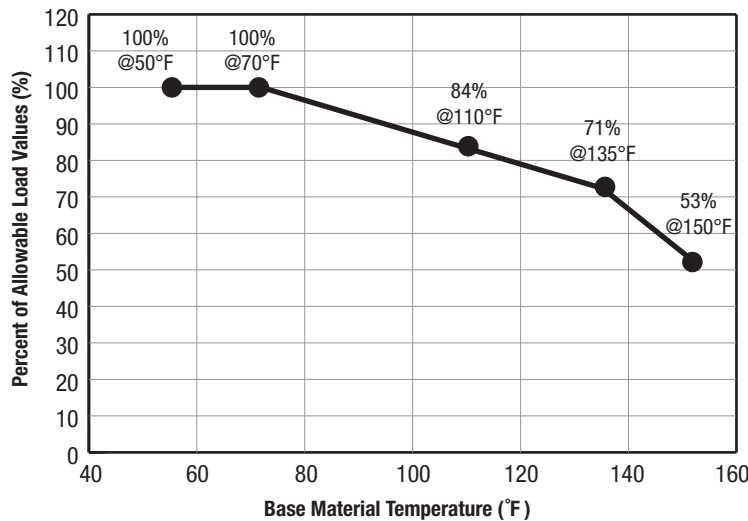
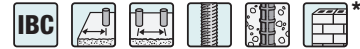

**Figure 1.** Load Capacity Based on In-Service Temperature for ET-HP Epoxy Adhesive in the Face of Fully Grouted CMU Wall Construction

\* See p. 12 for an explanation of the load table icons.

# ET-HP® Design Information — Masonry

ET-HP Edge Distance and Spacing Requirements and Allowable Load Reduction Factors — Threaded Rod and Rebar in the Face of Fully Grouted CMU Wall Construction<sup>2,7</sup>



Rod Dia. (in.) or Rebar Size No.	Minimum Embed. Depth (in.)	Edge or End Distance <sup>1,8</sup>						Spacing <sup>2,9</sup>				
		Critical (Full Anchor Capacity) <sup>3</sup>		Minimum (Reduced Anchor Capacity) <sup>4</sup>				Critical (Full Anchor Capacity) <sup>5</sup>		Minimum (Reduced Anchor Capacity) <sup>6</sup>		
		Critical Edge or End Distance, $C_{cr}$ (in.)	Allowable Load Reduction Factor	Minimum Edge or End Distance, $C_{min}$ (in.)	Allowable Load Reduction Factor		Critical Spacing, $S_{cr}$ (in.)	Allowable Load Reduction Factor	Minimum Spacing, $S_{min}$ (in.)	Allowable Load Reduction Factor		
		Load Direction		Load Direction				Load Direction		Load Direction		
		Tension or Shear	Tension or Shear	Tension or Shear	Tension	Shear <sup>10</sup>		Tension or Shear	Tension or Shear	Tension or Shear	Tension	Shear
					Perp.	Parallel						
¾	3¾	12	1.00	4	0.76	1.00	1.00	8	1.00	4	0.47	0.94
½	4½	12	1.00	4	1.00	0.92	0.9	8	1.00	4	0.60	0.96
¾	5¾	12	1.00	4	1.00	0.55	0.86	8	1.00	4	0.72	0.98
¾	6¾	12	1.00	4	1.00	0.55	0.86	8	1.00	4	0.85	1.00
#3	3¾	12	1.00	4	0.96	0.86	1.00	8	1.00	4	0.37	0.92
#4	4½	12	1.00	4	1.00	0.71	1.00	8	1.00	4	0.69	0.96
#5	5¾	12	1.00	4	1.00	0.71	1.00	8	1.00	4	1.00	1.00

- Edge distance ( $C_{cr}$  or  $C_{min}$ ) is the distance measured from anchor centerline to edge or end of CMU masonry wall. Refer to Figure 2 below for an illustration showing critical and minimum edge and end distances.
- Anchor spacing ( $S_{cr}$  or  $S_{min}$ ) is the distance measured from centerline to centerline of two anchors.
- Critical edge distance,  $C_{cr}$ , is the least edge distance at which tabulated allowable load of an anchor is achieved where a load reduction factor equals 1.0 (no load reduction).
- Minimum edge distance,  $C_{min}$ , is the least edge distance where an anchor has an allowable load capacity which shall be determined by multiplying the allowable loads assigned to anchors installed at critical edge distance,  $C_{cr}$ , by the load reduction factors shown above.
- Critical spacing,  $S_{cr}$ , is the least anchor spacing at which tabulated allowable load of an anchor is achieved such that anchor performance is not influenced by adjacent anchors.
- Minimum spacing,  $S_{min}$ , is the least spacing where an anchors has an allowable load capacity, which shall be determined by multiplying the allowable loads assigned to anchors installed at critical spacing distance,  $S_{cr}$ , by the load reduction factors shown above.
- Reduction factors are cumulative. Multiple reduction factors for more than one spacing or edge or end distance shall be calculated separately and multiplied.
- Load reduction factor for anchors loaded in tension or shear with edge distances between critical and minimum shall be obtained by linear interpolation.
- Load reduction factor for anchors loaded in tension with spacing between critical and minimum shall be obtained by linear interpolation.
- Perpendicular shear loads act towards the edge or end. Parallel shear loads act parallel to the edge or end (see Figure 3 below). Perpendicular and parallel shear load reduction factors are cumulative when the anchor is located between the critical minimum edge and end distance.

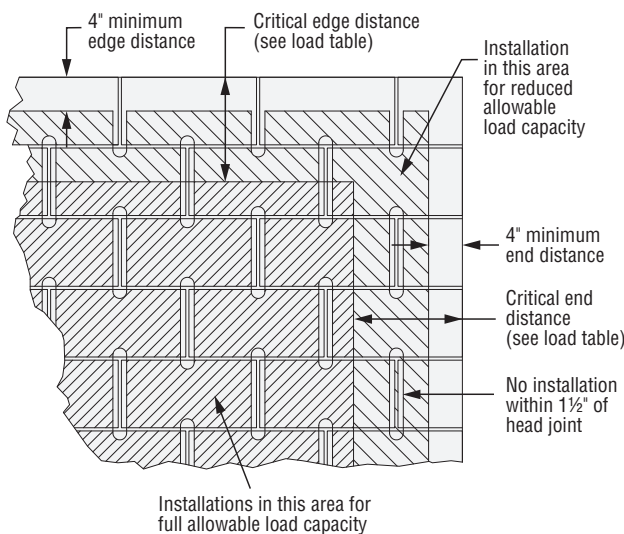

**Figure 2.** Allowable Anchor Placement in Grouted CMU Face Shell

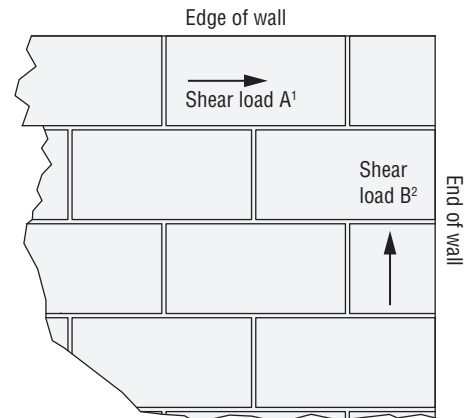

**Figure 3.** Direction of Shear Load in Relation to Edge and End of Wall

- Direction of Shear Load A is parallel to edge of wall and perpendicular to end of wall.
- Direction of Shear Load B is parallel to end of wall and perpendicular to edge of wall.

\* See p. 12 for an explanation of the load table icons.

## ET-HP® Design Information — Steel

ET-HP Allowable Tension and Shear Loads —  
Threaded Rod Based on Steel Strength<sup>1</sup>

Threaded Rod Diameter (in.)	Tensile Stress Area (in. <sup>2</sup> )	Tension Load Based on Steel Strength <sup>2</sup> (lb.)				Shear Load Based on Steel Strength <sup>3</sup> (lb.)			
		ASTM F1554 Grade 36 <sup>4</sup>	ASTM A193 Grade B7 <sup>6</sup>	Stainless Steel		ASTM F1554 Grade 36 <sup>4</sup>	ASTMA 193 Grade B7 <sup>6</sup>	Stainless Steel	
				ASTM A193 Grade B6 <sup>5</sup>	ASTM A193 Grades B8 and B8M <sup>7</sup>			ASTM A193 Grade B6 <sup>5</sup>	ASTM A193 Grades B8 and B8M <sup>7</sup>
3/8	0.078	1,495	3,220	2,830	1,930	770	1,660	1,460	995
1/2	0.142	2,720	5,860	5,155	3,515	1,400	3,020	2,655	1,810
5/8	0.226	4,325	9,325	8,205	5,595	2,230	4,805	4,225	2,880
3/4	0.334	6,395	13,780	12,125	8,265	3,295	7,100	6,245	4,260

1. Allowable load shall be the lesser of bond values given on p. 50 and steel values in the table above.
2. Allowable Tension Steel Strength is based on the following equation:  $F_v = 0.33 \times F_u \times \text{Tensile Stress Area}$ .
3. Allowable Shear Steel Strength is based on the following equation:  $F_v = 0.17 \times F_u \times \text{Tensile Stress Area}$ .
4. Minimum specified tensile strength ( $F_u = 58,000$  psi) of ASTM F1554, Grade 36 used to calculate allowable steel strength.
5. Minimum specified tensile strength ( $F_u = 110,000$  psi) of ASTM A193, Grade B6 used to calculate allowable steel strength.
6. Minimum specified tensile strength ( $F_u = 125,000$  psi) of ASTM A193, Grade B7 used to calculate allowable steel strength.
7. Minimum specified tensile strength ( $F_u = 75,000$  psi) of ASTM A193, Grades B8 and B8M used to calculate allowable steel strength.

ET-HP Allowable Tension and Shear Loads —  
Deformed Reinforcing Bar Based on Steel Strength<sup>1</sup>

Rebar Size	Tensile Stress Area (in. <sup>2</sup> )	Tension Load (lb.)		Shear Load (lb.)	
		Based on Steel Strength		Based on Steel Strength	
		ASTM A615 Grade 40 <sup>2</sup>	ASTM A615 Grade 60 <sup>3</sup>	ASTM A615 Grade 40 <sup>4,5</sup>	ASTM A615 Grade 60 <sup>4,6</sup>
#3	0.11	2,200	2,640	1,310	1,685
#4	0.20	4,000	4,800	2,380	3,060
#5	0.31	6,200	7,440	3,690	4,745

1. Allowable load shall be the lesser of bond values given on p. 50 and steel values in the table above.
2. Allowable Tension Steel Strength is based on AC58 Section 3.3.3 (20,000 psi x tensile stress area) for Grade 40 rebar.
3. Allowable Tension Steel Strength is based on AC58 Section 3.3.3 (24,000 psi x tensile stress area) for Grade 60 rebar.
4. Allowable Shear Steel Strength is based on AC58 Section 3.3.3 ( $F_v = 0.17 \times F_u \times \text{Tensile Stress Area}$ ).
5.  $F_u = 70,000$  psi for Grade 40 rebar.
6.  $F_u = 90,000$  psi for Grade 60 rebar.

\* See p. 12 for an explanation of the load table icons.

# ET-HP® Design Information — Masonry

ET-HP Allowable Tension and Shear Loads for Installations in Unreinforced Brick Masonry Walls — Minimum URM Wall Thickness is 13" (3 wythes thick)



Rod Dia. in. (mm)	Drill Bit Dia. in.	Embed. Depth in. (mm)	Min. Wall Thickness in. (mm)	Min. Edge/End Dist. in. (mm)	Min. Vertical Spacing Dist. in. (mm)	Min. Horiz. Spacing Dist. in. (mm)	Tension Load Based on URM Strength	Shear Load Based on URM Strength
							Minimum Net Mortar Strength = 50 psi	Minimum Net Mortar Strength = 50 psi
							Allowable lb. (kN)	Allowable lb. (kN)
<b>Configuration A (Simpson Strong-Tie® ETS Screen Tube Required)</b>								
3/4 (19.1)	1	8 (203)	13 (330)	24 (610)	18 (457)	18 (457)	—	1,000 (4.4)
<b>Configuration B (Simpson Strong-Tie® ETS Screen Tube Required)</b>								
3/4 (19.1)	1	Within 1" of opposite wall surface	13 (330)	16 (406)	18 (457)	24 (610)	1,200 (5.3)	1,000 (4.4)

1. Threaded rods must comply with ASTM F1554 Grade 36 minimum.
2. All holes are drilled with a 1"-diameter carbide-tipped drill bit with the drill set in the rotation-only mode.
3. The unreinforced brick walls must have a minimum thickness of 13" (three wythes of brick).
4. The allowable load is applicable only where in-place shear tests indicate minimum net mortar strength of 50 psi.
5. The allowable load for Configuration B anchor subjected to a combined tension and shear load is determined by assuming a straight-line relationship between allowable tension and shear.
6. The anchors installed in unreinforced brick walls are limited to resisting seismic or wind forces only.
7. Configuration A has a straight threaded rod or rebar embedded 8" into the wall with a 3/8"-diameter by 8"-long screen tube (part # ETS758). This configuration is designed to resist shear loads only.
8. Configuration B has a 3/4" threaded rod bent and installed at a 22.5-degree angle and installed 13" into the wall, to within 1" (maximum) of the exterior wall surface. This configuration is designed to resist tension and shear loads. The pre-bent threaded rod is installed with a 3/8" diameter by 13"-long screen tube (part # ETS7513).
9. Special inspection requirements are determined by local jurisdiction and must be confirmed by the local building official.
10. Refer to in-service temperature sensitivity chart for allowable load adjustment for temperature.

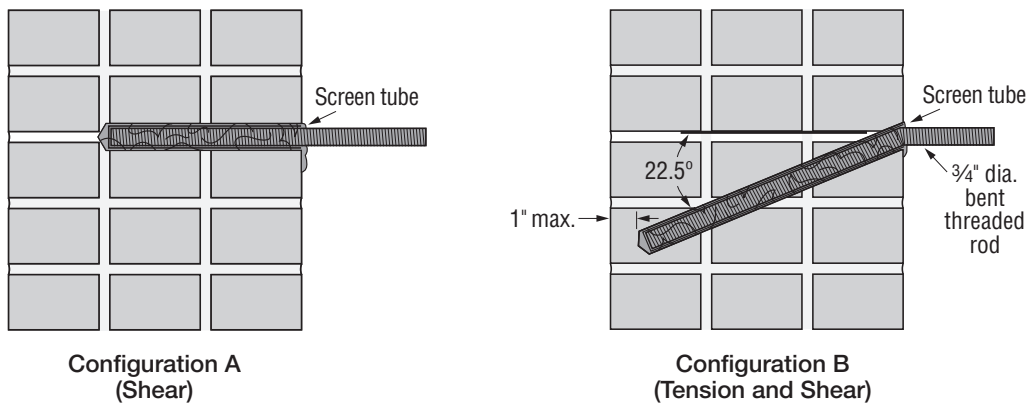

\* See p. 12 for an explanation of the load table icons.

## AT-XP® High-Strength Acrylic Adhesive

AT-XP is an acrylic-based high-strength anchoring adhesive. AT-XP is a 10:1 ratio, two-component, anchoring adhesive for use in threaded rod and rebar into concrete (cracked and uncracked) and masonry (uncracked) under a wide range of conditions. AT-XP adhesive dispenses easily in cold or warm environments and in below-freezing temperatures with no need to warm the cartridge.

### Features

- Excellent for use in cold weather conditions or applications where fast cure is required.
- Design flexibility — superior sustained load performance at elevated temperature
- Jobsite versatility — can be specified for dry and damp conditions when in-service temperatures range from -40°F (-40°C) to 180°F (82°C)
- Code listed for installation with the Speed Clean™ DXS system without any further cleaning

### Product Information

Mix Ratio/Type	10:1 acrylic
Mixed Color	Teal
Base Materials	Concrete — cracked and uncracked Masonry — uncracked
Base Material Conditions	Dry, water-saturated
Anchor Type	Threaded rod or rebar
Substrate Installation Temperature	14°F (-10°C) to 100°F (38°C)
In-Service Temperature Range	-40°F (-40°C) to 180°F (82°C)
Storage Temperature	14°F (10°C) and 80°F (27°C)
Shelf Life	18 months for AT-XP10 12 months for AT-XP13 and AT-XP30
Volatile Organic Compound (VOC)	30 g/L
Chemical Resistance	See pp. 268–269
Manufactured in the USA using global materials	

### Test Criteria

AT-XP has been tested in accordance with ICC-ES AC308, AC58, ACI 355.4 and applicable ASTM test methods.

### Code Reports, Standards and Compliance

Concrete — IAPMO UES ER-263 (including City of LA); FL16230.

Masonry — IAPMO UES ER-281 (including City of LA and Florida Building Code Supplement); FL16230.

ASTM C881 and AASHTO M235 — Types I/IV, Grade 3, Class A, B, and C except AT-XP is not an epoxy.

UL Certification — CDPH Standard Method v1.2.

NSF/ANSI/CAN 61 (43.2 in.<sup>2</sup> / 1,000 gal.).

### AT-XP Adhesive Cartridge System

Model No.	Capacity ounces (cubic in.)	Cartridge Type	Carton Qty.	Dispensing Tool	Mixing Nozzle
AT-XP10	9.4 (16.9)	Coaxial	6	CDT10S	AMN19Q
AT-XP13	12.5 (22.5)	Side-by-side	10	ADT813S	
AT-XP30	30 (54)	Side-by-side	5	ADT30S, ADTA30P or ADTA30CKT	

1. Cartridge estimation guidelines are available at [strongtie.com/softwareandwebapplications/category](http://strongtie.com/softwareandwebapplications/category).
2. Detailed information on dispensing tools, mixing nozzles and other adhesive accessories is available at [strongtie.com](http://strongtie.com).
3. Use only Simpson Strong-Tie® mixing nozzles in accordance with Simpson Strong-Tie instructions. Modification or improper use of mixing nozzle may impair AT-XP adhesive performance.
4. One AMN19Q mixing nozzle and one nozzle extension are supplied with each cartridge.
5. Use of rodless pneumatic tools to dispense single-tube, coaxial adhesive cartridges is prohibited.



AT-XP Adhesive

### Installation Instructions

Installation instructions are located at the following locations: pp. 64–67; product packaging; or [strongtie.com/atxp](http://strongtie.com/atxp).

- Hole cleaning brushes are located on p. 68.

## AT-XP® High-Strength Acrylic Adhesive

## AT-XP Cure Schedule

Base Material Temperature		Gel Time (minutes)	Cure Time (hrs.)
°F	°C		
14	-10	30	24
32	0	15	8
50	10	7	3
68	20	4	1
85	30	1½	30 min.
100	38	1	20 min.

1. For water-saturated concrete, the cure times must be doubled.
2. For installation in temperatures below 14°F (-10°C), see p. 267 (Supplemental Section) for more information.

## AT-XP Typical Properties

Property		Class A	Class B	Class C	Test Method
		(0°–40°F)	(40°–60°F)	(>60°F)	
Consistency		Non-sag	Non-sag	Non-sag	ASTM C881
Bond Strength, Slant Shear	Hardened to Hardened Concrete, 2-Day Cure <sup>1</sup>	1,900 psi	2,500 psi	3,200 psi	ASTM C882
	Hardened to Hardened Concrete, 14-Day Cure <sup>1</sup>	2,100 psi	3,750 psi	3,550 psi	
Compressive Yield Strength, 7-Day Cure <sup>2</sup>		11,800 psi	14,900 psi	18,800 psi	ASTM D695
Compressive Modulus, 7-Day Cure <sup>2</sup>		388,000 psi	565,000 psi	718,000 psi	ASTM D695
Heat Deflection Temperature, 7-Day Cure <sup>3</sup>		253°F (123°C)			ASTM D648
Glass Transition Temperature, 7-Day Cure <sup>3</sup>		266°F (130°C)			ASTM E1356
Decomposition Temperature, 24-Hour Cure <sup>3</sup>		450°F (230°C)			ASTM E2550
Water Absorption, 24-Hours, 7-Day Cure <sup>3</sup>		0.10%			ASTM D570
Shore D Hardness, 24-Hour Cure <sup>3</sup>		86			ASTM D2240
Linear Coefficient of Shrinkage, 7-Day Cure <sup>3</sup>		0.002 in./in.			ASTM D2566
Coefficient of Thermal Expansion <sup>3</sup>		3.2 x 10 <sup>-5</sup> in./in.°F			ASTM C531

1. Material and curing conditions: Class A at 35° ± 2°F, Class B at 40° ± 2°F, Class C at 60° ± 2°F.
2. Material and curing conditions: Class A at 0° ± 2°F, Class B at 40° ± 2°F, Class C at 60° ± 2°F.
3. Material and curing conditions: 73° ± 2°F.

AT-XP Installation Information and Additional Data for Threaded Rod and Rebar<sup>1</sup>

Characteristic	Symbol	Units	Nominal Anchor Diameter d <sub>a</sub> (in.) / Rebar Size						
			3/8 / #3	1/2 / #4	5/8 / #5	3/4 / #6	7/8 / #7	1 / #8	1 1/4 / #10
<b>Installation Information</b>									
Drill Bit Diameter for Threaded Rod	d <sub>hole</sub>	in.	7/16	9/16	1 1/16	1 3/16	1	1 1/8	1 3/8
Drill Bit Diameter for Rebar	d <sub>hole</sub>	in.	1/2	5/8	3/4	7/8	1	1 1/8	1 3/8
Maximum Tightening Torque	T <sub>inst</sub>	ft.-lb.	10	20	30	45	60	80	125
Permitted Embedment Depth Range <sup>2</sup>	Minimum	h <sub>ef</sub>	2 3/8	2 3/4	3 1/8	3 1/2	3 3/4	4	5
	Maximum	h <sub>ef</sub>	7 1/2	10	12 1/2	15	17 1/2	20	25
Minimum Concrete Thickness	h <sub>min</sub>	in.	h <sub>ef</sub> + 1 1/4			h <sub>ef</sub> + 2d <sub>hole</sub>			
Critical Edge Distance <sup>2</sup>	c <sub>ac</sub>	in.	See footnote 2						
Minimum Edge Distance	c <sub>min</sub>	in.	1 3/4						2 3/4
Minimum Anchor Spacing	s <sub>min</sub>	in.	3						6

1. The information presented in this table is to be used in conjunction with the design criteria of ACI 318-14 and ACI 318-11.

2.  $c_{ac} = h_{ef} (\tau_{k,uncr} / 1,160)^{0.4} \times [3.1 - 0.7(h/h_{ef})]$ , where:  
 $[h/h_{ef}] \leq 2.4$

$\tau_{k,uncr}$  = the characteristic bond strength in uncracked concrete, given in the tables that follow  $\leq k_{uncr} ((h_{ef} \times f'_c)^{0.5} / (\pi \times d_a))$

$h$  = the member thickness (inches)

$h_{ef}$  = the embedment depth (inches)

\* See p. 12 for an explanation of the load table icons.

# AT-XP® Design Information — Concrete

## AT-XP Tension Strength Design Data for Threaded Rod<sup>1</sup>



Characteristic		Symbol	Units	Nominal Anchor Diameter $d_a$ (in.)							
				3/8	1/2	5/8	3/4	7/8	1	1 1/4	
<b>Steel Strength in Tension</b>											
Threaded Rod	Minimum Tensile Stress Area	$A_{se}$	in. <sup>2</sup>	0.078	0.142	0.226	0.334	0.462	0.606	0.969	
	Tension Resistance of Steel — ASTM F1554, Grade 36	$N_{sa}$	lb.	4,525	8,235	13,110	19,370	26,795	35,150	56,200	
	Tension Resistance of Steel — ASTM A193, Grade B7			9,750	17,750	28,250	41,750	57,750	75,750	121,125	
	Tension Resistance of Steel — Type 410 Stainless (ASTM A193, Grade B6)			8,580	15,620	24,860	36,740	50,820	66,660	106,590	
	Tension Resistance of Steel — Type 304 and 316 Stainless (ASTM A193, Grade B8 and B8M)			4,445	8,095	12,880	19,040	26,335	34,540	55,235	
	Strength Reduction Factor — Steel Failure			$\phi$	—	0.75 <sup>6</sup>					
<b>Concrete Breakout Strength in Tension (2,500 psi ≤ <math>f'_c</math> ≤ 8,000 psi)</b>											
Effectiveness Factor — Uncracked Concrete		$k_{uncr}$	—	24							
Effectiveness Factor — Cracked Concrete		$k_{cr}$	—	17							
Strength Reduction Factor — Breakout Failure		$\phi$	—	0.65 <sup>8</sup>							
<b>Bond Strength in Tension (2,500 psi ≤ <math>f'_c</math> ≤ 8,000 psi)</b>											
Uncracked Concrete <sup>2,3,4</sup>	Characteristic Bond Strength	$\tau_{k,uncr}$	psi	1,390	1,590	1,715	1,770	1,750	1,655	1,250	
	Permitted Embedment Depth Range	Minimum	$h_{ef}$	in.	2 3/8	2 3/4	3 1/8	3 1/2	3 3/4	4	5
		Maximum	$h_{ef}$	in.	7 1/2	10	12 1/2	15	17 1/2	20	25
Cracked Concrete <sup>2,3,4</sup>	Characteristic Bond Strength <sup>9,10,11</sup>	$\tau_{k,cr}$	psi	1,085	1,035	980	950	815	800	700	
	Permitted Embedment Depth Range	Minimum	$h_{ef}$	in.	3	3	3 1/8	3 1/2	3 3/4	4	5
		Maximum	$h_{ef}$	in.	7 1/2	10	12 1/2	15	17 1/2	20	25
<b>Bond Strength in Tension — Bond Strength Reduction Factors for Continuous Special Inspection</b>											
Strength Reduction Factor — Dry Concrete		$\phi_{dry}$	—	0.65 <sup>7</sup>							
Strength Reduction Factor — Water-Saturated Concrete		$\phi_{sat}$	—	0.45 <sup>7</sup>							
Additional Factor for Water-Saturated Concrete		$K_{sat}$	—	0.54 <sup>5</sup>			0.77 <sup>5</sup>		0.96 <sup>5</sup>		
<b>Bond Strength in Tension — Bond Strength Reduction Factors for Periodic Special Inspection</b>											
Strength Reduction Factor — Dry Concrete		$\phi_{dry}$	—	0.55 <sup>7</sup>							
Strength Reduction Factor — Water-Saturated Concrete		$\phi_{sat}$	—	0.45 <sup>7</sup>							
Additional Factor for Water-Saturated Concrete		$K_{sat}$	—	0.46 <sup>5</sup>			0.65 <sup>5</sup>		0.81 <sup>5</sup>		

- The information presented in this table is to be used in conjunction with the design criteria of ACI 318-14 and ACI 318-11.
- Temperature Range: Maximum short-term temperature of 180°F. Maximum long-term temperature of 110°F.
- Short-term concrete temperatures are those that occur over short intervals (diurnal cycling).
- Long-term concrete temperatures are constant temperatures over a significant time period.
- In water-saturated concrete, multiply  $\tau_{k,uncr}$  and  $\tau_{k,cr}$  by  $K_{sat}$ .
- The value of  $\phi$  applies when the load combinations of ACI 318-14 5.3 or ACI 318-11 Section 9.2 are used. If the load combinations of ACI 318 Appendix C are used, refer to ACI 318-11 D.4.4 to determine the appropriate value of  $\phi$ .
- The value of  $\phi$  applies when both the load combinations of ACI 318-14 5.3 or ACI 318-11 Section 9.2 are used and the requirements of ACI 318-14 17.3.3 or ACI 318-11 D.4.3 (c) for Condition B are met. If the load combinations of ACI 318 Appendix C are used, refer to ACI 318-11 D.4.4 to determine the appropriate value of  $\phi$ .
- The value of  $\phi$  applies when both the load combinations of ACI 318-14 5.3 or ACI 318-11 Section 9.2 are used and the requirements of ACI 318-14 17.3.3 or ACI 318-11 D.4.3 (c) for Condition B are met. If the load combinations of ACI 318 Section 9.2 are used and the requirements of ACI 318-11 D.4.3 (c) for Condition A are met, refer to ACI 318-11 D.4.4 to determine the appropriate value of  $\phi$ . If the load combinations of ACI 318 Appendix C are used, refer to ACI 318-11 D.4.4 to determine the appropriate value of  $\phi$ .
- For anchors installed in regions assigned to Seismic Design Category C, D, E or F, the bond strength values for 1/2", 5/8", 3/4" and 1" anchors must be multiplied by  $\alpha_{N,seis} = 0.85$ .
- For anchors installed in regions assigned to Seismic Design Category C, D, E or F, the bond strength values for 1 1/4" anchors must be multiplied by  $\alpha_{N,seis} = 0.75$ .
- For anchors installed in regions assigned to Seismic Design Category C, D, E or F, the bond strength values for 7/8" anchors must be multiplied by  $\alpha_{N,seis} = 0.59$ .

\* See p. 12 for an explanation of the load table icons.



# AT-XP® Design Information — Concrete

## AT-XP Tension Strength Design Data for Rebar<sup>1</sup>



Characteristic		Symbol	Units	Rebar Size							
				#3	#4	#5	#6	#7	#8	#10	
<b>Steel Strength in Tension</b>											
Rebar	Minimum Tensile Stress Area	$A_{se}$	in. <sup>2</sup>	0.11	0.2	0.31	0.44	0.6	0.79	1.27	
	Tension Resistance of Steel — Rebar (ASTM A615 Grade 60)	$N_{sa}$	lb.	9,900	18,000	27,900	39,600	54,000	71,100	114,000	
	Tension Resistance of Steel — Rebar (ASTM A706 Grade 60)			8,800	16,000	24,800	35,200	48,000	63,200	101,600	
	Strength Reduction Factor — Steel Failure	$\phi$	—	0.75 <sup>6</sup>							
<b>Concrete Breakout Strength in Tension (2,500 psi ≤ f<sub>c</sub> ≤ 8,000 psi)</b>											
Effectiveness Factor — Uncracked Concrete		$k_{uncr}$	—	24							
Effectiveness Factor — Cracked Concrete		$k_{cr}$	—	17							
Strength Reduction Factor — Breakout Failure		$\phi$	—	0.65 <sup>8</sup>							
<b>Bond Strength in Tension (2,500 psi ≤ f<sub>c</sub> ≤ 8,000 psi)</b>											
Uncracked Concrete <sup>2,3,4</sup>	Characteristic Bond Strength		$\tau_{k,uncr}$	psi	1,010	990	970	955	935	915	875
	Permitted Embedment Depth Range	Minimum	$h_{ef}$	in.	2 <sup>3</sup> / <sub>8</sub>	2 <sup>3</sup> / <sub>4</sub>	3 <sup>1</sup> / <sub>8</sub>	3 <sup>1</sup> / <sub>2</sub>	3 <sup>3</sup> / <sub>4</sub>	4	5
		Maximum			7 <sup>1</sup> / <sub>2</sub>	10	12 <sup>1</sup> / <sub>2</sub>	15	17 <sup>1</sup> / <sub>2</sub>	20	25
Cracked Concrete <sup>2,3,4</sup>	Characteristic Bond Strength		$\tau_{k,cr}$	psi	340	770	780	790	795	795	820
	Permitted Embedment Depth Range	Minimum	$h_{ef}$	in.	3	3	3 <sup>1</sup> / <sub>8</sub>	3 <sup>1</sup> / <sub>2</sub>	3 <sup>3</sup> / <sub>4</sub>	4	5
		Maximum			7 <sup>1</sup> / <sub>2</sub>	10	12 <sup>1</sup> / <sub>2</sub>	15	17 <sup>1</sup> / <sub>2</sub>	20	25
<b>Bond Strength in Tension — Bond Strength Reduction Factors for Continuous Special Inspection</b>											
Strength Reduction Factor — Dry Concrete		$\phi_{dry}$	—	0.65 <sup>7</sup>					0.55 <sup>7</sup>		
Strength Reduction Factor — Water-Saturated Concrete		$\phi_{sat}$	—	0.45 <sup>7</sup>							
Additional Factor for Water-Saturated Concrete		$K_{sat}$	—	0.54 <sup>5</sup>			0.77 <sup>5</sup>		0.96 <sup>5</sup>		
<b>Bond Strength in Tension — Bond Strength Reduction Factors for Periodic Special Inspection</b>											
Strength Reduction Factor — Dry Concrete		$\phi_{dry}$	—	0.55 <sup>7</sup>					0.45 <sup>7</sup>		
Strength Reduction Factor — Water-Saturated Concrete		$\phi_{sat}$	—	0.45 <sup>7</sup>							
Additional Factor for Water-Saturated Concrete		$K_{sat}$	—	0.46 <sup>5</sup>			0.65 <sup>5</sup>		0.81 <sup>5</sup>		

- The information presented in this table is to be used in conjunction with the design criteria of ACI 318-14 and ACI 318-11.
- Temperature Range: Maximum short-term temperature of 180°F. Maximum long-term temperature of 110°F.
- Short-term concrete temperatures are those that occur over short intervals (diurnal cycling).
- Long-term concrete temperatures are constant temperatures over a significant time period.
- In water-saturated concrete, multiply  $\tau_{k,uncr}$  and  $\tau_{k,cr}$  by  $K_{sat}$ .
- The value of  $\phi$  applies when the load combinations of ACI 318-14 5.3 or ACI 318-11 Section 9.2 are used. If the load combinations of ACI 318 Appendix C are used, refer to ACI 318-11 D.4.4 to determine the appropriate value of  $\phi$ .
- The value of  $\phi$  applies when both the load combinations of ACI 318-14 5.3 or ACI 318-11 Section 9.2 are used and the requirements of ACI 318-14 17.3.3 or ACI 318-11 D.4.3 (c) for Condition B are met. If the load combinations of ACI 318 Appendix C are used, refer to ACI 318-11 D.4.4 to determine the appropriate value of  $\phi$ .
- The value of  $\phi$  applies when both the load combinations of ACI 318-14 5.3 or ACI 318-11 Section 9.2 are used and the requirements of ACI 318-14 17.3.3 or ACI 318-11 D.4.3 (c) for Condition B are met. If the load combinations of ACI 318 Section 9.2 are used and the requirements of ACI 318-11 D.4.3 (c) for Condition A are met, refer to ACI 318-11 D.4.4 to determine the appropriate value of  $\phi$ . If the load combinations of ACI 318 Appendix C are used, refer to ACI 318-11 D.4.4 to determine the appropriate value of  $\phi$ .

\* See p. 12 for an explanation of the load table icons.

# AT-XP® Design Information — Concrete

## AT-XP Shear Strength Design Data for Threaded Rod<sup>1</sup>



Characteristic		Symbol	Units	Nominal Anchor Diameter (in.)						
				3/8	1/2	5/8	3/4	7/8	1	1 1/4
<b>Steel Strength in Shear</b>										
Threaded Rod	Minimum Shear Stress Area	$A_{se}$	in. <sup>2</sup>	0.078	0.142	0.226	0.334	0.462	0.606	0.969
	Shear Resistance of Steel — ASTM F1554, Grade 36	$V_{sa}$	lb.	2,260	4,940	7,865	11,625	16,080	21,090	33,720
	Shear Resistance of Steel — ASTM A193, Grade B7			4,875	10,650	16,950	25,050	34,650	45,450	72,675
	Shear Resistance of Steel — Type 410 Stainless (ASTM A193, Grade B6)	$V_{sa}$	lb.	4,290	9,370	14,910	22,040	30,490	40,000	63,955
	Shear Resistance of Steel — Type 304 and 316 Stainless (ASTM A193, Grade B8 and B8M)			2,225	4,855	7,730	11,425	15,800	20,725	33,140
	Reduction for Seismic Shear — ASTM F1554, Grade 36	$\alpha_{V,seis}$ <sup>5</sup>	—	0.85						
	Reduction for Seismic Shear — ASTM A193, Grade B7			0.85						
	Reduction for Seismic Shear — Type 410 Stainless (ASTM A193, Grade B6)			0.85	0.75				0.85	
	Reduction for Seismic Shear — Type 304 and 316 Stainless (ASTM A193, Grade B8 and B8M)			0.85	0.75				0.85	
	Strength Reduction Factor — Steel Failure	$\phi$	—	0.65 <sup>2</sup>						
<b>Concrete Breakout Strength in Shear</b>										
Diameter of Anchor	$d_a$	in.	0.375	0.5	0.625	0.75	0.875	1	1.25	
Load-Bearing Length of Anchor in Shear	$\ell_e$	in.	Min. of $h_{ef}$ and 8 times anchor diameter							
Strength Reduction Factor — Breakout Failure	$\phi$	—	0.70 <sup>3</sup>							
<b>Concrete Pryout Strength in Shear</b>										
Coefficient for Pryout Strength	$k_{cp}$	—	1.0 for $h_{ef} < 2.50"$ ; 2.0 for $h_{ef} \geq 2.50"$							
Strength Reduction Factor — Pryout Failure	$\phi$	—	0.70 <sup>4</sup>							

- The information presented in this table is to be used in conjunction with the design criteria of ACI 318-14 and ACI 318-11.
- The value of  $\phi$  applies when the load combinations of ACI 318-14 5.3 or ACI 318-11 Section 9.2 are used.  
If the load combinations of ACI 318 Appendix C are used, refer to ACI 318-11 D.4.4 to determine the appropriate value of  $\phi$ .
- The value of  $\phi$  applies when both the load combinations of ACI 318-14 5.3 or ACI 318-11 Section 9.2 are used and the requirements of ACI 318-14 17.3.3 or ACI 318-11 D.4.3 (c) for Condition B are met. If the load combinations of ACI 318 Section 9.2 are used and the requirements of ACI 318-11 D.4.3 (c) for Condition A are met, refer to ACI 318-11 D.4.4 to determine the appropriate value of  $\phi$ .  
If the load combinations of ACI 318 Appendix C are used, refer to ACI 318-11 D.4.4 to determine the appropriate value of  $\phi$ .
- The value of  $\phi$  applies when both the load combinations of ACI 318-14 5.3 or ACI 318-11 Section 9.2 are used and the requirements of ACI 318-14 17.3.3 or ACI 318-11 D.4.3 (c) for Condition B are met. If the load combinations of ACI 318 Appendix C are used, refer to ACI 318-11 D.4.4 to determine the appropriate value of  $\phi$ .
- The values of  $V_{sa}$  are applicable for both cracked concrete and uncracked concrete. For anchors installed in regions assigned to Seismic Design Category C, D, E or F,  $V_{sa}$  must be multiplied by  $\alpha_{V,seis}$  for the corresponding anchor steel type.

\* See p. 12 for an explanation of the load table icons.

# AT-XP® Design Information — Concrete

## AT-XP Shear Strength Design Data for Rebar<sup>1</sup>



Characteristic		Symbol	Units	Rebar Size						
				#3	#4	#5	#6	#7	#8	#10
<b>Steel Strength in Shear</b>										
Rebar	Minimum Shear Stress Area	$A_{se}$	in. <sup>2</sup>	0.11	0.2	0.31	0.44	0.6	0.79	1.27
	Shear Resistance of Steel — Rebar (ASTM A615 Grade 60)	$V_{sa}$	lb.	4,950	10,800	16,740	23,760	32,400	42,660	68,580
	Shear Resistance of Steel — Rebar (ASTM A706 Grade 60)			4,400	9,600	14,880	21,120	28,800	37,920	60,960
	Reduction for Seismic Shear — Rebar (ASTM A615 Grade 60)	$\alpha_{V_{seis}}$ <sup>5</sup>	—	0.56				0.80		
	Reduction for Seismic Shear — Rebar (ASTM A706 Grade 60)			0.56				0.80		
	Strength Reduction Factor — Steel Failure	$\phi$	—	0.65 <sup>2</sup>						
<b>Concrete Breakout Strength in Shear</b>										
Diameter of Anchor	$d_a$	in.	0.375	0.5	0.625	0.75	0.875	1	1.25	
Load-Bearing Length of Anchor in Shear	$\ell_e$	in.	Min. of $h_{ef}$ and 8 times anchor diameter							
Strength Reduction Factor — Breakout Failure	$\phi$	—	0.70 <sup>3</sup>							
<b>Concrete Pryout Strength in Shear</b>										
Coefficient for Pryout Strength	$k_{cp}$	—	1.0 for $h_{ef} < 2.50"$ ; 2.0 for $h_{ef} \geq 2.50"$							
Strength Reduction Factor — Pryout Failure	$\phi$	—	0.70 <sup>4</sup>							

- The information presented in this table is to be used in conjunction with the design criteria of ACI 318-14 and ACI 318-11.
- The value of  $\phi$  applies when the load combinations of ACI 318-14 5.3 or ACI 318-11 Section 9.2 are used. If the load combinations of ACI 318 Appendix C are used, refer to ACI 318-11 D.4.4 to determine the appropriate value of  $\phi$ .
- The value of  $\phi$  applies when both the load combinations of ACI 318-14 5.3 or ACI 318-11 Section 9.2 are used and the requirements of ACI 318-14 17.3.3 or ACI 318-11 D.4.3 (c) for Condition B are met. If the load combinations of ACI 318 Section 9.2 are used and the requirements of ACI 318-11 D.4.3 (c) for Condition A are met, refer to ACI 318-11 D.4.4 to determine the appropriate value of  $\phi$ . If the load combinations of ACI 318 Appendix C are used, refer to ACI 318-11 D.4.4 to determine the appropriate value of  $\phi$ .
- The value of  $\phi$  applies when both the load combinations of ACI 318-14 5.3 or ACI 318-11 Section 9.2 are used and the requirements of ACI 318-14 17.3.3 or ACI 318-11 D.4.3 (c) for Condition B are met. If the load combinations of ACI 318 Appendix C are used, refer to ACI 318-11 D.4.4 to determine the appropriate value of  $\phi$ .
- The values of  $V_{sa}$  are applicable for both cracked concrete and uncracked concrete. For anchors installed in regions assigned to Seismic Design Category C, D, E or F,  $V_{sa}$  must be multiplied by  $\alpha_{V_{seis}}$  for the corresponding anchor steel type.

For additional load tables, visit [strongtie.com/atxp](http://strongtie.com/atxp).



## Anchor Designer™ Software for ACI 318, ETAG and CSA

Simpson Strong-Tie® Anchor Designer software accurately analyzes existing design or suggests anchor solutions based on user-defined design elements in cracked and uncracked concrete conditions.

\* See p. 12 for an explanation of the load table icons.

# AT-XP® Design Information — Masonry

AT-XP Allowable Tension and Shear Loads for Threaded Rod and Rebar in the Face of Fully Grouted CMU Wall Construction<sup>1, 3, 4, 5, 6, 8, 9, 10, 11</sup>

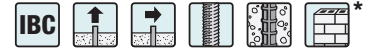

Diameter (in.) or Rebar Size No.	Drill Bit Diameter (in.)	Minimum Embedment <sup>2</sup> (in.)	Allowable Load Based on Bond Strength <sup>7</sup> (lb.)	
			Tension Load	Shear Load
<b>Threaded Rod Installed in the Face of CMU Wall</b>				
3/8	1/2	3 3/8	1,265	1,135
1/2	5/8	4 1/2	1,910	1,660
5/8	3/4	5 5/8	2,215	1,810
3/4	7/8	6 3/4	2,260	1,810
<b>Rebar Installed in the Face of CMU Wall</b>				
#3	1/2	3 3/8	1,180	1,315
#4	5/8	4 1/2	1,720	1,565
#5	3/4	5 5/8	1,835	1,565

1. Allowable load shall be the lesser of the bond values shown in this table and steel values, shown on p. 62.
2. Embedment depth shall be measured from the outside face of masonry wall.
3. Critical and minimum edge distance and spacing shall comply with the information on p. 61. Figure 2 on p. 61 illustrates critical and minimum edge and end distances.
4. Minimum allowable nominal width of CMU wall shall be 8". No more than one anchor shall be permitted per masonry cell.
5. Anchors shall be permitted to be installed at any location in the face of the fully grouted masonry wall construction (cell, web, bed joint), except anchors shall not be installed within 1 1/2" of the head joint, as show in Figure 2 on p. 61.
6. Tabulated allowable load values are for anchors installed in fully grouted masonry walls.
7. Tabulated allowable loads are based on a safety factor of 5.0.
8. Tabulated allowable load values shall be adjusted for increased base material temperatures in accordance with Figure 1 below, as applicable.
9. Threaded rod and rebar installed in fully grouted masonry walls are permitted to resist dead, live, seismic and wind loads.
10. Threaded rod shall meet or exceed the tensile strength of ASTM F1554, Grade 36 steel, which is 58,000 psi.
11. For installations exposed to severe, moderate or negligible exterior weathering conditions, as defined in Figure 1 of ASTM C62, allowable tension loads shall be multiplied by 0.80.

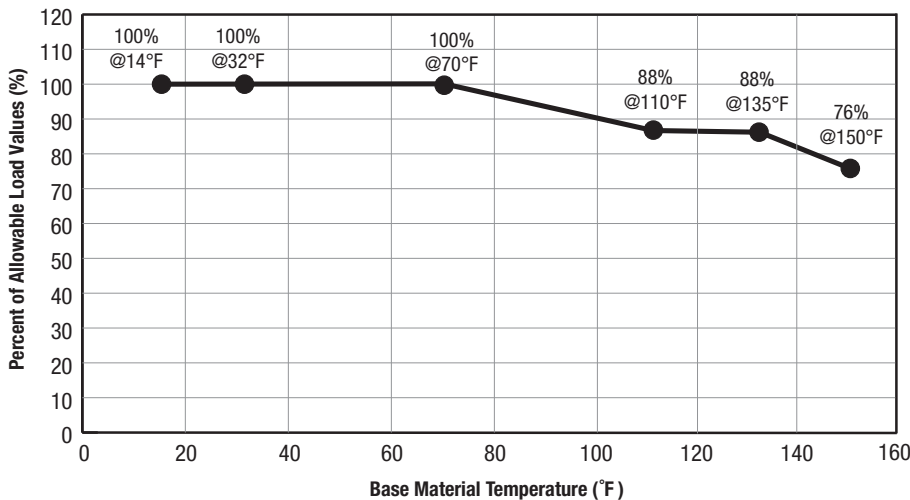
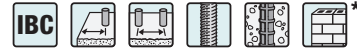

**Figure 1.** Load Capacity Based on In-Service Temperature for AT-XP Adhesive in the Face of Fully Grouted CMU Wall Construction

\* See p. 12 for an explanation of the load table icons.

# AT-XP® Design Information — Masonry

AT-XP Edge Distance and Spacing Requirements and Allowable Load Reduction Factors — Threaded Rod and Rebar in the Face of Fully Grouted CMU Wall Construction<sup>7</sup>



Rod Dia. (in.) or Rebar Size No.	Minimum Embed. Depth (in.)	Edge or Edge Distance <sup>1,8</sup>						Spacing <sup>2,9</sup>				
		Critical (Full Anchor Capacity) <sup>3</sup>		Minimum (Reduced Anchor Capacity) <sup>4</sup>				Critical (Full Anchor Capacity) <sup>5</sup>		Minimum (Reduced Anchor Capacity) <sup>6</sup>		
		Critical Edge or End Distance, $C_{cr}$ (in.)	Allowable Load Reduction Factor	Minimum Edge or End Distance, $C_{min}$ (in.)	Allowable Load Reduction Factor			Critical Spacing, $S_{cr}$ (in.)	Allowable Load Reduction Factor	Minimum Spacing, $S_{min}$ (in.)	Allowable Load Reduction Factor	
		Load Direction		Load Direction				Load Direction		Load Direction		
		Tension or Shear	Tension or Shear	Tension or Shear	Tension	Shear <sup>10</sup>		Tension or Shear	Tension or Shear	Tension or Shear	Tension	Shear
					Perp.	Para.						
3/8	3 3/8	12	1.00	4	1.00	0.76	0.94	8	1.00	4	1.00	1.00
1/2	4 1/2	12	1.00	4	0.90	0.57	0.94	8	1.00	4	1.00	1.00
5/8	5 5/8	12	1.00	4	0.72	0.47	0.94	8	1.00	4	1.00	1.00
3/4	6 3/4	12	1.00	4	0.72	0.47	0.94	8	1.00	4	1.00	1.00
#3	3 3/8	12	1.00	4	1.00	0.62	0.95	8	1.00	4	1.00	1.00
#4	4 1/2	12	1.00	4	1.00	0.37	0.82	8	1.00	4	1.00	0.89
#5	5 5/8	12	1.00	4	1.00	0.37	0.82	8	1.00	4	1.00	0.89

- Edge distance ( $C_{cr}$  or  $C_{min}$ ) is the distance measured from anchor centerline to edge or end of CMU masonry wall. Refer to Figure 2 below for an illustration showing critical and minimum edge and end distances.
- Anchor spacing ( $S_{cr}$  or  $S_{min}$ ) is the distance measured from centerline to centerline of two anchors.
- Critical edge distance,  $C_{cr}$ , is the least edge distance at which tabulated allowable load of an anchor is achieved where a load reduction factor equals 1.0 (no load reduction).
- Minimum edge distance,  $C_{min}$ , is the least edge distance where an anchor has an allowable load capacity which shall be determined by multiplying the allowable loads assigned to anchors installed at critical edge distance,  $C_{cr}$ , by the load reduction factors shown above.
- Critical spacing,  $S_{cr}$ , is the least anchor spacing at which tabulated allowable load of an anchor is achieved such that anchor performance is not influenced by adjacent anchors.
- Minimum spacing,  $S_{min}$ , is the least spacing where an anchors has an allowable load capacity, which shall be determined by multiplying the allowable loads assigned to anchors installed at critical spacing distance,  $S_{cr}$ , by the load reduction factors shown above.
- Reduction factors are cumulative. Multiple reduction factors for more than one spacing or edge or end distance shall be calculated separately and multiplied.
- Load reduction factor for anchors loaded in tension or shear with edge distances between critical and minimum shall be obtained by linear interpolation.
- Load reduction factor for anchors loaded in tension with spacing between critical and minimum shall be obtained by linear interpolation.
- Perpendicular shear loads act towards the edge or end. Parallel shear loads act parallel to the edge or end (see Figure 3 below). Perpendicular and parallel shear load reduction factors are cumulative when the anchor is located between the critical minimum edge and end distance.

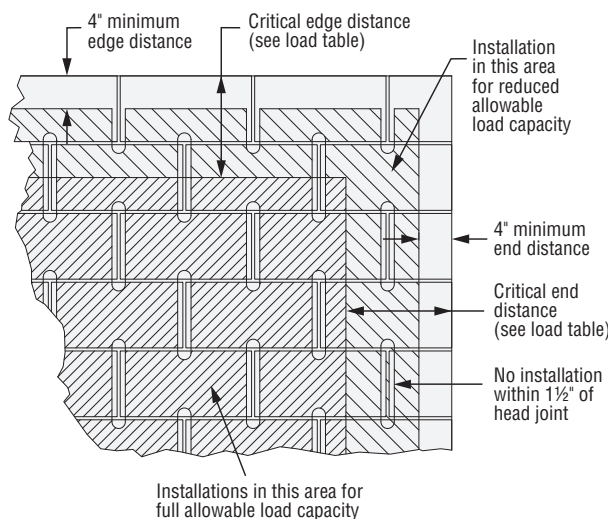

**Figure 2.** Allowable Anchor Locations for Full and Reduced Load Capacity When Installation Is in the Face of Fully Grouted CMU Masonry Wall Construction

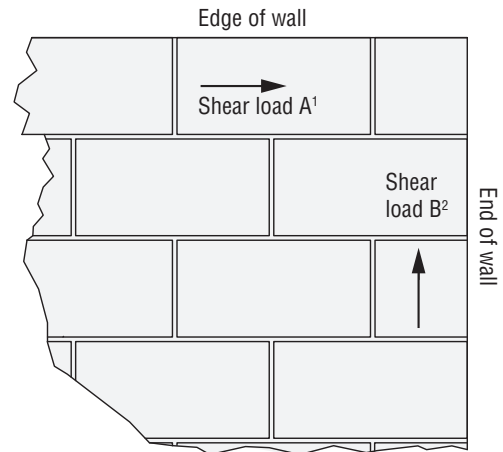

**Figure 3.** Direction of Shear Load in Relation to Edge and End of Wall

- Direction of Shear Load A is parallel to edge of wall and perpendicular to end of wall.
- Direction of Shear Load B is parallel to end of wall and perpendicular to edge of wall.

\* See p. 12 for an explanation of the load table icons.

# AT-XP® Design Information — Steel

## AT-XP Allowable Tension and Shear Loads — Threaded Rod Based on Steel Strength<sup>1</sup>

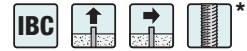

Threaded Rod Diameter (in.)	Tensile Stress Area (in. <sup>2</sup> )	Tension Load Based on Steel Strength <sup>2</sup> (lb.)				Shear Load Based on Steel Strength <sup>3</sup> (lb.)			
		ASTM F1554 Grade 36 <sup>4</sup>	ASTM A193 Grade B7 <sup>6</sup>	Stainless Steel		ASTM F1554 Grade 36 <sup>4</sup>	ASTM A193 Grade B7 <sup>6</sup>	Stainless Steel	
				ASTM A193 Grade B6 <sup>5</sup>	ASTM A193 Grades B8 and B8M <sup>7</sup>			ASTM A193 Grade B6 <sup>5</sup>	ASTM A193 Grades B8 and B8M <sup>7</sup>
3/8	0.078	1,495	3,220	2,830	1,930	770	1,660	1,460	995
1/2	0.142	2,720	5,860	5,155	3,515	1,400	3,020	2,655	1,810
5/8	0.226	4,325	9,325	8,205	5,595	2,230	4,805	4,225	2,880
3/4	0.334	6,395	13,780	12,125	8,265	3,295	7,100	6,245	4,260

1. Allowable load shall be the lesser of bond values given on p. 60 and steel values in the table above.
2. Allowable Tension Steel Strength is based on the following equation:  $F_v = 0.33 \times F_u \times \text{Tensile Stress Area}$ .
3. Allowable Shear Steel Strength is based on the following equation:  $F_v = 0.17 \times F_u \times \text{Tensile Stress Area}$ .
4. Minimum specified tensile strength ( $F_u = 58,000$  psi) of ASTM F1554, Grade 36 used to calculate allowable steel strength.
5. Minimum specified tensile strength ( $F_u = 110,000$  psi) of ASTM A193, Grade B6 used to calculate allowable steel strength.
6. Minimum specified tensile strength ( $F_u = 125,000$  psi) of ASTM A193, Grade B7 used to calculate allowable steel strength.
7. Minimum specified tensile strength ( $F_u = 75,000$  psi) of ASTM A193, Grades B8 and B8M used to calculate allowable steel strength.

## AT-XP Allowable Tension and Shear Loads — Deformed Reinforcing Bar Based on Steel Strength<sup>1</sup>



Drill Bit Diameter (in.)	Minimum Embedment <sup>2</sup> (in.)	Tension Load (lb.)		Shear Load (lb.)	
		Based on Steel Strength		Based on Steel Strength	
		ASTM A615 Grade 40 <sup>2</sup>	ASTM A615 Grade 60 <sup>3</sup>	ASTM A615 Grade 40 <sup>4,5</sup>	ASTM A615 Grade 60 <sup>4,6</sup>
#3	0.11	2,200	2,640	1,310	1,685
#4	0.20	4,000	4,800	2,380	3,060
#5	0.31	6,200	7,440	3,690	4,745

1. Allowable load shall be the lesser of bond values given on p. 60 and steel values in the table above.
2. Allowable Tension Steel Strength is based on AC58 Section 3.3.3 (20,000 psi x tensile stress area) for Grade 40 rebar.
3. Allowable Tension Steel Strength is based on AC58 Section 3.3.3 (24,000 psi x tensile stress area) for Grade 60 rebar.
4. Allowable Shear Steel Strength is based on AC58 Section 3.3.3 ( $F_v = 0.17 \times F_u \times \text{Tensile Stress Area}$ ).
5.  $F_u = 70,000$  psi for Grade 40 rebar.
6.  $F_u = 90,000$  psi for Grade 60 rebar.

\* See p. 12 for an explanation of the load table icons.

# AT-XP® Design Information — Masonry

## AT-XP Allowable Tension and Shear Loads — Threaded Rod in the Face of Hollow CMU Wall Construction<sup>1,3,4,5,6,8,9,10,11</sup>



Diameter (in.)	Drill Bit Diameter (in.)	Minimum Embedment Depth <sup>2</sup> (in.)	Allowable Load Based on Bond Strength <sup>7</sup> (lb.)	
			Tension	Shear
3/8	9/16	1 1/4	225	275
1/2	3/4	1 1/4	220	315
5/8	7/8	1 1/4	215	355

1. Allowable load shall be the lesser of bond values shown in this table and steel values shown on p. 62.
2. Embedment depth is considered the minimum wall thickness of 8" x 8" x 16" ASTM C90 concrete masonry blocks, and is measured from the outside to the inside face of the block wall. The minimum length Opti-Mesh plastic screen tube for use in hollow CMU is 3 1/2".
3. Critical and minimum edge distance and spacing shall comply with the information provided on p. 63. Figure 4 on p. 63 illustrates critical and minimum edge and end distances.
4. Anchors are permitted to be installed in the face shell of hollow masonry wall construction as shown in Figure 4.
5. Anchors are limited to one or two anchors per masonry cell and must comply with the spacing and edge distance requirements provided.
6. Tabulated load values are for anchors installed in hollow masonry walls.
7. Tabulated allowable loads are based on a safety factor of 5.0.
8. Tabulated allowable load values shall be adjusted for increased base material temperatures in accordance with Figure 1 on p. 60, as applicable.
9. Threaded rods installed in hollow masonry walls with AT-XP adhesive are permitted to resist dead, live load and wind load applications.
10. Threaded rods must meet or exceed the tensile strength of ASTM F1554, Grade 36, which is 58,000 psi.
11. For installations exposed to severe, moderate or negligible exterior weathering conditions, as defined in Figure 1 of ASTM C62, allowable tension loads must be multiplied by 0.80.

## AT-XP Edge, End and Spacing Distance Requirements and Allowable Load Reduction Factors — Threaded Rod in the Face of Hollow CMU Wall Construction<sup>7</sup>



Rod Diameter (in.)	Edge or End Distance <sup>1,8</sup>					Spacing <sup>2,9</sup>					
	Critical (Full Anchor Capacity) <sup>3</sup>		Minimum (Reduced Anchor Capacity) <sup>4</sup>			Critical (Full Anchor Capacity) <sup>5</sup>		Minimum (Reduced Anchor Capacity) <sup>6</sup>			
	Critical Edge or End Distance, $C_{cr}$ (in.)	Allowable Load Reduction Factor	Minimum Edge or End Distance, $C_{min}$ (in.)	Allowable Load Reduction Factor		Critical Spacing, $S_{cr}$ (in.)	Allowable Load Reduction Factor	Minimum Spacing, $S_{min}$ (in.)	Allowable Load Reduction Factor		
	Load Direction		Load Direction			Load Direction		Load Direction			
	Tension or Shear	Tension or Shear	Tension or Shear	Tension	Shear <sup>10</sup>	Tension or Shear	Tension or Shear	Tension or Shear	Tension	Shear	
3/8	12	1.00	4	1.00	1.00	8	1.00	4	0.74	1.00	
1/2	12	1.00	4	1.00	1.00	8	1.00	4	0.76	0.89	
5/8	12	1.00	4	1.00	0.89	8	1.00	4	0.78	0.77	

1. Edge and end distances ( $C_{cr}$  or  $C_{min}$ ) are the distances measured from anchor centerline to edge or end of CMU masonry wall. Refer to Figure 4 (on the right) for an illustration showing critical and minimum edge and end distances.
2. Anchor spacing ( $S_{cr}$  or  $S_{min}$ ) is the distance measured from centerline to centerline of two anchors.
3. Critical edge and end distances,  $C_{cr}$ , are the least edge distances at which tabulated allowable load of an anchor is achieved where a load reduction factor equals 1.0 (no load reduction).
4. Minimum edge and end distances,  $C_{min}$ , are the least edge distances where an anchor has an allowable load capacity which shall be determined by multiplying the allowable loads assigned to anchors installed at critical edge distance,  $C_{cr}$ , by the load reduction factors shown above.
5. Critical spacing,  $S_{cr}$ , is the least anchor spacing at which tabulated allowable load of an anchor is achieved such that anchor performance is not influenced by adjacent anchors.
6. Minimum spacing,  $S_{min}$ , is the least spacing where an anchors has an allowable load capacity, which shall be determined by multiplying the allowable loads assigned to anchors installed at critical spacing distance,  $S_{cr}$ , by the load reduction factors shown above.
7. Reduction factors are cumulative. Multiple reduction factors for more than one spacing or edge or end distance shall be calculated separately and multiplied.
8. Load reduction factor for anchors loaded in tension or shear with edge distances between critical and minimum shall be obtained by linear interpolation.
9. Load reduction factor for anchors loaded in tension with spacing between critical and minimum shall be obtained by linear interpolation.
10. Perpendicular shear loads act toward the edge or end. Parallel shear loads act parallel to the edge or end (see Figure 3 on p. 61). Perpendicular and parallel shear load reduction factors are cumulative when the anchor is located between the critical minimum edge and end distance.

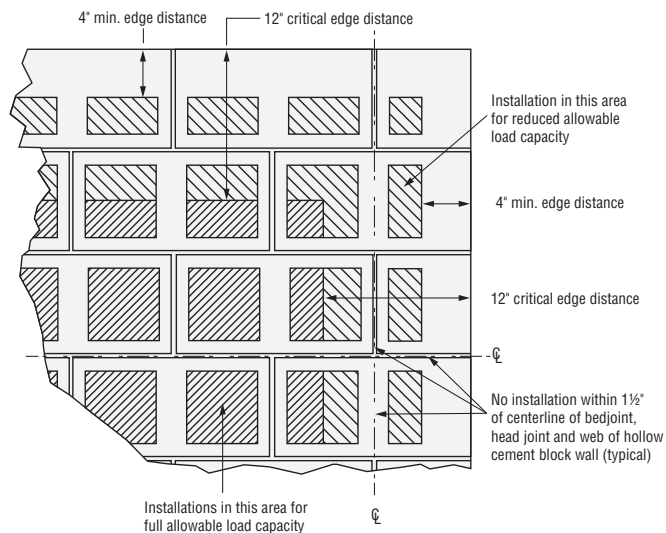

**Figure 4.** Allowable Anchor Locations for Full and Reduced Load Capacity When Installation Is in the Face of Hollow CMU Masonry Wall Construction

\* See p. 12 for an explanation of the load table icons.

# Adhesive Anchoring Installation Instructions



**NOTE:** Always check expiration date on product label. Do not use expired product.

- For best results, adhesive should be conditioned to a temperature between 70°F (21°C) and 80°F (37°C) at the time of installation.
- To warm cold adhesive, store cartridges in a warm, uniformly heated area or storage container. Do not immerse cartridges in water or use microwave to facilitate warming.



**WARNING:** When drilling and cleaning hole, use eye and lung protection. When installing adhesive, use eye and skin protection.

## 1A Hole Preparation – Horizontal, Vertical and Overhead Applications (SET-3G™ for anchor installation)

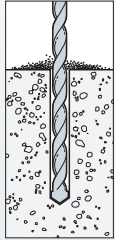

**1. Drill.**  
Drill hole to specified diameter and depth.

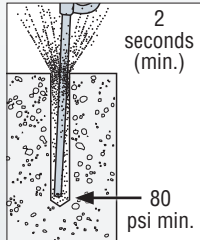

**2. Blow.**  
Remove dust from hole with oil-free compressed air for a minimum of two seconds. Compressed air nozzle must reach the bottom of the hole.

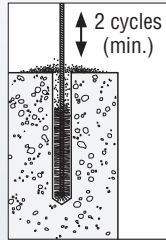

**3. Brush.**  
Clean with a steel wire brush for a minimum of two cycles. Brush should provide resistance to insertion. If no resistance is felt, the brush is worn and must be replaced.

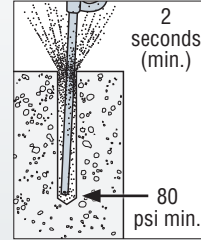

**4. Blow.**  
Remove dust from hole with oil-free compressed air for a minimum of two seconds. Compressed air nozzle must reach the bottom of the hole.

Visit [strongtie.com](http://strongtie.com) for proper brush part number.

## Hole Preparation – Horizontal, Vertical and Overhead Applications (SET-XP®, AT-XP®, ET-HP®) and (SET-3G only for post-installed rebar connections)

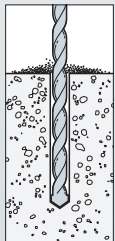

**1. Drill.**  
Drill hole to specified diameter and depth.

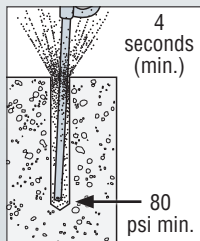

**2. Blow.**  
Remove dust from hole with oil-free compressed air for a minimum of four seconds. Compressed air nozzle must reach the bottom of the hole.

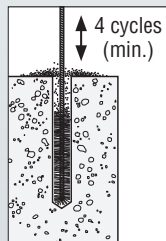

**3. Brush.**  
Clean with a nylon brush for a minimum of four cycles. Brush should provide resistance to insertion. If no resistance is felt, the brush is worn and must be replaced.

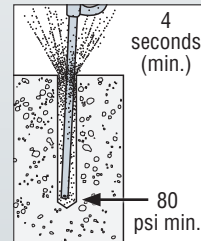

**4. Blow.**  
Remove dust from hole with oil-free compressed air for a minimum of four seconds. Compressed air nozzle must reach the bottom of the hole.

Visit [strongtie.com](http://strongtie.com) for proper brush part number.

## 1B Hole Preparation Vacuum Dust Extraction System with Bosch® / Simpson Strong-Tie® DXS Hollow Carbide Drill Bit – Horizontal, Vertical and Overhead Applications

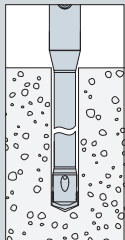

**1. Drill.**  
Drill hole to specified diameter and depth using a Bosch / Simpson Strong-Tie DXS hollow carbide drill bit and vacuum dust extraction system.



**Bosch / Simpson Strong-Tie DXS drill bit used with the vacuum dust extraction system.**

Refer to [strongtie.com](http://strongtie.com) for proper mixing nozzle and dispensing tool part number.

Installation instructions continued on p. 65. →



# Adhesive Anchoring Installation Instructions

## 2 Cartridge Preparation

### 1. Check.

Check expiration date on product label. **Do not use expired product.**

### 2. Open.

Open cartridge per package instructions.

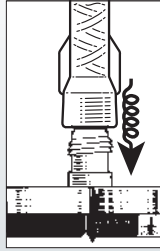

### 3. Attach.

Attach proper Simpson Strong-Tie® nozzle and extension to cartridge. Do not modify nozzle.

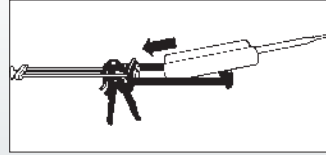

### 4. Insert.

Insert cartridge into dispensing tool.

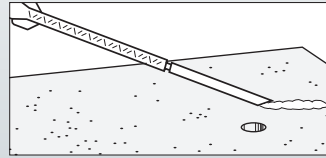

### 5. Dispense.

Dispense adhesive to the side until properly mixed (uniform color).

## FOR SOLID BASE MATERIALS

### 3A Filling the Hole — Vertical Anchorage

Prepare the hole per "Hole Preparation" instructions on product label.

#### Dry and Damp Holes:

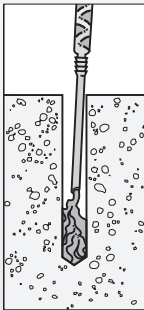

#### 1. Fill.

Fill hole 1/2 to 3/4 full, starting from bottom of hole to prevent air pockets. Withdraw nozzle as hole fills up.

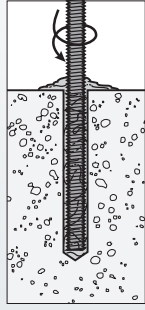

#### 2. Insert.

Insert clean, oil-free anchor, turning slowly until the anchor contacts the bottom of the hole.

*Threaded rod or rebar*

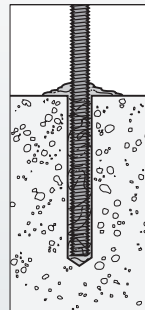

#### 3. Do not disturb.

Do not disturb anchor until fully cured. (See cure schedule for specific adhesive.)

#### Water-Filled Holes:

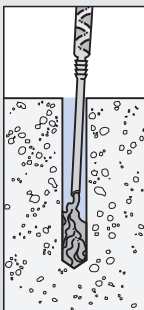

#### 1. Fill.

Fill hole completely full, starting from bottom of hole to prevent water pockets. Withdraw nozzle as hole fills up.

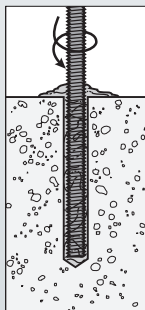

#### 2. Insert.

Insert clean, oil-free anchor, turning slowly until the anchor contacts the bottom of the hole.

*Threaded rod or rebar*

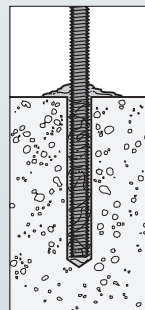

#### 3. Do not disturb.

Do not disturb anchor until fully cured. (See cure schedule.)

**Note:** Nozzle extensions may be needed for deep holes.

# Adhesive Anchoring Installation Instructions

## 3B Filling the Hole — Horizontal and Overhead Anchorage

Prepare the hole per “Hole Preparation” instructions on product label.

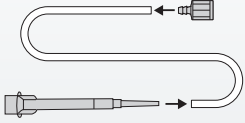

### Step 1:

- Attach the piston plug to one end of the flexible tubing (PPFT25).
- Cut tubing to the length needed for the application, mark tubing as noted below and attach other end of tubing to the mixing nozzle.
- If using a pneumatic dispensing tool, regulate air pressure to 80–100 psi.

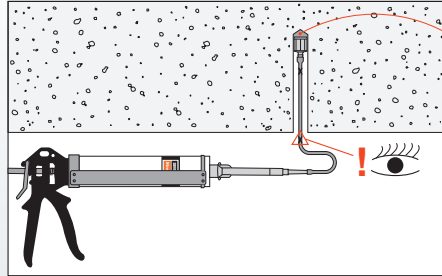
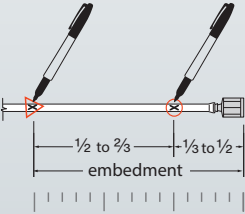

### Step 2:

- Insert the piston plug to the back of the drilled hole and dispense adhesive.

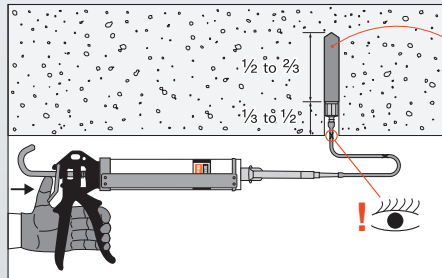

### Step 3:

- Fill the hole  $\frac{1}{2}$  to  $\frac{2}{3}$  full.
- **Note:** As adhesive is dispensed into the drilled hole, the piston plug will slowly displace out of the hole due to back pressure, preventing air gaps.

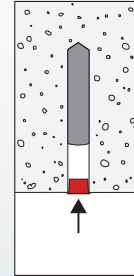

### Step 4:

- Install the appropriate Simpson Strong-Tie adhesive retaining cap.

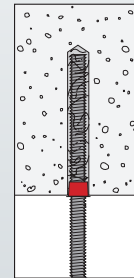

### Step 5:

- Place either threaded rod or rebar through the adhesive retaining cap and into adhesive-filled hole.
- Turn rod/rebar slowly until the insert bottoms out.
- Do not disturb until fully cured.

## FOR HOLLOW BASE MATERIALS

## 3C Filling the Hole — When Anchoring with Screens: For SET-3G™, SET-XP® and AT-XP® Adhesives

Prepare the hole per instructions on “Hole Preparation.”

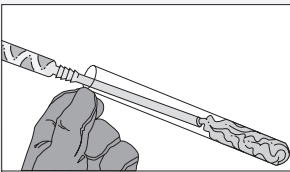

### 1. Fill.

Fill screen completely. Fill from the bottom of the screen and withdraw the nozzle as the screen fills to prevent air pockets. (Close integral cap after filling.)

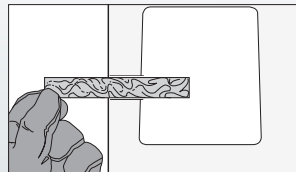

### 2. Insert.

Insert adhesive-filled screen into hole.

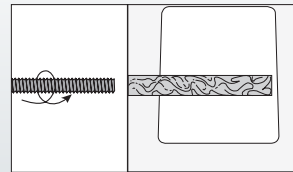

### 3. Insert.

Insert clean, oil-free anchor, turning slowly until the anchor contacts the bottom of the screen.

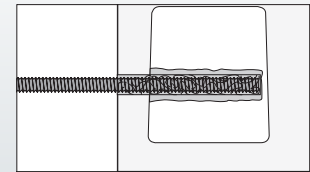

### 4. Do not disturb.

Do not disturb anchor until fully cured. (See cure schedule for specific adhesive.)

# Adhesive Anchoring Installation Instructions

## FOR UNREINFORCED BRICK MASONRY

### 1A Hole Preparation — For Configurations A (Horizontal) and B (22½° Downward) Installations with a Carbide-Tipped Drill Bit.

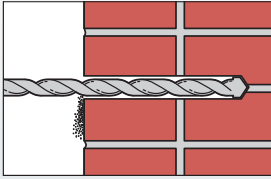

#### 1. Drill.

Drill 1"-diameter hole to specified depth with a carbide-tipped drill bit, using rotation only mode. For Configurations A, drill 8" deep. For Configuration B, drill to within 1" of the opposite side of wall (minimum 13" deep).

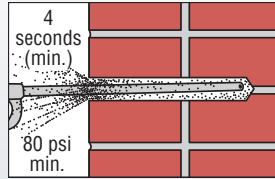

#### 2. Blow.

Remove dust from hole with oil-free compressed air for a minimum of four seconds. Compressed air nozzle MUST reach the bottom of the hole.

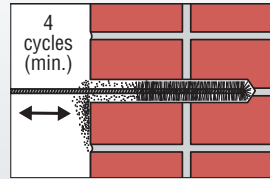

#### 3. Brush.

Clean with a nylon brush for a minimum of four cycles. Brush MUST reach the bottom of the hole. Brush should provide resistance to insertion. If no resistance is felt, the brush is worn and must be replaced.

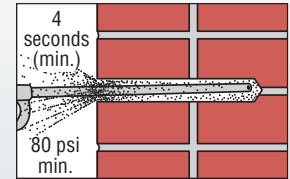

#### 4. Blow.

Remove dust from hole with oil-free compressed air for a minimum of four seconds. Compressed air nozzle MUST reach the bottom of the hole.

## 2 Cartridge Preparation

Reference p. 65 for cartridge preparation.

### 3A Filling the Hole — For Configurations A (Horizontal) and B (22½-Degree Downward) Installations.

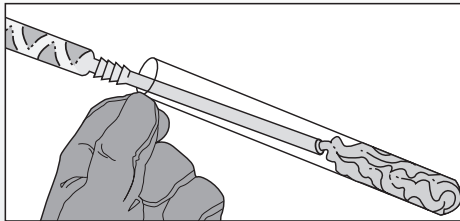

#### 1. Fill.

Fill screen completely. Fill from the bottom of the screen and withdraw the nozzle as the screen fills to prevent air pockets.

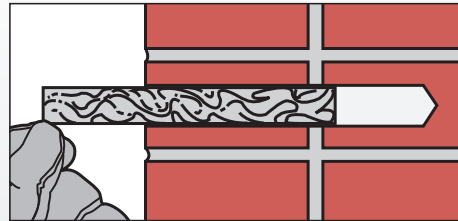

#### 2. Insert.

Insert adhesive filled screen into hole.

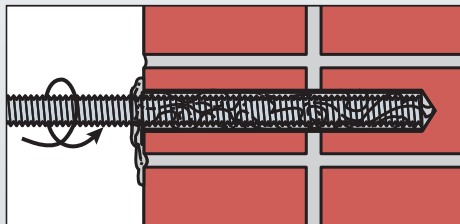

#### 3. Insert.

Insert clean, oil-free anchor, turning slowly until the anchor contacts the bottom of the screen.

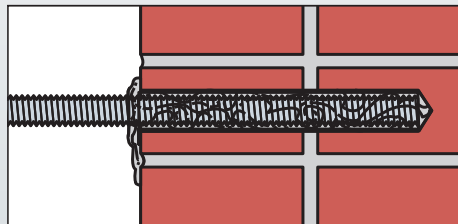

#### 4. Do not disturb.

Do not disturb anchor until fully cured. (See cure schedule for specific adhesive.)

**Note:** Steel wire mesh screens may be used for Configurations A and B.

## Adhesive Accessories

### Hole-Cleaning Brushes

Brushes are used for cleaning drilled holes prior to adhesive installation.

**Note:** The standard hole-cleaning method (blow-brush-blow) can be avoided by using the Speed Clean™ vacuum dust extraction system (DXS) with SET-XP®, AT-XP® and SET-3G™. See p. 236 for details.

#### Wire Brush – Standard

(For use with SET-3G)

Model No.	Hole Diameter (in.)	Anchor Diameter (in.)	Rebar Size	Usable Length (in.)	Carton Quantity
ETB43S	7/16	3/8	—	5	25
ETB50S	1/2	—	#3	5	25
ETB56S	9/16	1/2	—	5	25
ETB62S	5/8	—	#4	5	25
ETB68S	11/16	5/8	—	5	25
ETB75S	3/4	—	#5	5	25
ETB87S	7/8	3/4	#6	5	25
ETB100S	1	7/8	#7	5	25
ETB112S	1 1/8	1	#8	5	25
ETB137S	1 3/8	1 1/4	#10	5	25
ETBS-TH	T-handle			8 1/2	25
ETBS-EXT	Extension			11 1/2	25

1. T-handle is required for use with all sizes of standard wire brush.

2. To obtain total usable length, add the usable length for each part used.



#### Nylon Brush – Standard

(For use with SET-XP, AT-XP and ET-HP®)

Model No.	Hole Diameter (in.)	Anchor Diameter (in.)	Rebar Size	Usable Length (in.)	Carton Quantity
ETB4	3/8 – 7/16	1/4 – 5/16	—	7	24
ETB6	1/2 – 3/4	3/8 – 5/8	#3 – #5	15	24
ETB8	13/16 – 7/8	3/4	#6	15	24
ETB8L	13/16 – 7/8	3/4	#6	23	24
ETB10	1 – 1 1/8	7/8 – 1	#7 – #8	28	24
ETB12	1 3/16 – 1 3/8	1 1/4	#10	33	24

1. All standard nylon brushes are one-piece which includes a twisted wire handle.

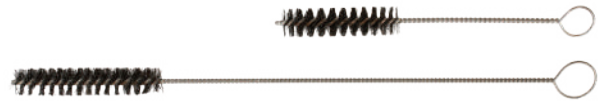

#### Nylon Brush – Rebar

(For use with SET-XP and SET-3G)

**Note:** Brushes are only applicable for SET-3G when used for post-installed rebar connections.)

Model No.	Hole Diameter (in.)	Rebar Size	Usable Length (in.)	Carton Quantity
ETB6R	1/2 – 3/4	#3 – #5	6	25
ETB8R	7/8	#6	6	25
ETB10R	1 – 1 1/8	#7 – #8	8	25
ETB12R	1 3/8	#10	8	25
ETB14R	1 3/4	#11	7	25
ETBR-EXT	T-handle and extension		35 1/4	25

1. ETBR-EXT is required for use with all sizes of rebar nylon brushes.

2. To obtain total usable length, add the usable length for each part used.

3. Brushes are used when rebar is installed to replace cast-in-place bar for lap splices and development length.



## Adhesive Accessories

# Piston Plug Delivery System

The Simpson Strong-Tie® Piston Plug Delivery System for adhesives offers you an easy-to-use, reliable and less time-consuming means to dispense adhesive into drilled holes for threaded rod and rebar dowel installations in overhead, upwardly inclined and horizontal orientations. The matched tolerance design between the piston plug and drilled hole virtually eliminates the formation of voids and air pockets during adhesive dispensing.

The Piston Plug Delivery System consists of three components: piston plug, flexible extension tubing, and adhesive retaining cap.

### Features

- Designed for dispensing adhesive into drilled holes in overhead, upwardly inclined and horizontal orientations, as well as deep embedments
- Suitable for use with all Simpson Strong-Tie anchoring adhesives
- Adhesive piston plugs are sized to fit each drilled hole diameter
- Model number is embossed on each adhesive piston plug for identification
- A barbed end provides a reliable connection to the flexible extension tubing
- Flexible extension tubing is available in 25-foot-long rolls to be cut to required lengths



Use the piston plug delivery system with all Simpson Strong-Tie® adhesive products:



SET-3G™



SET-XP®



AT-XP®



ET-HP®

## Adhesive Accessories

### Piston Plug Delivery System (cont.)

#### Piston Plugs

Model No.	Hole Size (in.)	Pkg. Quantity	Carton Quantity*
PP56-RP10	9/16	10	10 packs of 10
PP62-RP10	5/8	10	10 packs of 10
PP68-RP10	11/16	10	10 packs of 10
PP75-RP10	3/4	10	10 packs of 10
PP81-RP10	13/16	10	10 packs of 10
PP87-RP10	7/8	10	10 packs of 10
PP100-RP10	1	10	10 packs of 10
PP112-RP10	1 1/8	10	10 packs of 10
PP137-RP10	1 3/8	10	10 packs of 10
PP175-RP10	1 3/4	10	10 packs of 10

\*Product is sold by package.



**Piston Plugs**

#### Tubing

Model No.	Description	Package Quantity
PPFT25	Piston Plug Flexible Extension Tubing — 25 ft. roll	1

1. Tubing dimensions: inner diameter 3/8", outer diameter 1/2".



**Piston Plug Flexible Extension Tubing**

### Adhesive Retaining Caps

Adhesive retaining caps make overhead and horizontal installation easier by preventing the adhesive from running out of the hole. They also center the rod in the hole, making them ideal for applications where precise anchor placement is required. It may be necessary to provide support for the anchor during cure time. Adhesive retaining caps are not designed to support the weight of the anchor in overhead installations. Adhesive retaining caps should be used for horizontal and overhead adhesive installations. ARCs may be used in conjunction with the Piston Plug Delivery system.



**Adhesive Retaining Caps**

#### Retaining Caps

Model No.	Hole Size (in.)	Anchor Diameter (in.)	Rebar Size	Cap Depth (in.)	Package Quantity	Carton Quantity* (ea.)
ARC37A-RP25	7/16	3/8	#3	7/16	25	8 packs of 25
ARC37-RP25	1/2	3/8		7/16	25	8 packs of 25
ARC50A-RP25	9/16	1/2	#4	1/2	25	8 packs of 25
ARC50-RP25	5/8	1/2		1/2	25	8 packs of 25
ARC62A-RP25	11/16	5/8	#5	9/16	25	8 packs of 25
ARC62-RP25	3/4	5/8		9/16	25	8 packs of 25
ARC75A-RP25	13/16	3/4	#6	9/16	25	8 packs of 25
ARC75-RP25	7/8	3/4		9/16	25	8 packs of 25
ARC87-RP25	1	7/8	#7	11/16	25	8 packs of 25
ARC100A-RP25	1 1/16	1	#8	11/16	25	8 packs of 25
ARC100-RP25	1 1/8	1		11/16	25	8 packs of 25
ARC125-RP25	1 3/8	1 1/4	#10	7/8	25	8 packs of 25
ARC137-RP25	1 3/4	—	#11	11/16	25	8 packs of 25

\*Product is sold by package.

## Adhesive Accessories

# Opti-Mesh Adhesive-Anchoring Screen Tubes

Screen tubes are vital to the performance of adhesive anchors in base materials that are hollow or contain voids, such as hollow block and brick. The Simpson Strong-Tie® Opti-Mesh screen tube with woven mesh insert provides the advantages of a plastic screen tube while providing superior performance to steel screen tubes and competitive plastic screen tubes.

**Material:** Plastic

 **Caution:** Screen tubes are designed for a specific adhesive type. Epoxy screen tubes must be used with SET-XP®. Acrylic screen tubes must be used with AT-XP®.

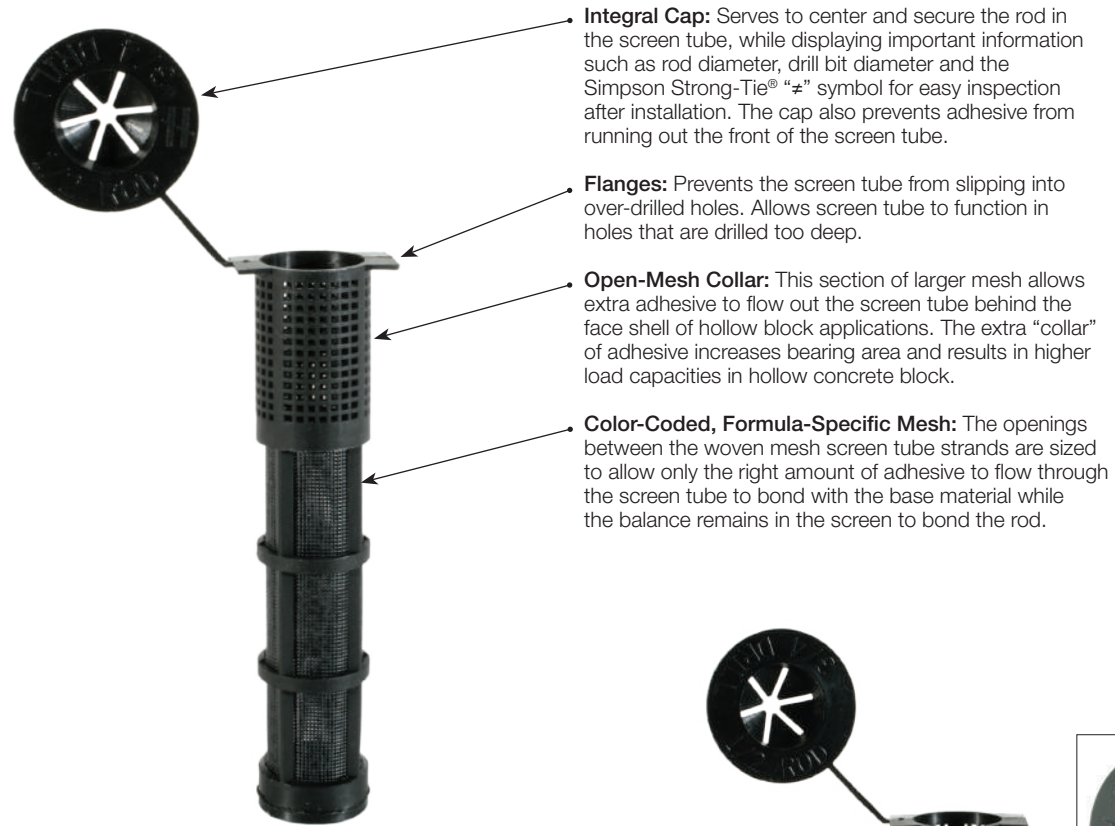

- Integral Cap:** Serves to center and secure the rod in the screen tube, while displaying important information such as rod diameter, drill bit diameter and the Simpson Strong-Tie® “#” symbol for easy inspection after installation. The cap also prevents adhesive from running out the front of the screen tube.
- Flanges:** Prevents the screen tube from slipping into over-drilled holes. Allows screen tube to function in holes that are drilled too deep.
- Open-Mesh Collar:** This section of larger mesh allows extra adhesive to flow out the screen tube behind the face shell of hollow block applications. The extra “collar” of adhesive increases bearing area and results in higher load capacities in hollow concrete block.
- Color-Coded, Formula-Specific Mesh:** The openings between the woven mesh screen tube strands are sized to allow only the right amount of adhesive to flow through the screen tube to bond with the base material while the balance remains in the screen to bond the rod.

**EWSP Epoxy Adhesive Screen Tube**  
(mesh is black)  
For use with SET-XP  
US Patent 6,837,018



The integral cap centers the rod and displays drill bit and rod diameter.



**3GWSP Adhesive Screen Tube**  
(gray frame with gray mesh)  
For use with SET-3G™



**AWSP Acrylic Adhesive Screen Tube**  
(mesh is white)  
For use with AT-XP



## Opti-Mesh Adhesive-Anchoring Screen Tubes (cont.)

### Screen Tubes — Plastic

For Rod Diameter (in.)	Hole Size (in.)	Length (in.)	EWSP Model No. for SET-XP®	AWSP Model No. for AT-XP®	3GWSP Model No. for SET-3G™	Carton Quantity
3/8	9/16	3 1/2	EWS373P	AWS373P	3GWS373P	150
		6	EWS376P	AWS376P	3GWS376P	150
		10	EWS3710P	AWS3710P	3GWS3710P	100
1/2	3/4	3 1/2	EWS503P	AWS503P	3GWS503P	100
		6	EWS506P	AWS506P	3GWS506P	100
		10	EWS5010P	AWS5010P	3GWS5010P	50
5/8	7/8	3 1/2	EWS623P	AWS623P	3GWS623P	50
		6	EWS626P	AWS626P	3GWS626P	50
		10	EWS6210P	AWS6210P	3GWS6210P	25
3/4	1	8	EWS758P	AWS758P	3GWS758P	25
		13	EWS7513P	AWS7513P	3GWS7513P	25

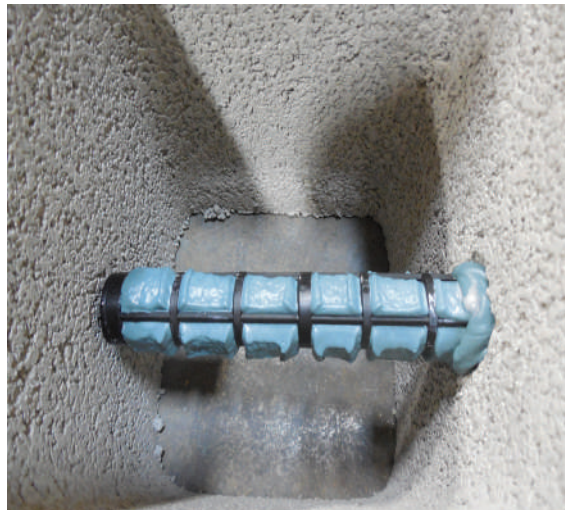

Specially sized holes in Opti-Mesh screens allow for adhesive to seep out at the appropriate location at the hollow portion of the CMU to create a better bond to the face shell.



## Adhesive Accessories

# Steel Adhesive-Anchoring Screen Tubes

Screen tubes are used in hollow base material applications to contain adhesive around the anchor and prevent it from running into voids. Simpson Strong-Tie® screen tubes are specifically designed to work with AT-XP® and ET-HP® adhesives in order to precisely control the amount of adhesive that passes through the mesh. This results in thorough coating and bonding of the rod to the screen tube and base material. Order screen tubes based upon rod diameter and adhesive type. The actual outside diameter of the screen tube is larger than the rod diameter.

**Material:** ATS screen tubes: 50 mesh stainless steel  
ETS screen tubes: 60 mesh carbon steel



**Caution:** Screen tubes are designed for a specific adhesive type. ETS screen tubes must be used with ET-HP formulations and ATS screen tubes must be used with AT-XP.

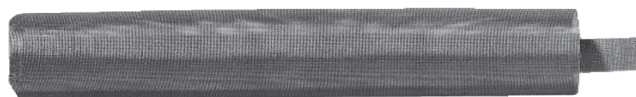

**Screen Tube**

Screen tubes are for use in hollow CMU, hollow brick and unreinforced masonry applications.

### Screen Tubes

For Rod Diameter (in.)	Hole Size (in.)	ATS Stainless Steel Screen Tubes for AT-XP		ETS Carbon Steel Screen Tubes for ET-HP (SET-XP® 3/4" Rod Sizes)		Carton Quantity
		Actual Screen Size O.D./Length (in.)	Model No.	Actual Screen Size O.D./Length (in.)	Model No.	
3/8	9/16	—	—	15/32 x 6	ETS376	150
		—	—	15/32 x 10	ETS3710	100
1/2	1 1/16	—	—	19/32 x 6	ETS506	100
		—	—	19/32 x 10	ETS5010	50
5/8	7/8	—	—	25/32 x 6	ETS626	50
		—	—	25/32 x 10	ETS6210	25
		—	—	25/32 x 13	ETS6213	25
3/4	1	3 1/32 x 8	ATS758	3 1/32 x 8	ETS758	25
		3 1/32 x 13	ATS7513	3 1/32 x 13	ETS7513	25
		3 1/32 x 17	ATS7517	3 1/32 x 17	ETS7517	25
		—	—	3 1/32 x 21	ETS7521	25

## Adhesive Accessories

### Retrofit Bolts

RFBs are pre-cut threaded rod, supplied with nut and washer. Each end of the threaded rod is stamped with the rod length in inches and our No-Equal® symbol for easy identification after installation.

**Material:** ASTM F1554 Grade 36

**Coating:** Zinc-plated, hot-dip galvanized



**RFB  
Retrofit Bolts**

Size. (in.)	Zinc-Plated Model No.	Hot-Dip Galvanized Model No.	Carton Quantity	Hot-Dip Galvanized Retail Model No.*	Package Quantity	Carton Quantity
½ x 4	RFB#4x4	—	50	—	—	—
½ x 5	RFB#4x5	RFB#4x5HDG	50	RFB#4X5HDGP2	2	5 packs of 2
½ x 6	RFB#4x6	RFB#4x6HDG	50	—	—	—
½ x 7	RFB#4x7	RFB#4x7HDG	50	—	—	—
½ x 8	—	RFB#4X8HDG	—	RFB#4X8HDGP2	2	5 packs of 2
½ x 10	RFB#4x10	RFB#4x10HDG	25	—	—	—
⅝ x 5	RFB#5x5	RFB#5x5HDG	50	RFB#5X5HDGP2	2	5 packs of 2
⅝ x 8	RFB#5x8	RFB#5x8HDG	50	RFB#5X8HDGP2	2	5 packs of 2
⅝ x 10	RFB#5x10	RFB#5x10HDG	50	—	—	—
⅝ x 12	—	RFB#5X12HDG	—	RFB#5X12HDGP2	2	5 packs of 2
⅝ x 16	RFB#5x16	RFB#5x16HDG	25	RFB#5X16HDGP2	2	5 packs of 2
¾ x 10½	RFB#6x10.5	RFB#6x10.5HDG	25	—	—	—

\* Retail products packaged in a polybag.

## Adhesive Accessories

### All Thread Rod

ATRs are pre-cut threaded rod for use with Simpson Strong-Tie® adhesives.

**Material:** ASTM F1554 Grade 36, A36 or A307

min  $f_y$  = 36 ksi, min  $F_u$  = 58 ksi and not to exceed 80 ksi

**Coating:** Uncoated, zinc-plated; hot-dip galvanized

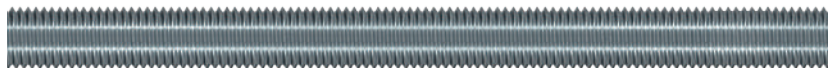

**ATR**  
All Thread Rod

Description Dia. x Length (in.)	Uncoated Model No.	Zinc-Plated Model No.	Hot-Dip Galvanized Model No.	Carton Quantity
3/8 x 12	ATR3/8x12	—	—	1
3/8 x 24	ATR3/8x24	—	—	1
3/8 x 36	ATR3/8x36	—	ATR3/8x36HDG	1
1/2 x 12	ATR1/2x12	ATR1/2x12ZP	ATR1/2x12HDG	1
1/2 x 18	ATR1/2x18	—	ATR1/2x18HDG	1
1/2 x 24	ATR1/2x24	ATR1/2x24ZP	ATR1/2x24HDG	1
1/2 x 36	ATR1/2x36	ATR1/2x36ZP	ATR1/2x36HDG	1
5/8 x 12	ATR5/8x12	ATR5/8x12ZP	ATR5/8x12HDG	1
5/8 x 18	ATR5/8x18	ATR5/8x18ZP	ATR5/8x18HDG	1
5/8 x 24	ATR5/8x24	ATR5/8x24ZP	ATR5/8x24HDG	1
5/8 x 30	ATR5/8x30	—	—	1
5/8 x 36	ATR5/8x36	ATR5/8x36ZP	ATR5/8x36HDG	1
3/4 x 12	ATR3/4x12	ATR3/4x12ZP	ATR3/4x12HDG	1
3/4 x 18	ATR3/4x18	ATR3/4x18ZP	ATR3/4x18HDG	1
3/4 x 24	ATR3/4x24	ATR3/4x24ZP	ATR3/4x24HDG	1
3/4 x 36	ATR3/4x36	ATR3/4x36ZP	ATR3/4x36HDG	1
7/8 x 12	ATR7/8x12	ATR7/8x12ZP	ATR7/8x12HDG	1
7/8 x 18	ATR7/8x18	ATR7/8x18ZP	ATR7/8x18HDG	1
7/8 x 20	ATR7/8x20	—	—	1
7/8 x 24	ATR7/8x24	ATR7/8x24ZP	ATR7/8x24HDG	1
7/8 x 26	ATR7/8x26	—	—	1
7/8 x 36	ATR7/8x36	ATR7/8x36ZP	ATR7/8x36HDG	1
1 x 12	ATR1x12	ATR1x12ZP	ATR1x12HDG	1
1 x 18	ATR1x18	ATR1x18ZP	ATR1x18HDG	1
1 x 24	ATR1x24	ATR1x24ZP	ATR1x24HDG	1
1 x 36	ATR1x36	ATR1x36ZP	ATR1x36HDG	1

# Mechanical Anchors

---

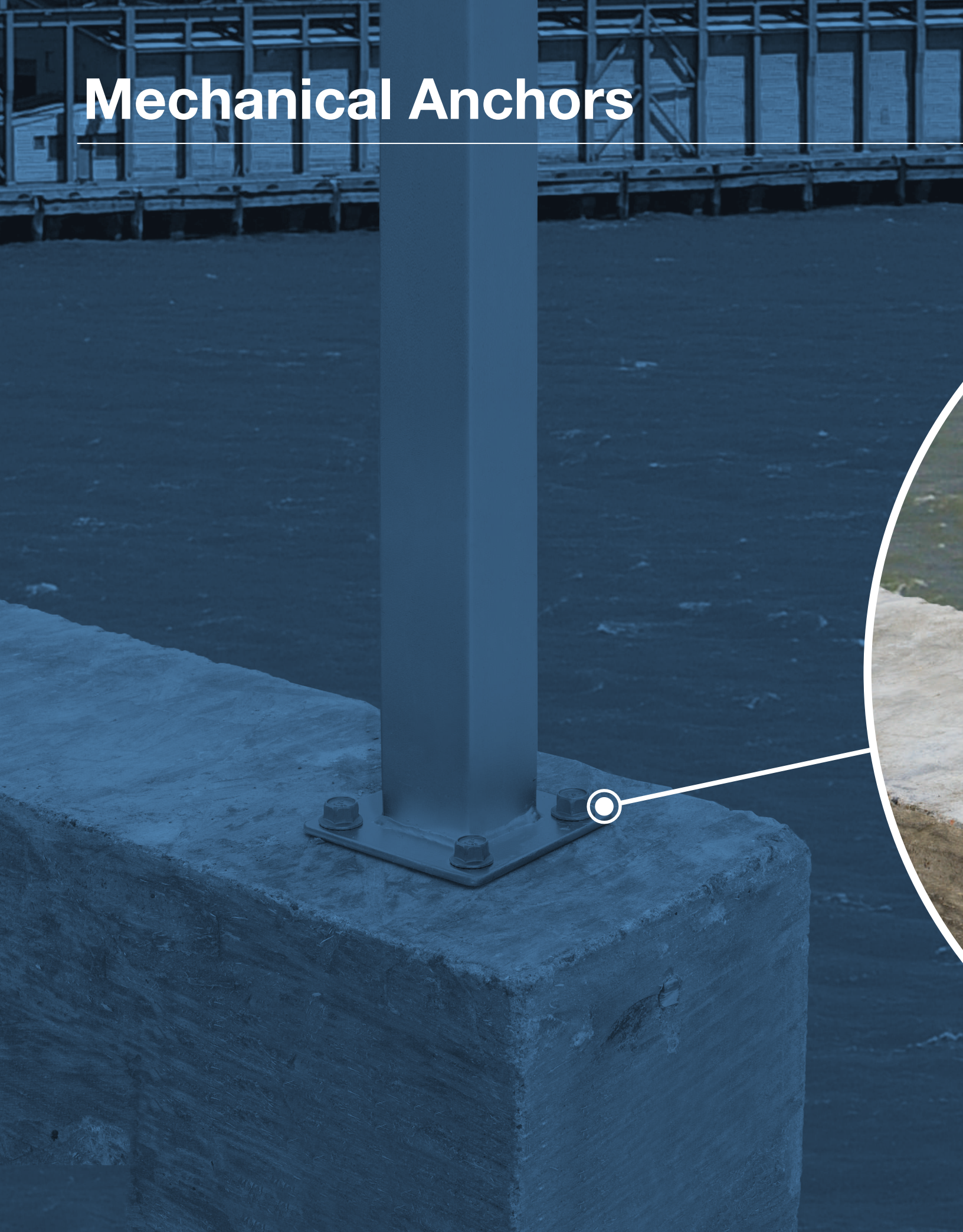



# Titen HD® Heavy-Duty Screw Anchor

A high-strength screw anchor for use in cracked and uncracked concrete, as well as uncracked masonry. The Titen HD offers low installation torque and outstanding performance. Designed for use in dry, interior, non-corrosive environments or temporary outdoor applications.

## Features

- Tested in accordance with ACI 355.2, AC193 and AC106
- Qualified for static and seismic loading conditions
- Thread design undercuts to efficiently transfer the load to the base material
- Standard fractional sizes
- Specialized heat-treating process creates tip hardness for better cutting without compromising the ductility
- No special drill bit required — designed to install using standard-sized ANSI tolerance drill bits
- Hex-washer head requires no separate washer, unless required by code, and provides a clean installed appearance
- Removable — ideal for temporary anchoring (e.g. formwork, bracing) or applications where fixtures may need to be moved
- Reuse of the anchor will not achieve listed loads and is not recommended

**Codes:** ICC-ES ESR-2713 (concrete);

ICC-ES ESR-1056 (masonry);

City of LA Supplement within ESR-2713 (concrete);

City of LA Supplement within ESR-1056 (masonry);

Florida FL15730 (concrete and masonry);

FM 3017082, 3035761 and 3043442;

Multiple DOT listings

**Material:** Carbon steel

**Coating:** Zinc plated or mechanically galvanized.

Not recommended for permanent exterior use or highly corrosive environments.

## Installation

 Holes in steel fixtures to be mounted should match the diameter specified in the table below.

Use a Titen HD screw anchor one time only — installing the anchor multiple times may result in excessive thread wear and reduce load capacity.

 Do not use impact wrenches to install into hollow CMU.

 **Caution:** Oversized holes in base material will reduce or eliminate the mechanical interlock of the threads with the base material and reduce the anchor's load capacity.

1. Drill a hole in the base material using a carbide drill bit the same diameter as the nominal diameter of the anchor to be installed. Drill the hole to the specified embedment depth plus minimum hole depth overdrill (see table below) to allow the thread tapping dust to settle, and blow it clean using compressed air. (Overhead installations need not be blown clean.) Alternatively, drill the hole deep enough to accommodate embedment depth and the dust from drilling and tapping.
2. Insert the anchor through the fixture and into the hole.
3. Tighten the anchor into the base material until the hex-washer head contacts the fixture.

## Additional Installation Information

Titen HD® Diameter (in.)	Wrench Size (in.)	Recommended Steel Fixture Hole Size (in.)	Minimum Hole Depth Overdrill (in.)
1/4	3/8	3/8 to 7/16	1/8
3/8	9/16	1/2 to 9/16	1/4
1/2	3/4	5/8 to 11/16	1/2
5/8	15/16	3/4 to 13/16	1/2
3/4	1 1/8	7/8 to 15/16	1/2

Suggested fixture hole sizes are for structural steel thicker than 12 gauge only. Larger holes are not required for wood or thinner cold-formed steel members.



Serrated teeth on the tip of the Titen HD® screw anchor facilitate cutting and reduce installation torque.

**Titen HD  
Screw Anchor**

## Installation Sequence

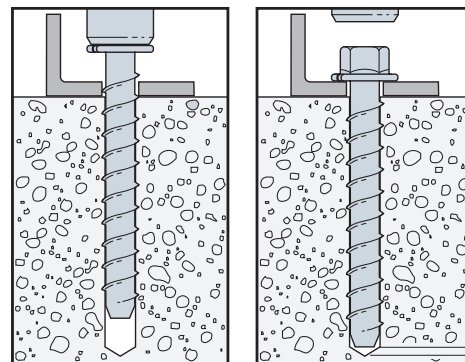
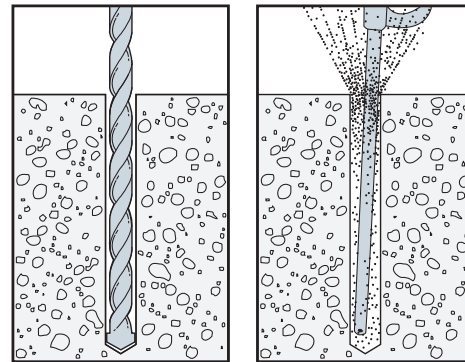

Minimum overdrill. See table.

# Titen HD® Heavy-Duty Screw Anchor

## Countersunk Head Style

The countersunk head style is for applications that require a flush-mount profile. Countersinking also leaves a cleaner surface appearance for exposed through-set applications. The anchor head's 6-lobe drive eases installation and is less prone to stripping than traditional recessed anchor heads.

### Features

- Available in many standard lengths in 1/4" and 3/8" diameters
- Driver bit included in each box

**Codes:** ICC-ES ESR-2713 (concrete);  
ICC-ES ESR-1056 (masonry);

City of LA Supplement within ESR-2713 (concrete);  
City of LA Supplement within ESR-1056 (masonry);  
Florida FL15730 (concrete and masonry)

**Material:** Carbon steel

**Coating:** Zinc plated

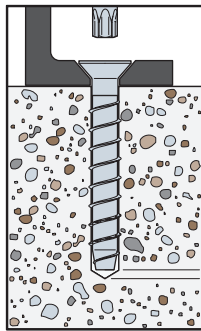

### Additional Installation Information

Titen HD Diameter (in.)	Bit Size	Recommended Steel Fixture Hole Size (in.)	Minimum Hole Depth Overdrill (in.)
1/4	T30	3/8 to 7/16	1/8
3/8	T50	1/2 to 9/16	1/4

Suggested fixture hole sizes are for structural steel thicker than 12 gauge only. Larger holes are not required for wood or thinner cold-formed steel members.

Minimum overdrill.  
See table.



**Titen HD Countersunk Head Style**



**6-lobe drive**

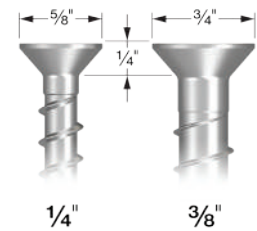

1/4"

3/8"

## Washer-Head Head Style

The washer-head design is commonly used where a minimal head profile is necessary. The model is offered in sizes suitable for use in sill plate applications, and the washer head's low installed profile means modular wall and floor systems can be installed on top with no need for notching the wall framing to accommodate the anchor. The anchor's 6-lobe drive eases driving and is less prone to stripping.

### Features

- Available in many standard lengths in 1/2" and 5/8" diameters
- Driver bit included in each box

**Codes:** ICC-ES ESR-2713 (concrete);  
City of LA Supplement within ESR-2713 (concrete);  
Florida FL15730 (concrete)

**Material:** Carbon steel

**Coating:** Zinc plated

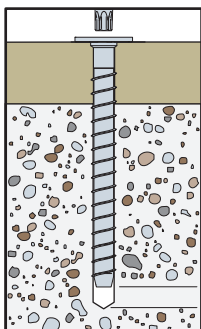

### Additional Installation Information

Titen HD Diameter (in.)	Bit Size	Recommended Steel Fixture Hole Size (in.)	Minimum Hole Depth Overdrill (in.)
1/2	T50	5/8 to 11/16	1/2
5/8	T60	3/4 to 13/16	1/2

Suggested fixture hole sizes are for structural steel thicker than 12 gauge only. Larger holes are not required for wood or thinner cold-formed steel members.

Minimum overdrill.  
See table.



**Titen HD Washer-Head Head Style**



**6-lobe drive**

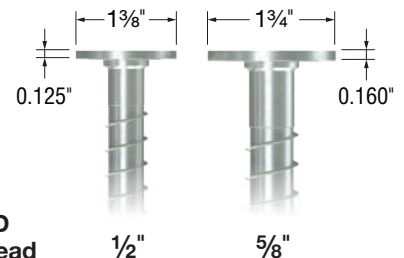

1/2"

5/8"

# Titen HD® Heavy-Duty Screw Anchor

## Titen HD Anchor Product Data — Zinc Plated

Size (in.)	Model No.	Thread Length (in.)	Drill Bit Diameter (in.)	Wrench Size (in.)	Quantity	
					Box	Carton
¼ x 1⅞	THDB25178H	1½	¼	⅜	100	500
¼ x 2¾	THDB25234H	2⅝	¼	⅜	50	250
¼ x 3	THDB25300H	2⅝	¼	⅜	50	250
¼ x 3½	THDB25312H	3⅞	¼	⅜	50	250
¼ x 4	THDB25400H	3⅝	¼	⅜	50	250
⅜ x 1¾	THD37134H†	1¼	⅜	⅞	50	250
⅜ x 2½	THD37212H†	2	⅜	⅞	50	200
⅜ x 3	THD37300H	2½	⅜	⅞	50	200
⅜ x 4	THD37400H	3½	⅜	⅞	50	200
⅜ x 5	THD37500H	4½	⅜	⅞	50	100
⅜ x 6	THD37600H	5½	⅜	⅞	50	100
½ x 3	THD50300H	2½	½	¾	25	100
½ x 4	THD50400H	3½	½	¾	20	80
½ x 5	THD50500H	4½	½	¾	20	80
½ x 6	THD50600H	5½	½	¾	20	80
½ x 6½	THD50612H	5½	½	¾	20	40
½ x 8	THD50800H	5½	½	¾	20	40
½ x 12	THD501200H	5½	½	¾	5	25
½ x 13	THD501300H	5½	½	¾	5	25
½ x 14	THD501400H	5½	½	¾	5	25
½ x 15	THD501500H	5½	½	¾	5	25
⅝ x 4	THDB62400H	3½	⅝	1⅝	10	40
⅝ x 5	THDB62500H	4½	⅝	1⅝	10	40
⅝ x 6	THDB62600H	5½	⅝	1⅝	10	40
⅝ x 6½	THDB62612H	5½	⅝	1⅝	10	40
⅝ x 8	THDB62800H	5½	⅝	1⅝	10	20
⅝ x 10	THDB62100H	5½	⅝	1⅝	10	20
¾ x 4	THD75400H	3½	¾	1⅞	10	40
¾ x 5	THD75500H	4½	¾	1⅞	5	20
¾ x 6	THDT75600H	4½	¾	1⅞	5	20
¾ x 7	THD75700H	5½	¾	1⅞	5	10
¾ x 8½	THD75812H	5½	¾	1⅞	5	10
¾ x 10	THD75100H	5½	¾	1⅞	5	10









† These models do not meet minimum embedment depth requirements for strength design and require maximum installation torque of 25 ft. – lb. using a torque wrench, driver drill or cordless ¼" impact driver with a maximum permitted torque rating of 100 ft. – lb.

1. Length of anchor is measured from underside of head to end of anchor.



## Titen HD® Heavy-Duty Screw Anchor





## Titen HD Anchor Product Data — Countersunk — Zinc Plated

Size (in.)	Model No.	Thread Length (in.)	Drill Bit Diameter (in.)	Wrench Size (in.)	Quantity	
					Box	Carton
 ¼ x 1 7/8	THDB25178CS	1 ½	¼	T30	100	500
 ¼ x 2 ¾	THDB25234CS	2 ¾	¼	T30	50	250
 ¼ x 3 ½	THDB25312CS	3 ¾	¼	T30	50	250
 ¼ x 4 ½	THDB25412CS	4 ¾	¼	T30	50	250
 ¾ x 2 ½	THD37212CS†	2	¾	T50	50	200
 ¾ x 3	THD37300CS	2 ½	¾	T50	50	200
 ¾ x 4	THD37400CS	3 ½	¾	T50	50	200
 ¾ x 5	THD37500CS	4 ½	¾	T50	50	100

† This model does not meet minimum embedment depth requirements for strength design and require maximum installation torque of 25 ft. – lb. using a torque wrench, driver drill or cordless ¼" impact driver with a maximum permitted torque rating of 100 ft. – lb.

1. Length of anchor is measured from top of head to bottom of anchor.

## Titen HD Anchor Product Data — Washer Head — Zinc Plated

Size (in.)	Model No.	Thread Length (in.)	Drill Bit Diameter (in.)	Bit Size	Quantity	
					Box	Carton
 ½ x 6	THD50600WH	5 ½	½	T50	15	60
 ½ x 8	THD50800WH	5 ½	½	T50	15	30
 ¾ x 6	THDB62600WH	5 ½	¾	T60	10	40
 ¾ x 8	THDB62800WH	5 ½	¾	T60	10	20
 ¾ x 10	THDB62100WH	5 ½	¾	T60	10	20

1. Length of anchor is measured from top of head to bottom of anchor.

# Titen HD® Heavy-Duty Screw Anchor

Mechanical Anchors

## Titen HD Anchor Product Data — Mechanically Galvanized

Size (in.)	Model No.	Thread Length (in.)	Drill Bit Diameter (in.)	Wrench Size (in.)	Quantity	
					Box	Carton
3/8 x 3	THD37300HMG	2 1/2	3/8	9/16	50	200
3/8 x 4	THD37400HMG	3 1/2			50	200
3/8 x 5	THD37500HMG	4 1/2			50	100
3/8 x 6	THD37600HMG	5 1/2			50	100
1/2 x 4	THD50400HMG	3 1/2	1/2	3/4	20	80
1/2 x 5	THD50500HMG	4 1/2			20	80
1/2 x 6	THD50600HMG	5 1/2			20	80
1/2 x 6 1/2	THD50612HMG	5 1/2			20	40
1/2 x 8	THD50800HMG	5 1/2			20	40
1/2 x 12	THD501200HMG	5 1/2			5	20
5/8 x 5	THDB62500HMG	4 1/2	5/8	1 5/16	10	40
5/8 x 6	THDB62600HMG	5 1/2			10	40
5/8 x 6 1/2	THDB62612HMG	5 1/2			10	40
5/8 x 8	THDB62800HMG	5 1/2			10	20
3/4 x 5	THD75500HMG	4 1/2	3/4	1 1/8	5	20
3/4 x 6	THDT75600HMG	4 1/2			5	20
3/4 x 8 1/2	THD75812HMG	5 1/2			5	10
3/4 x 10	THD75100HMG	5 1/2			5	10

Mechanical galvanizing meets ASTM B695, Class 65, Type 1. Intended for some pressure-treated wood sill plate applications. Not for use in other corrosive or outdoor environments. See p. 261 or visit [strongtie.com/info](http://strongtie.com/info) for more corrosion information.

## Titen HD Installation Information and Additional Data<sup>1</sup>



Characteristic	Symbol	Units	Nominal Anchor Diameter, d <sub>a</sub> (in.)											
			1/4		3/8		1/2		5/8		3/4			
<b>Installation Information</b>														
Drill Bit Diameter	<i>d<sub>bit</sub></i>	in.	1/4		3/8		1/2		5/8		3/4			
Baseplate Clearance Hole Diameter	<i>d<sub>c</sub></i>	in.	3/8		1/2		5/8		3/4		7/8			
Maximum Installation Torque	<i>T<sub>inst,max</sub></i>	ft.-lbf	24 <sup>2</sup>		50 <sup>2</sup>		65 <sup>2</sup>		100 <sup>2</sup>		150 <sup>2</sup>			
Maximum Impact Wrench Torque Rating	<i>T<sub>impact,max</sub></i>	ft.-lbf	125 <sup>3</sup>		150 <sup>3</sup>		340 <sup>3</sup>		340 <sup>3</sup>		385 <sup>3</sup>			
Minimum Hole Depth	<i>h<sub>hole</sub></i>	in.	1 3/4	2 5/8	2 3/4	3 1/2	3 3/4	4 1/2	4 1/2	6	4 1/2	6	6 3/4	
Nominal Embedment Depth	<i>h<sub>nom</sub></i>	in.	1 5/8	2 1/2	2 1/2	3 1/4	3 1/4	4	4	5 1/2	4	5 1/2	6 1/4	
Critical Edge Distance	<i>c<sub>ac</sub></i>	in.	3	6	2 1/16	3 5/8	3 9/16	4 1/2	4 1/2	6 3/8	6	6 3/8	7 5/16	
Minimum Edge Distance	<i>c<sub>min</sub></i>	in.	1 1/2				1 3/4							
Minimum Spacing	<i>s<sub>min</sub></i>	in.	1 1/2				3					2 3/4	3	
Minimum Concrete Thickness	<i>h<sub>min</sub></i>	in.	3 1/4	3 1/2	4	5	5	6 1/4	6	8 1/2	6	8 3/4	10	
<b>Additional Data</b>														
Anchor Category	Category	—	1											
Yield Strength	<i>f<sub>ya</sub></i>	psi	100,000				97,000							
Tensile Strength	<i>f<sub>uta</sub></i>	psi	125,000				110,000							
Minimum Tensile and Shear Stress Area	<i>A<sub>se</sub></i>	in <sup>2</sup>	0.042		0.099		0.183		0.276		0.414			
Axial Stiffness in Service Load Range — Uncracked Concrete	<i>β<sub>un-cr</sub></i>	lb./in.	202,000				672,000							
Axial Stiffness in Service Load Range — Cracked Concrete	<i>β<sub>cr</sub></i>	lb./in.	173,000				345,000							

- The information presented in this table is to be used in conjunction with the design criteria of ACI 318-14 Chapter 17 and ACI 318-11 Appendix D.
- T<sub>inst,max</sub>* is the maximum permitted installation torque for the embedment depth range covered by this table using a torque wrench.
- T<sub>impact,max</sub>* is the maximum permitted torque rating for impact wrenches for the embedment depth range covered by this table.

\* See p. 12 for an explanation of the load table icons.

# Titen HD® Design Information — Concrete



## Titen HD Tension Strength Design Data<sup>1</sup>

Characteristic	Symbol	Units	Nominal Anchor Diameter, d <sub>a</sub> (in.)											
			¼		⅜		½		⅝		¾			
Nominal Embedment Depth	<i>h<sub>nom</sub></i>	in.	1½	2½	2½	3¼	3¼	4	4	5½	4	5½	6¼	
<b>Steel Strength in Tension — ACI 318-14 Section 17.4.1 or ACI 318-11 Section D.5.1</b>														
Tension Resistance of Steel	<i>N<sub>sa</sub></i>	lb.	5,195		10,890		20,130		30,360		45,540			
Strength Reduction Factor — Steel Failure	<i>φ<sub>sa</sub></i>	—	0.65 <sup>2</sup>											
<b>Concrete Breakout Strength in Tension<sup>6</sup> — ACI 318-14 Section 17.4.2 or ACI 318-11 Section D.5.2</b>														
Effective Embedment Depth	<i>h<sub>ef</sub></i>	in.	1.19	1.94	1.77	2.40	2.35	2.99	2.97	4.24	2.94	4.22	4.86	
Critical Edge Distance <sup>6</sup>	<i>c<sub>ac</sub></i>	in.	3	6	2 <sup>11</sup> / <sub>16</sub>	3⅝	3 <sup>9</sup> / <sub>16</sub>	4½	4½	6⅝	6	6⅝	7 <sup>5</sup> / <sub>16</sub>	
Effectiveness Factor — Uncracked Concrete	<i>k<sub>uncr</sub></i>	—	30		24						27		24	
Effectiveness Factor — Cracked Concrete	<i>k<sub>cr</sub></i>	—	17											
Modification Factor	<i>ψ<sub>c,N</sub></i>	—	1.0											
Strength Reduction Factor — Concrete Breakout Failure	<i>φ<sub>cb</sub></i>	—	0.65 <sup>7</sup>											
<b>Pullout Strength in Tension — ACI 318-14 Section 17.4.3 or ACI 318-11 Section D.5.3</b>														
Pullout Resistance, Uncracked Concrete (f' <sub>c</sub> = 2,500 psi)	<i>N<sub>p,uncr</sub></i>	lb.	— <sup>3</sup>	— <sup>3</sup>	2,700 <sup>4</sup>	— <sup>3</sup>	— <sup>3</sup>	— <sup>3</sup>	— <sup>3</sup>	9,810 <sup>4</sup>	— <sup>3</sup>	— <sup>3</sup>	— <sup>3</sup>	
Pullout Resistance, Cracked Concrete (f' <sub>c</sub> = 2,500 psi)	<i>N<sub>p,cr</sub></i>	lb.	— <sup>3</sup>	1,905 <sup>4</sup>	1,235 <sup>4</sup>	2,700 <sup>4</sup>	— <sup>3</sup>	— <sup>3</sup>	3,040 <sup>4</sup>	5,570 <sup>4</sup>	— <sup>3</sup>	6,070 <sup>4</sup>	7,195 <sup>4</sup>	
Strength Reduction Factor — Concrete Pullout Failure	<i>φ<sub>p</sub></i>	—	0.65 <sup>5</sup>											
<b>Tension Strength for Seismic Applications — ACI 318-14 Section 17.4.2.3.3 or ACI 318-11 Section D.3.3.3</b>														
Nominal Pullout Strength for Seismic Loads (f' <sub>c</sub> = 2,500 psi)	<i>N<sub>p,eq</sub></i>	lb.	— <sup>3</sup>	1,905 <sup>4</sup>	1,235 <sup>4</sup>	2,700 <sup>4</sup>	— <sup>3</sup>	— <sup>3</sup>	3,040 <sup>4</sup>	5,570 <sup>4</sup>	3,840 <sup>4</sup>	6,070 <sup>4</sup>	7,195 <sup>4</sup>	
Strength Reduction Factor — Breakout or Pullout Failure	<i>φ<sub>eq</sub></i>	—	0.65 <sup>5</sup>											

- The information presented in this table is to be used in conjunction with the design criteria of ACI 318-14 Chapter 17 and ACI 318-11 Appendix D, except as modified below.
- The tabulated value of *φ<sub>sa</sub>* applies when the load combinations of Section 1605.2.1 of the IBC, ACI 318-14 Section 5.3 or ACI 318-11 Section 9.2 are used. If the load combinations of ACI 318-11 Appendix C are used, the appropriate value of *φ<sub>sa</sub>* must be determined in accordance with ACI 318-11 D.4.4. Anchors are considered brittle steel elements.
- Pullout strength is not reported since concrete breakout controls.
- Adjust the characteristic pullout resistance for other concrete compressive strengths by multiplying the tabular value by (f'<sub>c,specified</sub> / 2,500)<sup>0.5</sup>.
- The tabulated value of *φ<sub>p</sub>* or *φ<sub>eq</sub>* applies when the load combinations of Section 1605.2.1 of the IBC, ACI 318-14 Section 5.3 or ACI 318-11 Section 9.2 are used and the requirements of ACI 318-14 17.3.3(c) or ACI 318-11 D.4.3(c) for Condition B are met. If the load combinations of ACI 318-11 Appendix C are used, appropriate value of *φ* must be determined in accordance with ACI 318-11 Section D.4.4(c).
- The modification factor *ψ<sub>cp,N</sub>* = 1.0 for cracked concrete. Otherwise, the modification factor for uncracked concrete without supplementary reinforcement to control splitting is either:  
 (1) *ψ<sub>cp,N</sub>* = 1.0 if *c<sub>a,min</sub>* ≥ *c<sub>ac</sub>* or (2) *ψ<sub>cp,N</sub>* =  $\frac{c_{a,min}}{c_{ac}} \geq \frac{1.5h_{ef}}{c_{ac}}$  if *c<sub>a,min</sub>* < *c<sub>ac</sub>*  
 The modification factor, *ψ<sub>cp,N</sub>* is applied to the nominal concrete breakout strength, *N<sub>cb</sub>* or *N<sub>cbg</sub>*.
- The tabulated value of *φ<sub>cb</sub>* applies when both the load combinations of Section 1605.2.1 of the IBC, ACI 318-14 Section 5.3 or ACI 318-11 Section 9.2 are used and the requirements of ACI 318-14 17.3.3(c) or ACI 318-11 D.4.3(c) for Condition B are met. Condition B applies where supplementary reinforcement is not provided. For installations where complying supplementary reinforcement can be verified, the *φ<sub>cb</sub>* factors described in ACI 318-14 17.3.3(c) or ACI 318-11 D.4.3(c) for Condition A are allowed. If the load combinations of ACI 318-11 Appendix C are used, the appropriate value of *φ<sub>cb</sub>* must be determined in accordance with ACI 318-11 D.4.4(c).

C-A-2021 © 2021 SIMPSON STRONG-TIE COMPANY INC.

Mechanical Anchors

\* See p. 12 for an explanation of the load table icons.

# Titen HD® Design Information — Concrete

## Titen HD Shear Strength Design Data<sup>1</sup>

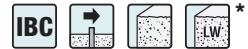

Characteristic	Symbol	Unit	Nominal Anchor Diameter, d <sub>a</sub> (in.)											
			1/4		3/8		1/2		5/8		3/4			
Nominal Embedment Depth	<i>h<sub>nom</sub></i>	in.	1 5/8	2 1/2	2 1/2	3 1/4	3 1/4	4	4	5 1/2	4	5 1/2	6 1/4	
<b>Steel Strength in Shear</b>														
Shear Resistance of Steel	<i>V<sub>sa</sub></i>	lb.	2,020		4,460		7,455		10,000		14,950		16,840	
Strength Reduction Factor — Steel Failure	$\phi_{sa}$	—	0.60 <sup>2</sup>											
<b>Concrete Breakout Strength in Shear</b>														
Outside Diameter	<i>d<sub>a</sub></i>	in.	0.25		0.375		0.500		0.625		0.750			
Load Bearing Length of Anchor in Shear	<i>ℓ<sub>e</sub></i>	in.	1.19	1.94	1.77	2.40	2.35	2.99	2.97	4.24	2.94	4.22	4.86	
Strength Reduction Factor — Concrete Breakout Failure	$\phi_{cb}$	—	0.70 <sup>3</sup>											
<b>Concrete Pryout Strength in Shear</b>														
Coefficient for Pryout Strength	<i>k<sub>cp</sub></i>	lb.	1.0						2.0					
Strength Reduction Factor — Concrete Pryout Failure	$\phi_{cp}$	—	0.70 <sup>4</sup>											
<b>Steel Strength in Shear for Seismic Applications</b>														
Shear Resistance for Seismic Loads	<i>V<sub>eq</sub></i>	lb.	1,695		2,855		4,790		8,000		9,350			
Strength Reduction Factor — Steel Failure	$\phi_{eq}$	—	0.60 <sup>2</sup>											

- The information presented in this table is to be used in conjunction with the design criteria of ACI 318-14 Chapter 17 and ACI 318-11 Appendix D, except as modified below.
- The tabulated value of  $\phi_{sa}$  and  $\phi_{eq}$  applies when the load combinations of Section 1605.2.1 of the IBC, ACI 318-14 Section 5.3 or ACI 318-11 Section 9.2 are used. If the load combinations of ACI 318-11 Appendix C are used, the appropriate value of  $\phi_{sa}$  and  $\phi_{eq}$  must be determined in accordance with ACI 318 D.4.4.
- The tabulated value of  $\phi_{cb}$  applies when both the load combinations of Section 1605.2.1 of the IBC, ACI 318-14 Section 5.3 or ACI 318-11 Section 9.2 are used and the requirements of ACI 318-14 17.3.3(c) or ACI 318-11 D.4.3(c) for Condition B are met. Condition B applies where supplementary reinforcement is not provided. For installations where complying supplementary reinforcement can be verified, the  $\phi_{cb}$  factors described in ACI 318-14 17.3.3(c) or ACI 318-11 D.4.3(c) for Condition A are allowed. If the load combinations of ACI 318-11 Appendix C are used, the appropriate value of  $\phi_{cb}$  must be determined in accordance with ACI 318-11 D.4.4(c).
- The tabulated value of  $\phi_{cp}$  applies when both the load combinations of IBC Section 1605.2, ACI 318-14 5.3 or ACI 318-11 Section 9.2 are used and the requirements of ACI 318-14 17.3.3(c) or ACI 318-11 D.4.3(c) for Condition B are met. If the load combinations of ACI 318-11 Appendix C are used, appropriate value of  $\phi_{cp}$  must be determined in accordance with ACI 318-11 Section D.4.4(c).

## Titen HD Tension and Shear Strength Design Data for the Soffit of Normal-Weight or Sand-Lightweight Concrete over Steel Deck<sup>1,6,7</sup>



Characteristic	Symbol	Units	Nominal Anchor Diameter, d <sub>a</sub> (in.)									
			Lower Flute						Upper Flute			
			Figure 2		Figure 1				Figure 2		Figure 1	
			1/4	3/8	1/2	5/8	3/4	1/4	3/8	1/2		
Nominal Embedment Depth	<i>h<sub>nom</sub></i>	in.	1 5/8	2 1/2	1 7/8	2 1/2	2	3 1/2	1 5/8	2 1/2	1 7/8	2
Effective Embedment Depth	<i>h<sub>ef</sub></i>	in.	1.19	1.94	1.23	1.77	1.29	2.56	1.19	1.94	1.23	1.29
Pullout Resistance, concrete on steel deck (cracked) <sup>2,3,4</sup>	<i>N<sub>p,deck,cr</sub></i>	lb.	420	535	375	870	905	2,040	655	1,195	500	1,700
Pullout Resistance, concrete on steel deck (uncracked) <sup>2,3,4</sup>	<i>N<sub>p,deck,uncr</sub></i>	lb.	995	1,275	825	1,905	1,295	2,910	1,555	2,850	1,095	2,430
Steel Strength in Shear, concrete on steel deck <sup>5</sup>	<i>V<sub>sa,deck</sub></i>	lb.	1,335	1,745	2,240	2,395	2,435	4,430	2,010	2,420	4,180	7,145
Steel Strength in Shear, Seismic	<i>V<sub>sa,deck,eq</sub></i>	lb.	870	1,135	1,434	1,533	1,565	2,846	1,305	1,575	2,676	4,591

- The information presented in this table is to be used in conjunction with the design criteria of ACI 318-14 Chapter 17 and ACI 318-11 Appendix D, except as modified below.
- Concrete compressive strength shall be 3,000 psi minimum. The characteristic pullout resistance for greater compressive strengths shall be increased by multiplying the tabular value by  $(f'_{c,specified} / 3,000)^{0.5}$ .
- For anchors installed in the soffit of sand-lightweight or normal-weight concrete over steel deck floor and roof assemblies, as shown in Figure 1 and Figure 2, calculation of the concrete breakout strength may be omitted.
- In accordance with ACI 318-14 Section 17.4.3.2 or ACI 318-11 Section D.5.3.2, the nominal pullout strength in cracked concrete for anchors installed in the soffit of sand-lightweight or normal-weight concrete over steel deck floor and roof assemblies *N<sub>p,deck,cr</sub>* shall be substituted for *N<sub>p,cr</sub>*. Where analysis indicates no cracking at service loads, the normal pullout strength in uncracked concrete *N<sub>p,deck,uncr</sub>* shall be substituted for *N<sub>p,uncr</sub>*.
- In accordance with ACI 318-14 Section 17.5.1.2(C) or ACI 318-11 Section D.6.1.2(c), the shear strength for anchors installed in the soffit of sand-lightweight or normal-weight concrete over steel deck floor and roof assemblies *V<sub>sa,deck</sub>* and *V<sub>sa,deck,eq</sub>* shall be substituted for *V<sub>sa</sub>*.
- Minimum edge distance to edge of panel is  $2h_{ef}$ .
- The minimum anchor spacing along the flute must be the greater of  $3h_{ef}$  or 1.5 times the flute width.

\* See p. 12 for an explanation of the load table icons.

# Titen HD® Design Information — Concrete

Titen HD Anchor Tension and Shear Strength Design  
Data in the Topside of Normal-Weight Concrete or  
Sand-Lightweight Concrete over Steel Deck

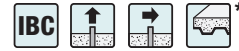

Design Information	Symbol	Units	Nominal Anchor Diameter, $d_a$ (in.)	
			Figure 3	Figure 3
			$\frac{1}{4}$	$\frac{3}{8}$
Nominal Embedment Depth	$h_{nom}$	in.	1½	2½
Effective Embedment Depth	$h_{ef}$	in.	1.19	1.77
Minimum Concrete Thickness	$h_{min,deck}$	in.	2½	3¼
Critical Edge Distance	$c_{ac,deck,top}$	in.	3¾	7¼
Minimum Edge Distance	$c_{min,deck,top}$	in.	3½	3
Minimum Spacing	$s_{min,deck,top}$	in.	3½	3

- For anchors installed in the topside of concrete-filled deck assemblies, as shown in Figures 2 and 3, the nominal concrete breakout strength of a single anchor or group of anchors in shear,  $V_{cb}$  or  $V_{cbg}$ , respectively, must be calculated in accordance with ACI 318-14 Section 17.5.2 or ACI 318-11 Section D.6.2, using the actual member thickness,  $h_{min,deck}$ , in the determination of  $A_{vc}$ .
- Design capacity shall be based on calculations according to values in the tables featured on p. 84.
- Minimum flute depth (distance from top of flute to bottom of flute) is 1½" (see Figures 2 and 3).
- Steel deck thickness shall be minimum 20 gauge.
- Minimum concrete thickness ( $h_{min,deck}$ ) refers to concrete thickness above upper flute (see Figures 2 and 3).

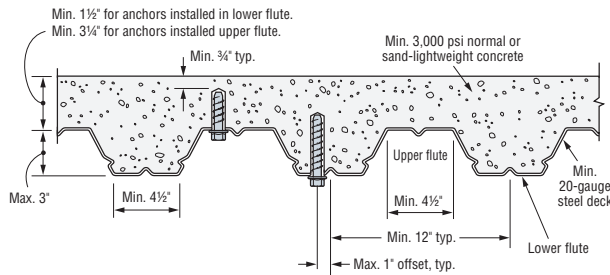

**Figure 1.** Installation of  $\frac{3}{8}$ "- and  $\frac{1}{2}$ "-Diameter Anchors in the Soffit of Concrete over Steel Deck

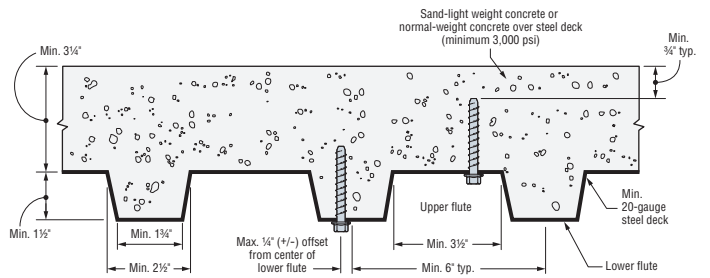

**Figure 2.** Installation of  $\frac{1}{4}$ "-Diameter Anchors in the Soffit of Concrete over Steel Deck

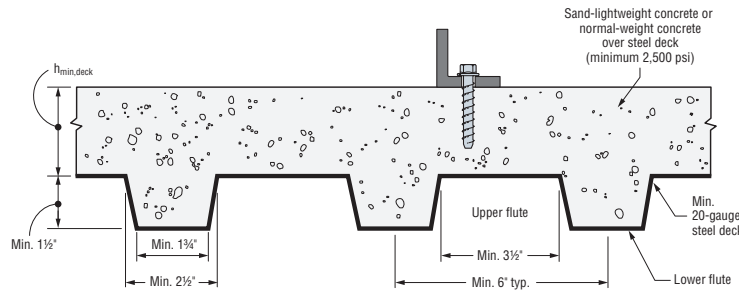

**Figure 3.** Installation of  $\frac{1}{4}$ "- and  $\frac{3}{8}$ "-Diameter Anchors in the Topside of Concrete over Steel Deck

C-A-2021 © 2021 SIMPSON STRONG-TIE COMPANY INC.

\* See p. 12 for an explanation of the load table icons.

# Titen HD® Design Information — Masonry

Titen HD Allowable Tension and Shear Loads in  
8" Lightweight, Medium-Weight and Normal-Weight Grout-Filled CMU

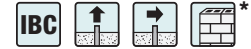

Mechanical Anchors

Size in. (mm)	Drill Bit Diameter in.	Minimum Embedment Depth in. (mm)	Critical Edge Distance $C_{crit}$ in. (mm)	Minimum Edge Distance $C_{min}$ in. (mm)	Critical Spacing Distance in. (mm)	Values for 8" Lightweight, Medium-Weight or Normal-Weight Grout-Filled CMU			
						Tension Load		Shear Load	
						Ultimate lb. (kN)	Allowable lb. (kN)	Ultimate lb. (kN)	Allowable lb. (kN)
<b>Anchor Installed in the Face of the CMU Wall (See Figure 4)</b>									
1/4 (6.4)	1/4	2 1/2 (64)	4 (102)	1 1/4 (32)	4 (102)	2,050 (9.1)	410 (1.8)	2,500 (11.1)	500 (2.2)
3/8 (9.5)	3/8	2 3/4 (70)	12 (305)	4 (102)	6 (152)	2,390 (10.6)	480 (2.1)	4,340 (19.3)	870 (3.9)
1/2 (12.7)	1/2	3 1/2 (89)	12 (305)	4 (102)	8 (203)	3,440 (15.3)	690 (3.1)	6,920 (30.8)	1,385 (6.2)
5/8 (15.9)	5/8	4 1/2 (114)	12 (305)	4 (102)	10 (254)	5,300 (23.6)	1,060 (4.7)	10,420 (46.4)	2,085 (9.3)
3/4 (19.1)	3/4	5 1/2 (140)	12 (305)	4 (102)	12 (305)	7,990 (35.5)	1,600 (7.1)	15,000 (66.7)	3,000 (13.3)

1. The tabulated allowable loads are based on a safety factor of 5.0 for installations under the IBC and IRC.
2. Values for 8"-wide, lightweight, medium-weight and normal-weight concrete masonry units.
3. The masonry units must be fully grouted.
4. The minimum specified compressive strength of masonry,  $f_m$ , at 28 days is 1,500 psi.
5. Embedment depth is measured from the outside face of the concrete masonry unit.
6. Grout-filled CMU wall design must satisfy applicable design standards and be capable of withstanding applied loads.
7. Refer to allowable load-adjustment factors for spacing and edge distance on pp. 90–91.

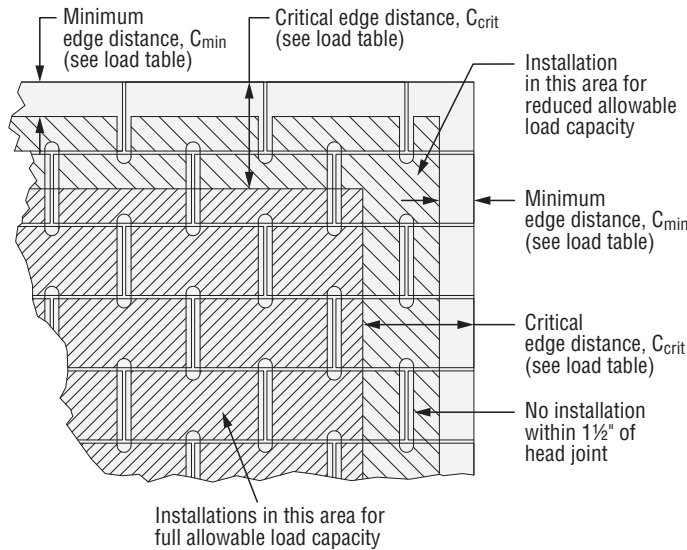

**Figure 4.** Shaded Area = Placement for Full and Reduced Allowable Load Capacity in Grout-Filled CMU

# Titen HD® Design Information — Masonry

Titen HD Allowable Tension and Shear Loads in  
8" Lightweight, Medium-Weight and Normal-Weight Hollow CMU



Size in. (mm)	Drill Bit Diameter in.	Embedment Depth <sup>4</sup> in. (mm)	Minimum Edge Distance in. (mm)	8" Hollow CMU Loads Based on CMU Strength			
				Tension Load		Shear Load	
				Ultimate lb. (kN)	Allowable lb. (kN)	Ultimate lb. (kN)	Allowable lb. (kN)
<b>Anchor Installed in Face Shell (See Figure 5)</b>							
3/8 (9.5)	3/8	1 3/4 (45)	4 (102)	720 (3.2)	145 (0.6)	1,240 (5.5)	250 (1.1)
1/2 (12.7)	1/2	1 3/4 (45)	4 (102)	760 (3.4)	150 (0.7)	1,240 (5.5)	250 (1.1)
5/8 (15.9)	5/8	1 3/4 (45)	4 (102)	800 (3.6)	160 (0.7)	1,240 (5.5)	250 (1.1)
3/4 (19.1)	3/4	1 3/4 (45)	4 (102)	880 (3.9)	175 (0.8)	1,240 (5.5)	250 (1.1)

- The tabulated allowable loads are based on a safety factor of 5.0 for installations under the IBC and IRC.  
**Note:** No installation within 4 5/8" of bed joint of hollow masonry block wall.
- Values for 8"-wide, lightweight, medium-weight and normal-weight concrete masonry units.
- The minimum specified compressive strength of masonry,  $f_m$ , at 28 days is 1,500 psi.
- Embedment depth is measured from the outside face of the concrete masonry unit and is based on the anchor being embedded an additional 1/2"- through 1 1/4"-thick face shell.
- Allowable loads may not be increased for short-term loading due to wind or seismic forces.  
CMU wall design must satisfy applicable design standards and be capable of withstanding applied loads.
- Do not use impact wrenches to install in hollow CMU.
- Set drill to rotation-only mode when drilling into hollow CMU.
- The tabulated allowable loads are based on one anchor installed in a single cell.
- Distance from centerline of anchor to head joint shall be a minimum of 4 5/8".

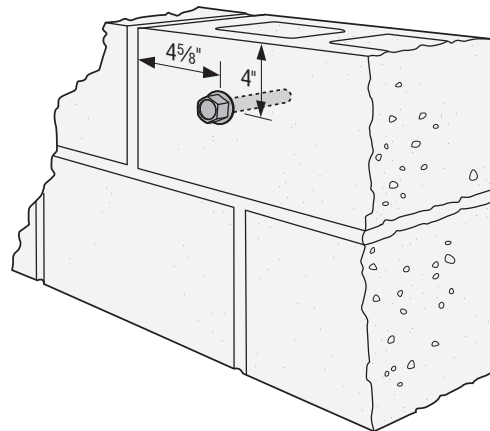
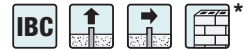

Figure 5

\* See p. 12 for an explanation of the load table icons.

# Titen HD® Design Information — Masonry

## Titen HD® Allowable Tension and Shear Loads in 8" Lightweight, Medium-Weight and Normal-Weight Grout-Filled CMU Stemwall



Size in. (mm)	Drill Bit Diameter in.	Embed. Depth in. (mm)	Minimum Edge Distance in. (mm)	Minimum End Distance in. (mm)	Critical Spacing Distance in. (mm)	8" Grout-Filled CMU Allowable Loads Based on CMU Strength, $f'_m = 1,500$ psi					
						Tension		Shear Perpendicular to Edge		Shear Parallel to Edge	
						Ultimate lb. (kN)	Allowable lb. (kN)	Ultimate lb. (kN)	Allowable lb. (kN)	Ultimate lb. (kN)	Allowable lb. (kN)
<b>Anchor Installed in Cell Opening or Web (Top of Wall) (See Figure 6)</b>											
1/2 (12.7)	1/2	4 1/2 (114)	1 3/4 (45)	8 (203)	8 (203)	2,860 (12.7)	570 (2.5)	800 (3.6)	160 (0.7)	2,920 (13.0)	585 (2.6)
5/8 (15.9)	5/8	4 1/2 (114)	1 3/4 (45)	10 (254)	10 (254)	2,860 (12.7)	570 (2.5)	800 (3.6)	160 (0.7)	3,380 (15.0)	675 (3.0)

1. The tabulated allowable loads are based on a safety factor of 5.0 for installations under the IBC and IRC.
2. Values are for 8"-wide, lightweight, medium-weight and normal-weight concrete masonry units.
3. The masonry units must be fully grouted.
4. The minimum specified compressive strength of masonry,  $f'_m$ , at 28 days is 1,500 psi.
5. Grout-filled CMU wall design must satisfy applicable design standards and be capable of withstanding applied design loads.
6. Loads are based on anchor installed in either the web or grout-filled cell opening in the top of wall.

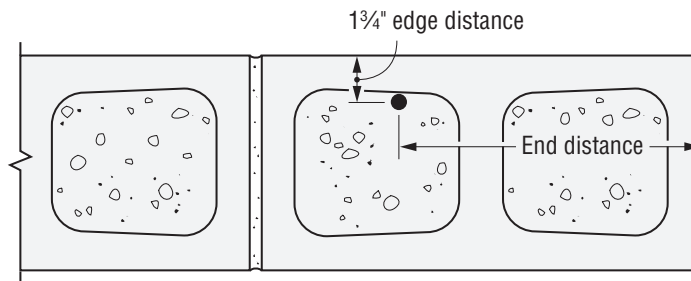

**Figure 6.**  
Anchor Installed in Top of Wall at 1 3/4" Edge Distance

## Titen HD® Allowable Tension and Shear Loads in 8" Medium-Weight and Normal-Weight Grout-Filled CMU Stemwall



Size in. (mm)	Drill Bit Diameter in.	Embed. Depth in. (mm)	Minimum Edge Distance in. (mm)	Minimum End Distance in. (mm)	Critical Spacing Distance in. (mm)	8" Grout-Filled CMU Allowable Loads Based on CMU Strength, $f'_m = 2,000$ psi					
						Tension		Shear Perpendicular to Edge		Shear Parallel to Edge	
						Ultimate lb. (kN)	Allowable lb. (kN)	Ultimate lb. (kN)	Allowable lb. (kN)	Ultimate lb. (kN)	Allowable lb. (kN)
<b>Anchor Installed in Cell Opening (Top of Wall) (See Figure 7)</b>											
1/2 (12.7)	1/2	4 1/2 (114)	3 (76)	12 (305)	12 (305)	5,800 (25.8)	1,160 (5.2)	2,750 (12.2)	550 (2.5)	7,500 (33.4)	1,500 (6.7)
5/8 (15.9)	5/8										

1. The tabulated allowable loads are based on a safety factor of 5.0 for installations under the IBC and IRC.
2. Values are for 8"-wide, medium-weight and normal-weight concrete masonry units.
3. The masonry units must be fully grouted.
4. The minimum specified compressive strength of masonry,  $f'_m$ , at 28 days is 2,000 psi.
5. Allowable loads are not permitted to be increased for short-term loading due to wind or seismic forces.
6. Grout-filled CMU wall design must satisfy applicable design standards and be capable of withstanding applied design loads.
7. Loads are based on anchor installed in grout-filled cell opening in the top of wall.

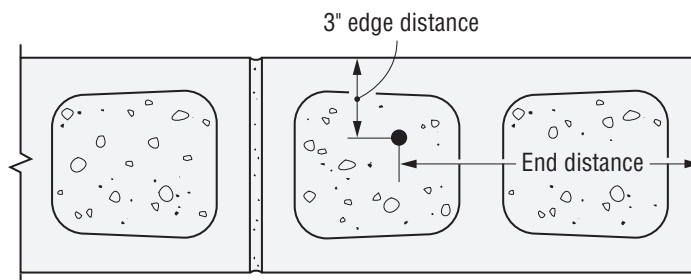

**Figure 7.**  
Anchor Installed in Top of Wall at 3" Edge Distance



# Titen HD® Design Information — Masonry

Titen HD Allowable Tension Loads for 8" Lightweight, Medium-Weight and Normal-Weight CMU Chair Blocks Filled with Normal-Weight Concrete



Size in. (mm)	Drill Bit Diameter (in.)	Minimum Embedment Depth in. (mm)	Minimum Edge Distance in. (mm)	Critical Spacing in. (mm)	8" Concrete-Filled CMU Chair Block Allowable Tension Loads Based on CMU Strength	
					Ultimate lb. (kN)	Allowable lb. (kN)
3/8 (9.5)	3/8	2 3/8 (60)	1 3/4 (44)	9 1/2 (241)	3,175 (14.1)	635 (2.8)
		3 3/8 (86)	1 3/4 (44)	13 1/2 (343)	5,175 (23.0)	1,035 (4.6)
		5 (127)	2 1/4 (57)	20 (508)	10,584 (47.1)	2,115 (9.4)
1/2 (12.7)	1/2	8 (203)	2 1/4 (57)	32 (813)	13,722 (61.0)	2,754 (12.2)
		10 (254)	2 1/4 (57)	40 (1016)	16,630 (74.0)	3,325 (14.8)
5/8 (15.9)	5/8	5 1/2 (140)	1 3/4 (44)	22 (559)	9,025 (40.1)	1,805 (8.1)

1. The tabulated allowable loads are based on a safety factor of 5.0.
2. Values are for 8"-wide concrete masonry units (CMU) filled with concrete, with minimum compressive strength of 2,500 psi and poured monolithically with the floor slab.
3. Center #5 rebar in CMU cell and concrete slab as shown in the illustration below.

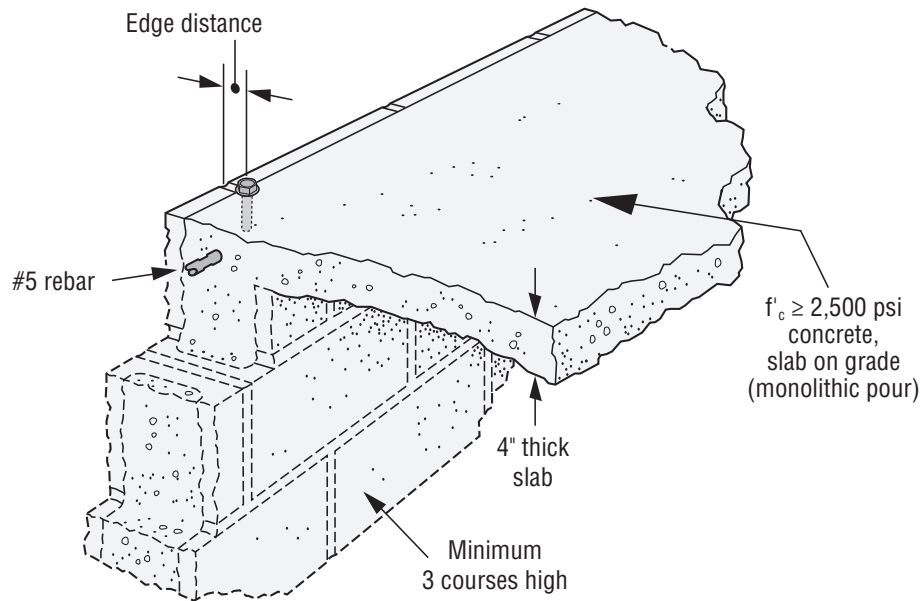

C-A-2021 © 2021 SIMPSON STRONG-TIE COMPANY INC.

\* See p. 12 for an explanation of the load table icons.

# Titen HD® Design Information — Masonry

## Load-Adjustment Factors for Titen HD Anchors in Face-of-Wall Installation in 8" Grout-Filled CMU: Edge Distance and Spacing, Tension and Shear Loads

### How to use these charts:

- The following tables are for reduced edge distance and spacing.
- Locate the anchor size to be used for either a tension and/or shear load application.
- Locate the embedment (E) at which the anchor is to be installed.
- Locate the edge distance ( $c_{act}$ ) or spacing ( $s_{act}$ ) at which the anchor is to be installed.
- The load adjustment factor ( $f_c$  or  $f_s$ ) is the intersection of the row and column.
- Multiply the allowable load by the applicable load adjustment factor.
- Reduction factors for multiple edges or spacings are multiplied together.

### Edge Distance Tension ( $f_c$ )



$c_{act}$ (in.)	Dia.	1/4	3/8	1/2	5/8	3/4
	E	2 1/2	2 3/4	3 1/2	4 1/2	5 1/2
	$c_{cr}$	4	12	12	12	12
	$c_{min}$	1.25	4	4	4	4
	$f_{cmin}$	0.77	1.00	1.00	0.83	0.66
1.25		0.77				
2		0.83				
3		0.92				
4		1.00	1.00	1.00	0.83	0.66
6		1.00	1.00	1.00	0.87	0.75
8		1.00	1.00	1.00	0.92	0.83
10		1.00	1.00	1.00	0.96	0.92
12		1.00	1.00	1.00	1.00	1.00

See footnotes below.

### Edge Distance Shear ( $f_c$ ) Shear Load Parallel to Edge or End



$c_{act}$ (in.)	Dia.	1/4	3/8	1/2	5/8	3/4
	E	2 1/2	2 3/4	3 1/2	4 1/2	5 1/2
	$c_{cr}$	4	12	12	12	12
	$c_{min}$	1.25	4	4	4	4
	$f_{cmin}$	0.58	0.77	0.48	0.46	0.44
1.25		0.58				
2		0.69				
3		0.85				
4		1.00	0.77	0.48	0.46	0.44
6		1.00	0.83	0.61	0.60	0.58
8		1.00	0.89	0.74	0.73	0.72
10		1.00	0.94	0.87	0.87	0.86
12		1.00	1.00	1.00	1.00	1.00

See footnotes below.

### Edge Distance Shear ( $f_c$ ) Shear Load Perpendicular to Edge or End (Directed Towards Edge or End)



$c_{act}$ (in.)	Dia.	1/4	3/8	1/2	5/8	3/4
	E	2 1/2	2 3/4	3 1/2	4 1/2	5 1/2
	$c_{cr}$	4	12	12	12	12
	$c_{min}$	1.25	4	4	4	4
	$f_{cmin}$	0.71	0.58	0.38	0.30	0.21
1.25		0.71				
2		0.79				
3		0.89				
4		1.00	0.58	0.38	0.30	0.21
6		1.00	0.69	0.54	0.48	0.41
8		1.00	0.79	0.69	0.65	0.61
10		1.00	0.90	0.85	0.83	0.80
12		1.00	1.00	1.00	1.00	1.00

- E = embedment depth (inches).
- $c_{act}$  = actual end or edge distance at which anchor is installed (inches).
- $c_{cr}$  = critical end or edge distance for 100% load (inches).
- $c_{min}$  = minimum end or edge distance for reduced load (inches).
- $f_c$  = adjustment factor for allowable load at actual end or edge distance.
- $f_{ccr}$  = adjustment factor for allowable load at critical end or edge distance.  $f_{ccr}$  is always = 1.00.
- $f_{cmin}$  = adjustment factor for allowable load at minimum end or edge distance.
- $f_c = f_{cmin} + [(1 - f_{cmin}) (C_{act} - C_{min}) / (C_{cr} - C_{min})]$ .

\* See p. 12 for an explanation of the load table icons.

# Titen HD® Design Information — Masonry

## Load-Adjustment Factors for Titen HD Anchors in Face-of-Wall Installation in 8" Grout-Filled CMU: Edge Distance and Spacing, Tension and Shear Loads (cont.)

### How to use these charts:

1. The following tables are for reduced edge distance and spacing.
2. Locate the anchor size to be used for either a tension and/or shear load application.
3. Locate the embedment (E) at which the anchor is to be installed.
4. Locate the edge distance ( $C_{act}$ ) or spacing ( $S_{act}$ ) at which the anchor is to be installed.
5. The load adjustment factor ( $f_c$  or  $f_s$ ) is the intersection of the row and column.
6. Multiply the allowable load by the applicable load adjustment factor.
7. Reduction factors for multiple edges or spacings are multiplied together.

### Edge Distance Shear ( $f_c$ ) Shear Load Perpendicular to Edge or End (Directed Away From Edge or End)



$C_{act}$ (in.)	Dia.	1/4	3/8	1/2	5/8	3/4
	E	2 1/2	2 3/4	3 1/2	4 1/2	5 1/2
	$C_{cr}$	4	12	12	12	12
	$C_{min}$	1.25	4	4	4	4
	$f_{cmin}$	0.71	0.89	0.79	0.58	0.38
1.25		0.71				
2		0.79				
3		0.89				
4		1.00	0.89	0.79	0.58	0.38
6		1.00	0.92	0.84	0.69	0.54
8		1.00	0.95	0.90	0.79	0.69
10		1.00	0.97	0.95	0.90	0.85
12		1.00	1.00	1.00	1.00	1.00

### Spacing Tension ( $f_s$ )



$S_{act}$ (in.)	Dia.	1/4	3/8	1/2	5/8	3/4
	E	2 1/2	2 3/4	3 1/2	4 1/2	5 1/2
	$S_{cr}$	4	6	8	10	12
	$S_{min}$	2	3	4	5	6
	$f_{smin}$	0.66	0.87	0.69	0.59	0.50
2		0.66				
3		0.83	0.87			
4		1.00	0.91	0.69		
5			0.96	0.77	0.59	
6			1.00	0.85	0.67	0.50
8				1.00	0.84	0.67
10					1.00	0.83
12						1.00

### Spacing Shear ( $f_s$ )



$S_{act}$ (in.)	Dia.	1/4	3/8	1/2	5/8	3/4
	E	2 1/2	2 3/4	3 1/2	4 1/2	5 1/2
	$S_{cr}$	4	6	8	10	12
	$S_{min}$	2	3	4	5	6
	$f_{smin}$	0.87	0.62	0.62	0.62	0.62
2		0.87				
3		0.93	0.62			
4		1.00	0.75	0.62		
5			0.87	0.72	0.62	
6			1.00	0.81	0.70	0.62
8				1.00	0.85	0.75
10					1.00	0.87
12						1.00

1. E = embedment depth (inches).
2.  $S_{act}$  = actual spacing distance at which anchors are installed (inches).
3.  $S_{cr}$  = critical spacing distance for 100% load (inches).
4.  $S_{min}$  = minimum spacing distance for reduced load (inches).
5.  $f_s$  = adjustment factor for allowable load at actual spacing distance.
6.  $f_{scr}$  = adjustment factor for allowable load at critical spacing distance.  $f_{scr}$  is always = 1.00.
7.  $f_{smin}$  = adjustment factor for allowable load at minimum spacing distance.
8.  $f_s = f_{smin} + [(1 - f_{smin}) (S_{act} - S_{min}) / (S_{cr} - S_{min})]$ .

\* See p. 12 for an explanation of the load table icons.

# Stainless-Steel Titen HD® Heavy-Duty Screw Anchor

Mechanical Anchors

## The Next Era of Stainless-Steel Screw Anchor for Concrete and Masonry

Titen HD screw anchors are a trusted anchor solution because they offer the performance that specifiers need and the ease of installation that contractors demand. Until now, however, they were not for use in permanent exterior or corrosive environments. The Titen HD stainless-steel screw anchor for concrete and masonry sets the new standard for when the job calls for installation in multiple types of environments. It is the ultimate choice to provide fast and efficient installation, combined with long-lasting corrosion resistance for an unsurpassed peace-of-mind.

**Innovative** — The serrated carbon-steel threads on the tip of the stainless-steel Titen HD are vital because they undercut the concrete as the anchor is driven into the hole, making way for the rest of the threads to interlock with the concrete. In order for these threads to be durable enough to cut into the concrete, they are formed from carbon steel that is then hardened and brazed onto the tip of the anchor.

**Corrosion Resistant** — For dry, interior applications, carbon-steel corrosion is not a risk, but in any kind of exterior, coastal or chemical environment the anchor would be susceptible to corrosion. With the introduction of the THDSS, there is finally a state-of-the-art anchor solution that combines the corrosion resistance of Type 300 Series stainless steel with the undercutting ability of sacrificial heat-treated carbon-steel cutting threads.

### Features:

- Ideal for exterior or corrosive environments
- Anchor contains minimal carbon steel resulting in less expansion forces in the concrete due to corrosion
- Installs with an impact wrench or with a hand tool
- Tested per ACI355.2, AC193 and AC106

**Codes:** IAPMO UES ER-493 (concrete);  
ICC-ES ESR-1056 (masonry);  
City of LA Supplement within ER-493 (concrete);  
City of LA Supplement within ESR-1056 (masonry);  
Florida FL15730 (masonry); FL16230 (concrete)

**Material:** Type 316 and Type 304 stainless steel with carbon-steel lead threads

### Installation

- Caution:** Holes in steel fixtures to be mounted should match the diameter specified in the table below if steel is thicker than 12 gauge.
- Caution:** Use a Titen HD screw anchor one time only — installing the anchor multiple times may result in excessive thread wear and reduce load capacity. Do not use impact wrenches to install into hollow CMU.
- Caution:** Oversized holes in base material will reduce or eliminate the mechanical interlock of the threads with the base material and reduce the anchor's load capacity.

1. Drill a hole in the base material using a carbide drill bit (complying with ANSI B212.15) with the same diameter as the nominal diameter of the anchor to be installed. Drill the hole to the specified minimum hole depth overdrill (see table below) to allow the thread tapping dust to settle, and blow it clean using compressed air. (Overhead installations need not be blown clean.) Alternatively, drill the hole deep enough to accommodate embedment depth and the dust from drilling and tapping.
2. Insert the anchor through the fixture and into the hole.
3. Tighten the anchor into the base material until the hex-washer head or the countersunk head contacts the fixture.

### Additional Installation Information

Titen HD® Diameter (in.)	Wrench Size (in.)	Recommended Steel Fixture Hole Size (in.)	Minimum Hole Depth Overdrill (in.)
1/4	3/8	3/8 to 7/16	1/8
3/8	9/16	1/2 to 9/16	1/4
1/2	3/4	5/8 to 11/16	1/2
5/8	15/16	3/4 to 13/16	1/2
3/4	1 1/8	7/8 to 15/16	1/2

Suggested fixture hole sizes are for structural steel thicker than 12 gauge only. Larger holes are not required for wood or thinner cold-formed steel members.

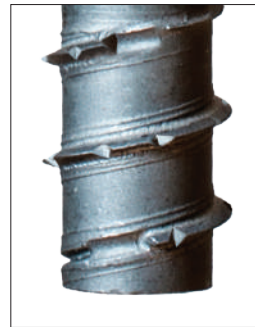

**Innovative Carbon-Steel Lead Threads**

### Installation Sequence

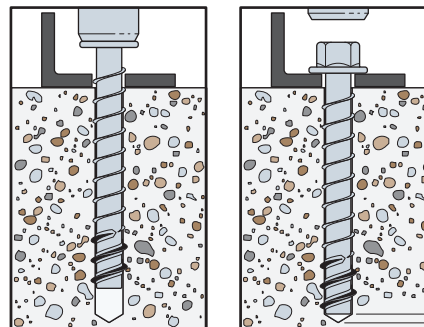
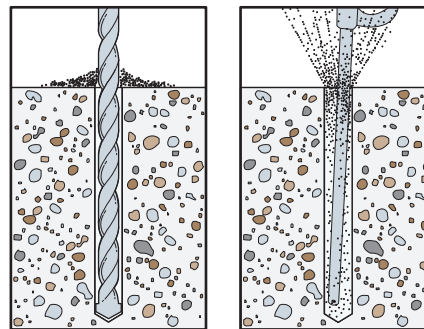

### Stainless-Steel Titen HD Hex-Washer Head Style Screw Anchor

US Patents  
8,747,042 B2  
and 9,517,519

Minimum overdrill. See table.

# Stainless-Steel Titen HD® Heavy-Duty Screw Anchor

## Stainless-Steel Countersunk Head Style

The countersunk head style is for applications that require a flush-mount profile. Countersinking also leaves a cleaner surface appearance for exposed through-set applications. The anchor head's 6-lobe drive eases installation and is less prone to stripping than traditional recessed anchor heads.

### Features

- Available in many standard lengths in 1/4" and 3/8" diameters
- Countersunk head allows screw anchor applications incompatible with a hex head
- Countersunk version includes driver bit in each box

**Codes:** IAPMO UES ER-493 (concrete);  
ICC-ES ESR-1056 (masonry);  
City of LA Supplement within ER-493 (concrete);  
City of LA Supplement within ESR-1056 (masonry);  
Florida FL15730 (masonry); FL16230 (concrete)

**Material:** Type 316 stainless steel with carbon-steel lead threads

### Additional Installation Information

Titen HD Diameter (in.)	Bit Size	Recommended Steel Fixture Hole Size (in.)	Minimum Hole Depth Overdrill (in.)
1/4	T30	3/8 to 7/16	1/8
3/8	T50	1/2 to 9/16	1/4

Suggested fixture hole sizes are for structural steel thicker than 12 gauge only. Larger holes are not required for wood or thinner cold-formed steel members.



**Stainless-Steel Titen HD Countersunk Head Style Screw Anchor**

### Installation Sequence

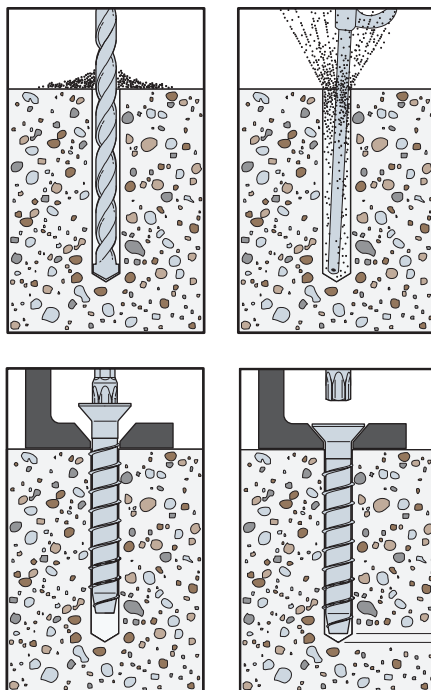

Minimum overdrill. See table.



**Titen HD Countersunk Installation**

## Stainless-Steel Titen HD® Heavy-Duty Screw Anchor

## Stainless-Steel Titen HD Anchor Product Data — Hex Washer Head

Size (in.)	Model No. (Type 316)	Model No. (Type 304)	Thread Length (in.)	Drill Bit Diameter (in.)	Wrench Size (in.)	Quantity	
						Box	Carton
1/4 x 2	THDC25200H6SS†	—	1 7/8	1/4	3/8	50	250
1/4 x 2 3/8	THDC25238H6SS	—	2 1/4	1/4	3/8	50	250
1/4 x 3	THDC25300H6SS	—	2 7/8	1/4	3/8	50	250
1/4 x 4	THDC25400H6SS	—	3 3/8	1/4	3/8	50	250
3/8 x 3	THD37300H6SS	THD37300H4SS	2 1/2	3/8	9/16	50	200
3/8 x 4	THD37400H6SS	THD37400H4SS	3 1/2	3/8	9/16	50	200
3/8 x 5	THD37500H6SS	THD37500H4SS	4 1/2	3/8	9/16	50	100
3/8 x 6	THD37600H6SS	THD37600H4SS	5 1/2	3/8	9/16	50	100
1/2 x 3	THD50300H6SS	THD50300H4SS	2 1/2	1/2	3/4	25	100
1/2 x 4	THD50400H6SS	THD50400H4SS	3 1/2	1/2	3/4	20	80
1/2 x 5	THD50500H6SS	THD50500H4SS	4 1/2	1/2	3/4	20	80
1/2 x 6	THD50600H6SS	THD50600H4SS	5 1/2	1/2	3/4	20	80
1/2 x 6 1/2	THD50612H6SS	THD50612H4SS	6	1/2	3/4	20	40
1/2 x 8	THD50800H6SS	THD50800H4SS	6 7/8	1/2	3/4	20	40
5/8 x 4	THDB62400H6SS	THDB62400H4SS	3 1/2	5/8	15/16	10	40
5/8 x 5	THDB62500H6SS	THDB62500H4SS	4 1/2	5/8	15/16	10	40
5/8 x 6	THDB62600H6SS	THDB62600H4SS	5 1/2	5/8	15/16	10	40
5/8 x 6 1/2	THDB62612H6SS	THDB62612H4SS	6	5/8	15/16	10	40
5/8 x 8	THDB62800H6SS	THDB62800H4SS	7 1/16	5/8	15/16	10	20
3/4 x 4	THD75400H6SS	THD75400H4SS	3 1/2	3/4	1 1/8	10	40
3/4 x 5	THD75500H6SS	THD75500H4SS	4 1/2	3/4	1 1/8	5	20
3/4 x 6	THD75600H6SS	THD75600H4SS	5 1/2	3/4	1 1/8	5	20
3/4 x 7	THD75700H6SS	THD75700H4SS	6 1/2	3/4	1 1/8	5	10
3/4 x 8 1/2	THD75812H6SS	THD75812H4SS	7 3/16	3/4	1 1/8	5	10

† Does not meet minimum embedment in code report.

1. Anchor length is measured from under head to bottom of anchor.

## Stainless-Steel Titen HD Anchor Product Data — Countersunk

Size (in.)	Model No. (Type 316)	Thread Length (in.)	Drill Bit Diameter (in.)	Wrench Size (in.)	Quantity	
					Box	Carton
1/4 x 2 3/8	THDC25238CS6SS†	2	1/4	T30	25	250
1/4 x 3	THDC25300CS6SS	2 5/8	1/4	T30	25	250
1/4 x 4	THDC25400CS6SS	3 5/8	1/4	T30	25	250
3/8 x 2 1/2	THD37212CS6SS†	2	3/8	T50	25	125
3/8 x 3	THD37300CS6SS	2 1/2	3/8	T50	25	125
3/8 x 4	THD37400CS6SS	3 1/2	3/8	T50	25	125

† These models do not meet minimum embedment depth requirements for strength design and require maximum installation torque of 25 ft. – lb. using a torque wrench, driver drill or cordless 1/4" impact driver with a maximum permitted torque rating of 100 ft. – lb.

1. Anchor length is measured from top of head to bottom of anchor.

## Stainless-Steel Titen HD® Design Information — Concrete

Stainless-Steel Titen HD Installation Information<sup>1</sup>

Characteristic	Symbol	Units	Nominal Anchor Diameter (in.)									
			¼	⅜	½	⅝	¾	7/8	1	1 1/8	1 1/4	1 3/8
<b>Installation Information</b>												
Nominal Diameter	$d_a$	in.	¼	⅜	½	⅝	¾	7/8	1	1 1/8	1 1/4	1 3/8
Drill Bit Diameter	$d_{bit}$	in.	¼	⅜	½	⅝	¾	7/8	1	1 1/8	1 1/4	1 3/8
Minimum Baseplate Clearance Hole Diameter <sup>2</sup>	$d_c$	in.	⅜	½	⅝	¾	7/8	1	1 1/8	1 1/4	1 3/8	1 7/8
Maximum Installation Torque <sup>3</sup>	$T_{inst,max}$	ft.-lbf.	N/A	40	70	85	150					
Maximum Impact Wrench Torque Rating	$T_{impact,max}$	ft.-lbf.	125	150	345	345	380					
Minimum Hole Depth	$h_{hole}$	in.	2 1/4	3 1/8	2 3/4	3 1/2	3 3/4	4 1/2	4 1/2	6	6	6 3/4
Nominal Embedment Depth	$h_{nom}$	in.	2 1/8	3	2 1/2	3 1/4	3 1/4	4	4	5 1/2	5 1/2	6 1/4
Effective Embedment Depth	$h_{ef}$	in.	1.27	2.01	1.40	2.04	1.86	2.50	2.31	3.59	3.49	4.13
Critical Edge Distance	$c_{ac}$	in.	3	3	4 1/2	5 1/2	6	5 3/4	6	6 3/8	6 3/4	7 3/8
Minimum Edge Distance	$c_{min}$	in.	1 1/2	1 1/2	1 3/4	1 3/4	1 3/4	2 1/4	1 3/4	1 3/4	1 3/4	1 3/4
Minimum Spacing	$s_{min}$	in.	1 1/2	1 1/2	3	3	4	3	3	3	3	3
Minimum Concrete Thickness	$h_{min}$	in.	3 1/2	4 3/8	4	5	5	6 1/4	6	8 1/2	8 3/4	10
<b>Anchor Data</b>												
Yield Strength	$f_{ya}$	psi	88,000	98,400	91,200	83,200	92,000					
Tensile Strength	$f_{uta}$	psi	110,000	123,000	114,000	104,000	115,000					
Minimum Tensile and Shear Stress Area	$A_{se}$	in. <sup>2</sup>	0.0430	0.099	0.1832	0.276	0.414					
Axial Stiffness in Service Load Range — Uncracked Concrete	$\beta_{uncr}$	lb./in.	139,300	807,700	269,085	111,040	102,035					
Axial Stiffness in Service Load Range — Cracked Concrete	$\beta_{cr}$	lb./in.	103,500	113,540	93,675	94,400	70,910					

For **SI**: 1 in. = 25.4 mm, 1 ft.-lbf. = 1.356 N-m, 1 psi = 6.89 kPa, 1 in.<sup>2</sup> = 645 mm<sup>2</sup>, 1 lb./in. = 0.175 N/mm.

- The information presented in this table is to be used in conjunction with the design criteria of ACI 318-14 Chapter 17 or ACI 318-11 Appendix D, as applicable.
- The minimum hole size must comply with applicable code requirements for the connected element.
- $T_{inst,max}$  applies to installations using a calibrated torque wrench.

## Stainless-Steel Titen HD® Design Information — Concrete

Stainless-Steel Titen HD Tension Strength Design Data<sup>1,5</sup>

Characteristic	Symbol	Units	Nominal Anchor Diameter (in.)									
			1/4	3/8	1/2	5/8	3/4	1	1 1/4	1 1/2	1 3/4	2
Anchor Category	1, 2 or 3	—	3			1						
Nominal Embedment Depth	$h_{nom}$	in.	2 1/8	3	2 1/2	3 1/4	3 1/4	4	4	5 1/2	5 1/2	6 1/4
<b>Steel Strength in Tension (ACI 318-14 17.4.1 or ACI 318-11 Section D.5.1)</b>												
Tension Resistance of Steel	$N_{sa}$	lbf.	4,730	12,177	20,885	28,723	47,606					
Strength Reduction Factor — Steel Failure <sup>2</sup>	$\phi_{sa}$	—	0.75									
<b>Concrete Breakout Strength in Tension (ACI 318-14 17.4.2 or ACI 318 Section D.5.2)</b>												
Effective Embedment Depth	$h_{ef}$	in.	1.27	2.01	1.40	2.04	1.86	2.50	2.31	3.59	3.49	4.13
Critical Edge Distance	$c_{ac}$	in.	3	3	4 1/2	5 1/2	6	5 3/4	6	6 3/8	6 3/4	7 3/8
Effectiveness Factor — Uncracked Concrete	$k_{uncr}$	—	24	24	27	24	27	24	24	24	27	27
Effectiveness Factor — Cracked Concrete	$k_{cr}$	—	17	17	21	17	17	17	17	17	17	21
Modification Factor	$\Psi_{c,N}$	—	1									
Strength Reduction Factor — Concrete Breakout Failure <sup>3</sup>	$\phi_{cb}$	—	0.45				0.65					
<b>Pullout Strength in Tension (ACI 318-14 17.4.3 or ACI 318-11 Section D.5.3)</b>												
Pullout Resistance Uncracked Concrete ( $f'_c = 2,500$ psi)	$N_{p,uncr}$	lbf.	1,725 <sup>5</sup>	3,550 <sup>6</sup>	N/A <sup>4</sup>	N/A <sup>4</sup>	N/A <sup>4</sup>	N/A <sup>4</sup>	3,820 <sup>5</sup>	9,080 <sup>7</sup>	N/A <sup>4</sup>	N/A <sup>4</sup>
Pullout Resistance Cracked Concrete ( $f'_c = 2,500$ psi)	$N_{p,cr}$	lbf.	695 <sup>5</sup>	1,225 <sup>5</sup>	1,675 <sup>5</sup>	2,415 <sup>5</sup>	1,995 <sup>5</sup>	N/A <sup>4</sup>	N/A <sup>4</sup>	N/A <sup>4</sup>	N/A <sup>4</sup>	N/A <sup>4</sup>
Strength Reduction Factor — Pullout Failure <sup>6</sup>	$\phi_p$	—	0.45				0.65					
<b>Tension Strength for Seismic Applications (ACI 318-14 17.2.3.3 or ACI 318-11 Section D.3.3.3)</b>												
Nominal Pullout Strength for Seismic Loads ( $f'_c = 2,500$ psi)	$N_{p,eq}$	lbf.	695 <sup>5</sup>	1,225 <sup>5</sup>	1,675 <sup>5</sup>	2,415 <sup>5</sup>	1,995 <sup>5</sup>	N/A <sup>4</sup>	N/A <sup>4</sup>	N/A <sup>4</sup>	N/A <sup>4</sup>	N/A <sup>4</sup>
Strength Reduction Factor for Pullout Failure <sup>6</sup>	$\phi_{eq}$	—	0.45				0.65					

For SI: 1 in. = 25.4 mm, 1 ft.-lbf. = 1.356 N-m, 1 psi = 6.89 kPa, 1 in.<sup>2</sup> = 645 mm<sup>2</sup>, 1 lb./in. = 0.175 N/mm.

- The information presented in this table is to be used in conjunction with the design criteria of ACI 318-14 Chapter 17 or ACI 318-11 Appendix D, as applicable.
- The tabulated value of  $\phi_{sa}$  applies when the load combinations of Section 1605.2 of the IBC, ACI 318-14 Section 5.3 or ACI 318-11 Section 9.2 are used, as applicable. If the load combinations of ACI 318-11 Appendix C are used, the appropriate value of  $\phi$  must be determined in accordance with ACI 318 D.4.4(b), as applicable.
- The tabulated values of  $\phi_{cb}$  applies when both the load combinations of Section 1605.2 of the IBC, ACI 318-14 Section 5.3 or ACI 318-11 Section 9.2, as applicable, are used and the requirements of ACI 318-14 17.3.3(c) or ACI 318-11 D.4.3(c) for Condition B are met. Condition B applies where supplementary reinforcement is not provided in concrete. For installations where complying reinforcement can be verified, the  $\phi_{cb}$  factors described in ACI 318-14 17.3.3(c) or ACI 318-11 D.4.3(c), as applicable, may be used for Condition A. If the load combinations of ACI 318 Appendix C are used, the appropriate value of  $\phi$  must be determined in accordance with ACI 318 D.4.4(c) for Condition B.
- N/A denotes that pullout resistance does not govern and does not need to be considered.
- The characteristic pullout resistance for greater compressive strengths may be increased by multiplying the tabular value by  $(f'_c/2,500)^{0.5}$ .
- The tabulated values of  $\phi_p$  or  $\phi_{eq}$  applies when both the load combinations of ACI 318-14 Section 5.3 or ACI 318-11 Section 9.2, as applicable, are used and the requirements of ACI 318-14 17.3.3(c) or ACI 318-11 D.4.3(c) for Condition B are met. If the load combinations of ACI 318 Appendix C are used, the appropriate value of  $\phi$  must be determined in accordance with ACI 318 D.4.4(c) for Condition B.
- The characteristic pullout resistance for greater compressive strengths may be increased by multiplying the tabular value by  $(f'_c/2,500)^{0.4}$ .
- The characteristic pullout resistance for greater compressive strengths may be increased by multiplying the tabular value by  $(f'_c/2,500)^{0.3}$ .

\* See p. 12 for an explanation of the load table icons.



## Stainless-Steel Titen HD® Design Information — Concrete

Stainless-Steel Titen HD Shear Strength Design Data<sup>1</sup>

Characteristic	Symbol	Units	Nominal Anchor Diameter (in.)									
			¼		⅜		½		⅝		¾	
Anchor Category	1, 2 or 3	—	3				1					
Nominal Embedment Depth	$h_{nom}$	in.	2½	3	2½	3¼	3¼	4	4	5½	5½	6¼
<b>Steel Strength in Shear (ACI 318-14 17.5.1 or ACI 318-11 Section D.6.1)</b>												
Shear Resistance of Steel	$V_{sa}$	lbf.	2,285	3,790	4,780	6,024	7,633	10,422	10,649	13,710	19,161	
Strength Reduction Factor — Steel Failure <sup>2</sup>	$\phi_{sa}$	—	0.65									
<b>Concrete Breakout Strength in Shear (ACI 318-14 17.5.2 or ACI 318-11 Section D.6.2)</b>												
Nominal Diameter	$d_a$	in.	0.250		0.375		0.500		0.625		0.750	
Load Bearing Length of Anchor in Shear	$l_e$	in.	1.27	2.01	1.40	2.04	1.86	2.50	2.31	3.59	3.49	4.13
Strength Reduction Factor — Concrete Breakout Failure <sup>3</sup>	$\phi_{cb}$	—	0.70									
<b>Concrete Pryout Strength in Shear (ACI 318-14 17.5.3 or ACI 318-11 Section D.6.3)</b>												
Coefficient for Pryout Strength	$k_{cp}$	—	1.0				2.0	1.0	2.0			
Strength Reduction Factor — Concrete Pryout Failure <sup>4</sup>	$\phi_{cp}$	—	0.70									
<b>Shear Strength for Seismic Applications (ACI 318-14 17.2.3.3 or ACI 318-11 Section D.3.3.3)</b>												
Shear Resistance — Single Anchor for Seismic Loads ( $f'_c = 2,500$ psi)	$V_{sa,eq}$	lbf.	1,370	1,600	3,790	4,780	5,345	6,773	9,367	9,367	10,969	10,969
Strength Reduction Factor — Steel Failure <sup>2</sup>	$\phi_{eq}$	—	0.65									

For **SI**: 1 in. = 25.4mm, 1 lbf. = 4.45N.

- The information presented in this table is to be used in conjunction with the design criteria of ACI 318-14 Chapter 17 or ACI 318-11 Appendix D, as applicable.
- The tabulated value of  $\phi_{sa}$  and  $\phi_{eq}$  applies when the load combinations of Section 1605.2 of the IBC, ACI 318-14 Section 5.3 or ACI 318-11 Section 9.2, as applicable, are used. If the load combinations of ACI 318 Appendix C are used, the appropriate value of  $\phi_{sa}$  and  $\phi_{eq}$  must be determined in accordance with ACI 318 D.4.4(b).
- The tabulated value of  $\phi_{cb}$  applies when both the load combinations of Section 1605.2.1 of the IBC, ACI 318-14 Section 5.3 or ACI 318-11 Section 9.2 are used and the requirements of ACI 318-14 17.3.3(c) or ACI 318-11 D.4.3(c) for Condition B are met. Condition B applies where supplementary reinforcement is not provided. For installations where complying supplementary reinforcement can be verified, the  $\phi_{cb}$  factors described in ACI 318-14 17.3.3(c) or ACI 318-11 D.4.3(c) for Condition A are allowed. If the load combinations of ACI 318-11 Appendix C are used, the appropriate value of  $\phi_{cb}$  must be determined in accordance with ACI 318-11 D.4.4(c).
- The tabulated value of  $\phi_{cp}$  applies when both the load combinations of IBC Section 1605.2, ACI 318-14 5.3 or ACI 318-11 Section 9.2 are used and the requirements of ACI 318-14 17.3.3(c) or ACI 318-11 D.4.3(c) for Condition B are met. If the load combinations of ACI 318-11 Appendix C are used, appropriate value of  $\phi_{cp}$  must be determined in accordance with ACI 318-11 Section D.4.4(c).

# Stainless-Steel Titen HD® Design Information — Concrete

Stainless-Steel Titen HD Screw Anchor Setting Information for Installation on the Top of Concrete-Filled Profile Steel Deck Floor and Roof Assemblies<sup>1,2,3,4</sup>

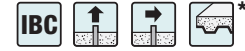

Design Information	Symbol	Units	Nominal Anchor Diameter (in.)		
			¼	⅜	½
Nominal Embedment Depth	$h_{nom}$	in.	2½	2½	3¼
Effective Embedment Depth	$h_{ef}$	in.	1.27	1.40	1.86
Minimum Concrete Thickness <sup>5</sup>	$h_{min,deck}$	in.	2½	3¼	3¾
Critical Edge Distance	$c_{ac,deck,top}$	in.	3	4½	7½
Minimum Edge Distance	$c_{min,deck,top}$	in.	1½	1¾	1¾
Minimum Spacing	$s_{min,deck,top}$	in.	1½	3	3

For SI: 1 in. = 25.4 mm, 1 lbf = 4.45 N.

- For anchors installed in the topside of concrete-filled deck assemblies, as shown in Figure 1, the nominal concrete breakout strength of a single anchor or group of anchors in shear,  $V_{cb}$  or  $V_{cbg}$ , respectively, must be calculated in accordance with ACI 318-14 Section 17.5.2 or ACI 318-11 Section D.6.2, using the actual member thickness,  $h_{min,deck}$ , in the determination of  $A_{vc}$ .
- Design capacity shall be based on calculations according to values in the tables featured on pp. 96–97.
- Minimum flute depth (distance from top of flute to bottom of flute) is 1½" (see Figure 1).
- Steel deck thickness shall be minimum 20 gauge.
- Minimum concrete thickness ( $h_{min,deck}$ ) refers to concrete thickness above upper flute (see Figure 1).

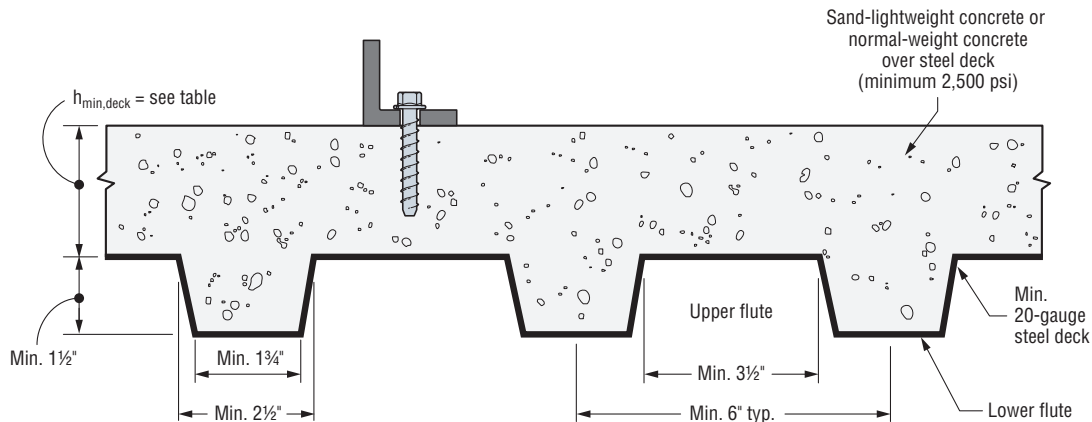
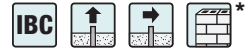

**Figure 1.** Installation of ¼"-, ⅜"- and ½"-Diameter Anchors in the Topside of Concrete over Steel Deck

\* See p. 12 for an explanation of the load table icons.

# Stainless-Steel Titen HD® Design Information — Masonry

Stainless-Steel Titen HD Allowable Tension and Shear Loads in 8" Medium-Weight and Normal-Weight Grout-Filled CMU



Size in. (mm)	Drill Bit Diameter in.	Minimum Embedment Depth in. (mm)	Critical Edge Distance $C_{crit}$ in. (mm)	Minimum Edge Distance $C_{min}$ in. (mm)	Critical Spacing Distance in. (mm)	Values for 8" Medium-Weight or Normal-Weight Grout-Filled CMU			
						Tension Load		Shear Load	
						Ultimate lb. (kN)	Allowable lb. (kN)	Ultimate lb. (kN)	Allowable lb. (kN)
<b>Anchor Installed in the Face of the CMU Wall (See Figure 1)</b>									
¼ (6.4)	¼	2½ (64)	4 (102)	1¼ (32)	4 (102)	1,325 (5.9)	265 (1.2)	1,400 (6.2)	280 (1.3)
⅜ (9.5)	⅜	2¾ (70)	12 (305)	4 (102)	8 (203)	2,125 (9.5)	425 (1.9)	2,850 (12.7)	570 (2.5)
½ (12.7)	½	3½ (89)	12 (305)	4 (102)	8 (203)	3,325 (14.8)	665 (3.0)	4,950 (22.0)	990 (4.4)
⅝ (15.9)	⅝	4½ (114)	12 (305)	4 (102)	8 (203)	3,850 (17.1)	770 (3.4)	4,925 (21.9)	985 (4.4)
¾ (19.1)	¾	5½ (140)	12 (305)	4 (102)	8 (203)	5,200 (23.1)	1,040 (4.6)	4,450 (19.8)	890 (4.0)

1. The tabulated allowable loads are based on a safety factor of 5.0 for installations under the IBC and IRC.
2. Values for 8"-wide, medium-weight and normal-weight concrete masonry units.  
For ⅝"- to ¾"-diameter anchors, anchors may be installed in lightweight masonry units.
3. The masonry units must be fully grouted.
4. The minimum specified compressive strength of masonry,  $f'_m$ , at 28 days is 2,000 psi.
5. Embedment depth is measured from the outside face of the concrete masonry unit.
6. Grout-filled CMU wall design must satisfy applicable design standards and be capable of withstanding applied loads.
7. Refer to allowable load-adjustment factors for spacing and edge distance on pp. 101–102.
8. Although the ¼" stainless steel Titen HD is not part of the evaluation report, we still tested the ¼" screw per the appropriate AC.

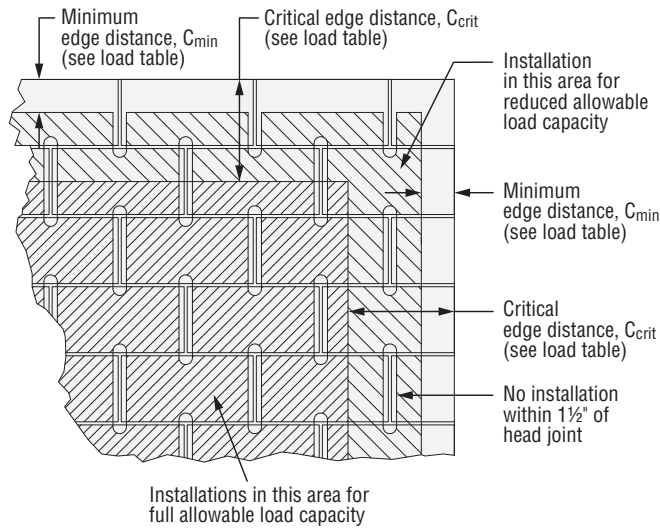

**Figure 1.** Shaded Area = Placement for Full and Reduced Allowable Load Capacity in Grout-Filled CMU

\* See p. 12 for an explanation of the load table icons.

# Stainless-Steel Titen HD® Design Information — Masonry

Stainless-Steel Titen HD Allowable Tension and Shear Loads  
in 8" Lightweight, Medium-Weight and Normal-Weight Hollow CMU



Mechanical Anchors

Size in. (mm)	Drill Bit Diameter in.	Minimum Embedment Depth <sup>4</sup> in. (mm)	Critical Edge Distance in. (mm)	Critical Spacing Distance in. (mm)	8" Hollow CMU Loads Based on CMU Strength			
					Tension Load		Shear Load	
					Ultimate lb. (kN)	Allowable lb. (kN)	Ultimate lb. (kN)	Allowable lb. (kN)
<b>Anchor Installed in Face Shell (See Figure 2)</b>								
3/8 (9.5)	3/8	2 1/2 (64)	12 (305)	8 (203)	925 (4.1)	185 (0.8)	2,250 (10.0)	450 (2.0)
1/2 (12.7)	1/2	2 1/2 (64)	12 (305)	8 (203)	1,025 (4.6)	205 (0.9)	2,325 (10.3)	465 (2.1)
5/8 (15.9)	5/8	2 1/2 (64)	12 (305)	8 (203)	550 (2.4)	110 (0.5)	2,025 (9.0)	405 (1.8)
3/4 (19.1)	3/4	2 1/2 (64)	12 (305)	8 (203)	775 (3.4)	155 (0.7)	1,975 (8.8)	395 (1.8)

- The tabulated allowable loads are based on a safety factor of 5.0 for installations under the IBC and IRC.
- Values for 8"-wide, lightweight, medium-weight and normal-weight concrete masonry units.
- The minimum specified compressive strength of masonry,  $f_m$ , at 28 days is 2,000 psi.
- Embedment depth is measured from the outside face of the concrete masonry unit and is based on the anchor being embedded an additional 1 1/4" through 1 1/4"-thick face shell.
- Allowable loads may not be increased for short-term loading due to wind or seismic forces. CMU wall design must satisfy applicable design standards and be capable of withstanding applied loads.
- Do not use impact wrenches to install in hollow CMU.
- Set drill to rotation-only mode when drilling into hollow CMU.
- Refer to allowable load-adjustment factors for spacing and edge distance on p. 103.
- Anchors must be installed a minimum of 1 1/2" from vertical head joints and T-joints. Refer to Figure 2 for permitted and prohibited anchor installation locations.

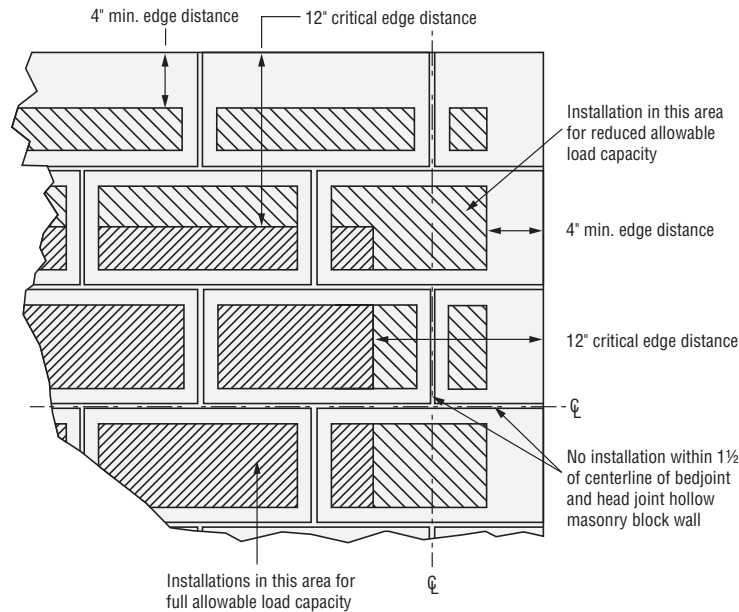

**Figure 2.** Stainless-Steel Titen HD Screw Anchor Installed in the Face of Hollow CMU Wall Construction

\* See p. 12 for an explanation of the load table icons.

# Stainless-Steel Titen HD® Design Information — Masonry

## Load-Adjustment Factors for Stainless-Steel Titen HD Anchors in Face-of-Wall Installation in 8" Grout-Filled CMU: Edge Distance and Spacing, Tension and Shear Loads

### How to use these charts:

1. The following tables are for reduced edge distance and spacing.
2. Locate the anchor size to be used for either a tension and/or shear load application.
3. Locate the embedment (E) at which the anchor is to be installed.
4. Locate the edge distance ( $c_{act}$ ) or spacing ( $s_{act}$ ) at which the anchor is to be installed.
5. The load adjustment factor ( $f_c$  or  $f_s$ ) is the intersection of the row and column.
6. Multiply the allowable load by the applicable load adjustment factor.
7. Reduction factors for multiple edges or spacings are multiplied together.

### Edge Distance Tension ( $f_c$ )



$c_{act}$ (in.)	Dia.	1/4	3/8	1/2	5/8	3/4
	E	2 1/2	2 3/4	3 1/2	4 1/2	5 1/2
	$c_{cr}$	4	12	12	12	12
	$c_{min}$	1.25	4	4	4	4
	$f_{cmin}$	0.84	0.80	0.81	1.00	1.00
1.25		0.84				
2		0.88				
3		0.94				
4		1.00	0.80	0.81	1.00	1.00
6		1.00	0.85	0.86	1.00	1.00
8		1.00	0.90	0.91	1.00	1.00
10		1.00	0.95	0.95	1.00	1.00
12		1.00	1.00	1.00	1.00	1.00

See footnotes below.

### Edge Distance Shear ( $f_c$ )

#### Shear Load Parallel to Edge or End



$c_{act}$ (in.)	Dia.	1/4	3/8	1/2	5/8	3/4
	E	2 1/2	2 3/4	3 1/2	4 1/2	5 1/2
	$c_{cr}$	4	12	12	12	12
	$c_{min}$	1.25	4	4	4	4
	$f_{cmin}$	0.89	0.88	0.56	0.65	0.84
1.25		0.89				
2		0.92				
3		0.96				
4		1.00	0.88	0.56	0.65	0.84
6		1.00	0.91	0.67	0.74	0.88
8		1.00	0.94	0.78	0.83	0.92
10		1.00	0.97	0.89	0.91	0.96
12		1.00	1.00	1.00	1.00	1.00

See footnotes below.

### Edge Distance Shear ( $f_c$ )

#### Shear Load Perpendicular to Edge or End (Directed Towards Edge or End)



$c_{act}$ (in.)	Dia.	1/4	3/8	1/2	5/8	3/4
	E	2 1/2	2 3/4	3 1/2	4 1/2	5 1/2
	$c_{cr}$	4	12	12	12	12
	$c_{min}$	1.25	4	4	4	4
	$f_{cmin}$	0.33	0.93	0.48	0.66	0.69
1.25		0.33				
2		0.51				
3		0.76				
4		1.00	0.93	0.48	0.66	0.69
6		1.00	0.95	0.61	0.75	0.77
8		1.00	0.97	0.74	0.83	0.85
10		1.00	0.98	0.87	0.92	0.92
12		1.00	1.00	1.00	1.00	1.00

1. E = embedment depth (inches).
2.  $c_{act}$  = actual end or edge distance at which anchor is installed (inches).
3.  $c_{cr}$  = critical end or edge distance for 100% load (inches).
4.  $c_{min}$  = minimum end or edge distance for reduced load (inches).
5.  $f_c$  = adjustment factor for allowable load at actual end or edge distance.
6.  $f_{ccr}$  = adjustment factor for allowable load at critical end or edge distance.  $f_{ccr}$  is always = 1.00.
7.  $f_{cmin}$  = adjustment factor for allowable load at minimum end or edge distance.
8.  $f_c = f_{cmin} + [(1 - f_{cmin}) (c_{act} - c_{min}) / (c_{cr} - c_{min})]$ .

\* See p. 12 for an explanation of the load table icons.

# Stainless-Steel Titen HD® Design Information — Masonry

## Load-Adjustment Factors for Stainless-Steel Titen HD Anchors in Face-of-Wall Installation in 8" Grout-Filled CMU: Edge Distance and Spacing, Tension and Shear Loads (cont.)

### How to use these charts:

1. The following tables are for reduced edge distance and spacing.
2. Locate the anchor size to be used for either a tension and/or shear load application.
3. Locate the embedment (E) at which the anchor is to be installed.
4. Locate the edge distance ( $c_{act}$ ) or spacing ( $s_{act}$ ) at which the anchor is to be installed.
5. The load adjustment factor ( $f_c$  or  $f_s$ ) is the intersection of the row and column.
6. Multiply the allowable load by the applicable load adjustment factor.
7. Reduction factors for multiple edges or spacings are multiplied together.

Edge Distance Shear ( $f_c$ )  
Shear Load Perpendicular to Edge or End  
(Directed Away From Edge or End)



$c_{act}$ (in.)	Di.	1/4	3/8	1/2	5/8	3/4
	E	2 1/2	2 3/4	3 1/2	4 1/2	5 1/2
	$c_{cr}$	4	12	12	12	12
	$c_{min}$	1.25	4	4	4	4
	$f_{cmin}$	0.33	0.93	0.48	0.66	0.69
1.25		0.33				
2		0.51				
3		0.76				
4		1.00	0.93	0.48	0.66	0.69
6		1.00	0.95	0.61	0.75	0.77
8		1.00	0.97	0.74	0.83	0.85
10		1.00	0.98	0.87	0.92	0.92
12		1.00	1.00	1.00	1.00	1.00

Spacing Tension ( $f_s$ )



$s_{act}$ (in.)	Di.	1/4	3/8	1/2	5/8	3/4
	E	2 1/2	2 3/4	3 1/2	4 1/2	5 1/2
	$s_{cr}$	4	8	8	8	8
	$s_{min}$	2	4	4	4	4
	$f_{smin}$	0.79	0.81	0.79	0.87	0.78
2		0.79				
3		0.90				
4		1.00	0.81	0.79	0.87	0.78
6			0.91	0.90	0.94	0.89
8			1.00	1.00	1.00	1.00

Spacing Shear ( $f_s$ )



$s_{act}$ (in.)	Di.	1/4	3/8	1/2	5/8	3/4
	E	2 1/2	2 3/4	3 1/2	4 1/2	5 1/2
	$s_{cr}$	4	6	8	10	12
	$s_{min}$	2	3	4	5	6
	$f_{smin}$	0.78	1.00	0.86	0.90	0.94
2		0.78				
3		0.89				
4		1.00	1.00	0.86	0.90	0.94
6			1.00	0.93	0.95	0.97
8			1.00	1.00	1.00	1.00

1. E = embedment depth (inches).
2.  $s_{act}$  = actual spacing distance at which anchors are installed (inches).
3.  $s_{cr}$  = critical spacing distance for 100% load (inches).
4.  $s_{min}$  = minimum spacing distance for reduced load (inches).
5.  $f_s$  = adjustment factor for allowable load at actual spacing distance.
6.  $f_{s_{cr}}$  = adjustment factor for allowable load at critical spacing distance.  $f_{s_{cr}}$  is always = 1.00.
7.  $f_{s_{min}}$  = adjustment factor for allowable load at minimum spacing distance.
8.  $f_s = f_{s_{min}} + [(1 - f_{s_{min}}) (s_{act} - s_{min}) / (s_{cr} - s_{min})]$ .

\* See p. 12 for an explanation of the load table icons.

# Stainless-Steel Titen HD® Design Information — Masonry

## Load-Adjustment Factors for Stainless-Steel Titen HD Anchors in Face-of-Wall Installation in 8" Hollow CMU: Edge Distance and Spacing, Tension and Shear Loads

### How to use these charts:

1. The following tables are for reduced edge distance and spacing.
2. Locate the anchor size to be used for either a tension and/or shear load application.
3. Locate the embedment (E) at which the anchor is to be installed.
4. Locate the edge distance ( $c_{act}$ ) or spacing ( $s_{act}$ ) at which the anchor is to be installed.
5. The load adjustment factor ( $f_c$  or  $f_s$ ) is the intersection of the row and column.
6. Multiply the allowable load by the applicable load adjustment factor.
7. Reduction factors for multiple edges or spacings are multiplied together.

### Edge Distance Tension ( $f_c$ )

$c_{act}$ (in.)	Dia.	3/8	1/2	5/8	3/4
	E	2 1/2	2 1/2	2 1/2	2 1/2
	$c_{cr}$	12	12	12	12
	$c_{min}$	4	4	4	4
	$f_{cmin}$	1.00	1.00	1.00	1.00
4		1.00	1.00	1.00	1.00
6		1.00	1.00	1.00	1.00
8		1.00	1.00	1.00	1.00
10		1.00	1.00	1.00	1.00
12		1.00	1.00	1.00	1.00

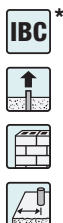

1. E = embedment depth (inches).
2.  $c_{act}$  = actual end or edge distance at which anchor is installed (inches).
3.  $c_{cr}$  = critical end or edge distance for 100% load (inches).
4.  $c_{min}$  = minimum end or edge distance for reduced load (inches).
5.  $f_c$  = adjustment factor for allowable load at actual end or edge distance.
6.  $f_{ccr}$  = adjustment factor for allowable load at critical end or edge distance.  $f_{ccr}$  is always = 1.00.
7.  $f_{cmin}$  = adjustment factor for allowable load at minimum end or edge distance.
8.  $f_c = f_{cmin} + [(1 - f_{cmin})(c_{act} - c_{min}) / (c_{cr} - c_{min})]$ .

### Edge Distance Shear ( $f_c$ )

$c_{act}$ (in.)	Dia.	3/8	1/2	5/8	3/4
	E	2 1/2	2 1/2	2 1/2	2 1/2
	$c_{cr}$	12	12	12	12
	$c_{min}$	4	4	4	4
	$f_{cmin}$	0.78	0.63	0.55	0.51
4		0.78	0.63	0.55	0.51
6		0.84	0.72	0.66	0.63
8		0.89	0.82	0.78	0.76
10		0.95	0.91	0.89	0.88
12		1.00	1.00	1.00	1.00



### Spacing Tension ( $f_s$ ) One Anchor per Cell

$c_{act}$ (in.)	Dia.	3/8	1/2	5/8	3/4
	E	2 1/2	2 1/2	2 1/2	2 1/2
	$c_{cr}$	8	8	8	8
	$c_{min}$	4	4	4	4
	$f_{cmin}$	0.72	0.87	0.89	0.70
4		0.72	0.87	0.89	0.70
6		0.86	0.94	0.95	0.85
8		1.00	1.00	1.00	1.00



See notes below.

### Spacing Tension ( $f_s$ ) Two Anchors per Cell

$c_{act}$ (in.)	Dia.	3/8	1/2	5/8	3/4
	E	2 1/2	2 1/2	2 1/2	2 1/2
	$c_{cr}$	8	8	8	8
	$c_{min}$	4	4	4	4
	$f_{cmin}$	1.00	1.00	1.00	0.78
4		1.00	1.00	1.00	0.78
6		1.00	1.00	1.00	0.89
8		1.00	1.00	1.00	1.00

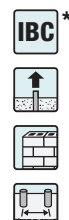

See notes below.

### Spacing Shear ( $f_s$ ) One Anchor per Cell

$s_{act}$ (in.)	Dia.	3/8	1/2	5/8	3/4
	E	2 1/2	2 1/2	2 1/2	2 1/2
	$s_{cr}$	8	8	8	8
	$s_{min}$	4	4	4	4
	$f_{smin}$	0.81	1.00	0.71	0.74
4		0.81	1.00	0.71	0.74
6		0.91	1.00	0.86	0.87
8		1.00	1.00	1.00	1.00



1. E = embedment depth (inches).
2.  $s_{act}$  = actual spacing distance at which anchors are installed (inches).
3.  $s_{cr}$  = critical spacing distance for 100% load (inches).
4.  $s_{min}$  = minimum spacing distance for reduced load (inches).
5.  $f_s$  = adjustment factor for allowable load at actual spacing distance.
6.  $f_{scr}$  = adjustment factor for allowable load at critical spacing distance.  $f_{scr}$  is always = 1.00.
7.  $f_{smin}$  = adjustment factor for allowable load at minimum spacing distance.
8.  $f_s = f_{smin} + [(1 - f_{smin})(s_{act} - s_{min}) / (s_{cr} - s_{min})]$ .

### Spacing Shear ( $f_s$ ) Two Anchors per Cell

$s_{act}$ (in.)	Dia.	3/8	1/2	5/8	3/4
	E	2 1/2	2 1/2	2 1/2	2 1/2
	$s_{cr}$	8	8	8	8
	$s_{min}$	4	4	4	4
	$f_{smin}$	0.76	1.00	0.75	0.75
4		0.76	1.00	0.75	0.75
6		0.88	1.00	0.88	0.88
8		1.00	1.00	1.00	1.00

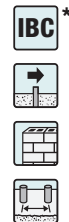

\* See p. 12 for an explanation of the load table icons.

# Titen HD® Rod Coupler

The Titen HD rod coupler is designed to be used in conjunction with a single or multi-story rod tie-down system. This anchor provides a fast and simple way to attach threaded rod to a concrete stem wall or thickened slab footing. Unlike adhesive anchors, the installation requires no special tools, cure time or secondary setting process; just drill a hole and drive the anchor.

## Features

- Now included in ESR-2713 for wind and seismic loading
- The serrated cutting teeth and patented thread design enable the Titen HD rod coupler to be installed quickly and easily. Less installation time translates to lower installed cost.
- The specialized heat treating process creates tip hardness to facilitate cutting while the body remains ductile.
- No special setting tools are required. The Titen HD rod coupler installs with regular or hammer drill, ANSI size bits and standard sockets.
- Compatible with threaded rods in 3/8" and 1/2" diameters.

**Codes:** ICC-ES ESR-2713 (concrete);  
City of LA Supplement within ESR-2713 (concrete);  
FL15730 (concrete)

**Material:** Carbon steel

**Coating:** Zinc plated

## Installation

**⚠ Caution:** Oversized holes in the base material will reduce or eliminate the mechanical interlock of the threads with base material and will reduce the anchor's load capacity. Use a Titen HD Rod Coupler one time only. Installing the anchor multiple times may result in excessive thread wear and reduce load capacity.

1. Drill a hole using the specified diameter carbide bit into the base material to a depth of at least 1/2" deeper than the required embedment.
2. Blow the hole clean of dust and debris using compressed air. Overhead application need not be blown clean.
3. Tighten the anchor with appropriate size socket until the head sits flush against base material.



**Titen HD Rod Coupler**  
US Patent 6,623,228

## Titen HD Rod Coupler Product Data

Size (in.)	Model No.	Accepts Rod Diameter (in.)	Drill Bit Diameter (in.)	Wrench Size (in.)	Quantity	
					Box	Carton
3/8 x 6 3/4	THD37634RC	3/8	3/8	9/16	25	50
1/2 x 9 3/4	THD50934RC	1/2	1/2	3/4	20	40

## Installation Sequence

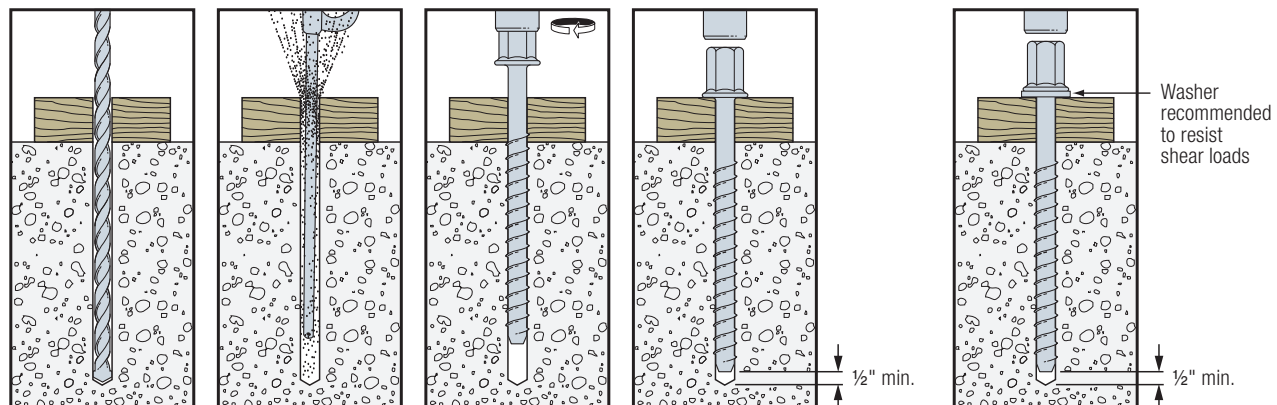



# Titen HD® Rod Coupler



## Titen HD Rod Coupler Installation Information and Additional Data<sup>1</sup>

Characteristic	Symbol	Units	Model No.	
			THD37634RC	THD50934RC
<b>Installation Information</b>				
Nominal Diameter	$d_a$	in.	3/8	1/2
Drill Bit Diameter	$d_{bit}$	in.	3/8	1/2
Internal Thread Diameter	$d_{th}$	—	3/8	1/2
Maximum Installation Torque <sup>2</sup>	$T_{inst,max}$	ft.-lbf.	50	65
Maximum Impact Wrench Torque Rating	$T_{impact,max}$	ft.-lbf.	150	340
Minimum Hole Depth	$h_{hole}$	in.	3 1/2	4 1/2
Nominal Embedment Depth	$h_{nom}$	in.	3 1/4	4
Effective Embedment Depth	$h_{ef}$	in.	2.40	2.99
Critical Edge Distance	$c_{ac}$	in.	3 3/8	4 1/2
Minimum Edge Distance	$c_{min}$	in.	1 3/4	
Minimum Spacing	$s_{min}$	in.	3	
Minimum Concrete Thickness	$h_{min}$	in.	5	6 1/4
<b>Anchor Data</b>				
Yield Strength	$f_{ya}$	psi	97,000	
Tensile Strength	$f_{uta}$	psi	110,000	
Minimum Tensile Stress Area	$A_{se}$	in. <sup>2</sup>	0.099	0.183
Axial Stiffness in Service Load Range — Uncracked Concrete	$\beta_{uncr}$	lb./in.	672,000	
Axial Stiffness in Service Load Range — Cracked Concrete	$\beta_{cr}$	lb./in.	345,000	

- The information presented in this table is to be used in conjunction with the design criteria of ACI 318-14 Chapter 17 or ACI 318-11 Appendix D, as applicable.
- $T_{inst,max}$  applies to installations using a calibrated torque wrench.

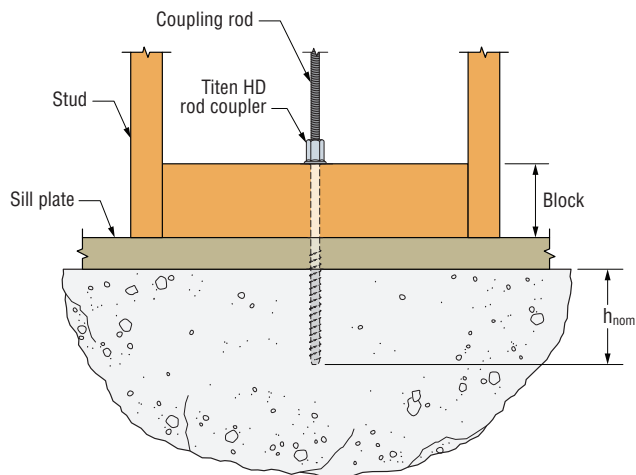

**Figure 1.**  
**Typical Titen HD Rod Coupler Installation Through Blocking and Sill Plate**

### Titen HD Rod Coupler Block Height Requirement

Model No.	Shank Length (in.)	Nominal Embedment Depth (in.)	Sill Plate Thickness	Block Height (in.)
THD37634RC	6 3/4	3 1/4	2x	2
			3x	1
THD50934RC	9 3/4	4	2x	4 1/4
			3x	3 1/4

\* See p. 12 for an explanation of the load table icons.

## Titen HD® Rod Coupler

Titen HD Rod Coupler Tension Strength Design Data<sup>1</sup>

Characteristic	Symbol	Units	Model No.	
			THD37634RC	THD50934RC
Anchor Category	1, 2 or 3	—	1	
Nominal Embedment Depth	$h_{nom}$	in.	3¼	4
<b>Steel Strength in Tension (ACI 318-14 17.4.1 or ACI 318-11 Section D.5.1)</b>				
Tension Resistance of Steel	$N_{sa}$	lbf.	10,890	20,130
Strength Reduction Factor — Steel Failure <sup>2</sup>	$\phi_{sa}$	—	0.65	
<b>Concrete Breakout Strength in Tension (ACI 318-14 17.4.2 or ACI 318 Section D.5.2)</b>				
Effective Embedment Depth	$h_{ef}$	in.	2.4	2.99
Critical Edge Distance	$c_{ac}$	in.	3¾	4½
Effectiveness Factor — Uncracked Concrete	$k_{uncr}$	—	24	
Effectiveness Factor — Cracked Concrete	$k_{cr}$	—	17	
Modification factor	$\Psi_{c,N}$	—	1	
Strength Reduction Factor — Concrete Breakout Failure <sup>3</sup>	$\phi_{cb}$	—	0.65	
<b>Pullout Strength in Tension (ACI 318-14 17.4.3 or ACI 318-11 Section D.5.3)</b>				
Pullout Resistance Uncracked Concrete ( $f'_c = 2,500$ psi)	$N_{p,uncr}$	lbf.	N/A <sup>4</sup>	N/A <sup>4</sup>
Pullout Resistance Cracked Concrete ( $f'_c = 2,500$ psi)	$N_{p,cr}$	lbf.	2,700 <sup>5</sup>	N/A <sup>4</sup>
Strength Reduction Factor — Pullout Failure <sup>6</sup>	$\phi_p$	—	0.65	
<b>Tension Strength for Seismic Applications (ACI 318-14 17.2.3.3 or ACI 318-11 Section D.3.3.3)</b>				
Nominal Pullout Strength for Seismic Loads ( $f'_c = 2,500$ psi)	$N_{p,eq}$	lbf.	2,700 <sup>5</sup>	N/A <sup>4</sup>
Strength Reduction Factor for Pullout Failure <sup>6</sup>	$\phi_{eq}$	—	0.65	

- The information presented in this table is to be used in conjunction with the design criteria of ACI 318-14 Chapter 17 or ACI 318-11 Appendix D, as applicable.
- The tabulated value of  $\phi_{sa}$  applies when the load combinations of Section 1605.2 of the IBC, ACI 318-14 Section 5.3 or ACI 318-11 Section 9.2 are used, as applicable. If the load combinations of ACI 318-11 Appendix C are used, the appropriate value of  $\phi$  must be determined in accordance with ACI 318-11 D.4.4(b), as applicable.
- The tabulated values of  $\phi_{cb}$  applies when both the load combinations of Section 1605.2 of the IBC, ACI 318-14 Section 5.3 or ACI 318-11 Section 9.2, as applicable, are used and the requirements of ACI 318-11 D.4.3(c) for Condition B are met. Condition B applies where supplementary reinforcement is not provided in concrete. For installations where complying reinforcement can be verified, the  $\phi_{cb}$  factors described in ACI 318-14 17.3.3(c) or ACI 318-11 D.4.3(c), as applicable, may be used for Condition A. If the load combinations of ACI 318-11 Appendix C are used, the appropriate value of  $\phi$  must be determined in accordance with ACI 318-11 D.4.4(c) for Condition B.
- As described in this report, N/A denotes that pullout resistance does not govern and does not need to be considered.
- The characteristic pullout resistance for greater compressive strengths may be increased by multiplying the tabular value by  $(f'_c/2,500)^{0.5}$ .
- The tabulated values of  $\phi_p$  or  $\phi_{eq}$  applies when both the load combinations of ACI 318-14 Section 5.3 or ACI 318-11 Section 9w.2, as applicable, are used and the requirements of ACI 318-14 17.3.3(c) or ACI 318-11 D.4.3(c) for Condition B are met. Condition B applies where supplementary reinforcement is not provided in concrete. For installations where complying reinforcement can be verified, the  $\phi_p$  or  $\phi_{eq}$  factors described in ACI 318-14 17.3.3(c) or ACI 318-11 D.4.3(c), as applicable, may be used for Condition A. If the load combinations of ACI 318-11 Appendix C are used, the appropriate value of  $\phi$  must be determined in accordance with ACI 318-11 D.4.4(c) for Condition B.

\* See p. 12 for an explanation of the load table icons.



# Strong-Bolt® 2 Wedge Anchor

Code listed for cracked and uncracked concrete, and masonry applications, the Strong-Bolt 2 wedge-type expansion anchor is an optimal choice for high-performance even in seismic and high-wind conditions. Dual undercutting embossments on each clip segment enable secondary expansion should a crack form and intersect the anchor location; this feature significantly increases the ability of Strong-Bolt 2 to carry load if the hole expands.

## Features

- Chamfered top designed to prevent mushrooming during installation
- Qualified for static and seismic loading conditions (seismic design categories A through F)
- Suitable for horizontal, vertical and overhead applications
- Qualified for minimum concrete thickness of 3¼", and lightweight concrete-over-steel deck thickness of 2½" and 3¼"
- Standard (ANSI) fractional sizes: fits standard fixtures and installs with common drill bit and tool sizes
- Tested per ACI355.2 and AC193

**Material:** Zinc-plated carbon steel or stainless steel (Type 304; Type 316)

**Codes:** ICC-ES ESR-3037 (concrete); IAPMO UES ER-240 (carbon steel in CMU); City of LA Supplement within ESR-3037 (concrete); City of LA Supplement within ER-240 (carbon steel in CMU); Florida FL15730 (concrete); FL16230 (masonry); UL File Ex3605; FM 3043342 and 3047639; Multiple DOT listings; meets the requirements of Federal Specifications A-A-1923A, Type 4

## Installation

 Do not use an impact wrench to set or tighten the Strong-Bolt 2 anchor.

 **Caution:** Oversized holes in the base material will make it difficult to set the anchor and will reduce the anchor's load capacity.

1. Drill a hole in the base material using a carbide drill bit the same diameter as the nominal diameter of the anchor to be installed. Drill the hole to the specified minimum hole depth, and blow it clean using compressed air. (Overhead installations need not be blown clean.) Alternatively, drill the hole deep enough to accommodate embedment depth and dust from drilling.
2. Assemble the anchor with nut and washer so the top of the nut is flush with the top of the anchor. Place the anchor in the fixture, and drive it into the hole until the washer and nut are tight against the fixture.
3. Tighten to the required installation torque.

## Installation Sequence

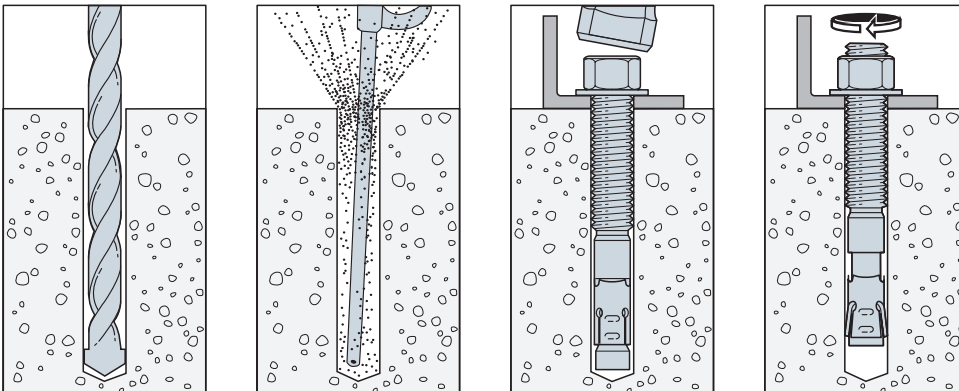

**Strong-Bolt 2  
Wedge Anchor**



### Head Stamp

The head is stamped with the length identification letter, bracketed top and bottom by horizontal lines.

# Strong-Bolt® 2 Wedge Anchor

## Material Specifications

Anchor Body	Nut	Washer	Clip
Carbon Steel (Zinc Plated)	Carbon Steel, ASTM A 563, Grade A	Carbon Steel ASTM F844	Carbon Steel, ASTM A 568
Type 304 Stainless Steel	Type 304 Stainless Steel	Type 304 Stainless Steel	Type 304 or 316 Stainless Steel
Type 316 Stainless Steel	Type 316 Stainless Steel	Type 316 Stainless Steel	Type 316 Stainless Steel

## Strong-Bolt 2 Anchor Installation Data

Strong-Bolt 2 Diameter (in.)	¼	⅜	½	⅝	¾	1
Drill Bit Size (in.)	¼	⅜	½	⅝	¾	1
Min. Fixture Hole (in.)	⅝	⅞	⅞	1⅛	⅞	1⅛
Wrench Size (in.)	⅞	⅞	¾	1⅝	1⅞	1½
Concrete Installation Torque (ft.-lbf.) Carbon Steel	4	30	60	90	150	230
Concrete Installation Torque (ft.-lbf.) Stainless Steel	4	30	65	80	150	—

## Length Identification Head Marks on Strong-Bolt® 2 Wedge Anchors (corresponds to length of anchor – inches)

Mark	Units	A	B	C	D	E	F	G	H	I	J	K	L	M	N	O	P	Q	R	S	T	U	V	W	X	Y	Z
From	in.	1½	2	2½	3	3½	4	4½	5	5½	6	6½	7	7½	8	8½	9	9½	10	11	12	13	14	15	16	17	18
Up To But Not Including	in.	2	2½	3	3½	4	4½	5	5½	6	6½	7	7½	8	8½	9	9½	10	11	12	13	14	15	16	17	18	19

## Strong-Bolt® 2 Wedge Anchor

## Strong-Bolt 2 Anchor Product Data

Size (in.)	Zinc-Plated Carbon Steel Model No.	Type 304 Stainless Steel Model No.	Type 316 Stainless Steel Model No.	Drill Bit Diameter (in.)	Thread Length (in.)	Quantity	
						Box	Carton
¼ x 1¾	STB2-25134	STB2-251344SS	STB2-251346SS	¼	1⅝	100	500
¼ x 2¼	STB2-25214	STB2-252144SS	STB2-252146SS	¼	1⅞	100	500
¼ x 3¼	STB2-25314	STB2-253144SS	STB2-253146SS	¼	2⅞	100	500
⅜ x 2¾	STB2-37234	STB2-372344SS	STB2-372346SS	⅜	1⅝	50	250
⅜ x 3	STB2-37300	STB2-373004SS	STB2-373006SS	⅜	1⅞	50	250
⅜ x 3½	STB2-37312	STB2-373124SS	STB2-373126SS	⅜	2⅞	50	250
⅜ x 3¾	STB2-37334	STB2-373344SS	STB2-373346SS	⅜	2⅝	50	250
⅜ x 5	STB2-37500	STB2-375004SS	STB2-375006SS	⅜	3⅞	50	200
⅜ x 7	STB2-37700	STB2-377004SS	STB2-377006SS	⅜	5⅞	50	200
½ x 3¾	STB2-50334	STB2-503344SS	STB2-503346SS	½	2⅞	25	125
½ x 4¼	STB2-50414	STB2-504144SS	STB2-504146SS	½	2⅞	25	100
½ x 4¾	STB2-50434	STB2-504344SS	STB2-504346SS	½	3⅞	25	100
½ x 5½	STB2-50512	STB2-505124SS	STB2-505126SS	½	3⅞	25	100
½ x 7	STB2-50700	STB2-507004SS	STB2-507006SS	½	5⅞	25	100
½ x 8½	STB2-50812	STB2-508124SS	STB2-508126SS	½	6	25	50
½ x 10	STB2-50100	STB2-501004SS	STB2-501006SS	½	6	25	50
⅝ x 4½	STB2-62412	STB2-624124SS	STB2-624126SS	⅝	2⅞	20	80
⅝ x 5	STB2-62500	STB2-625004SS	STB2-625006SS	⅝	2⅝	20	80
⅝ x 6	STB2-62600	STB2-626004SS	STB2-626006SS	⅝	3⅝	20	80
⅝ x 7	STB2-62700	STB2-627004SS	STB2-627006SS	⅝	4⅝	20	80
⅝ x 8½	STB2-62812	STB2-628124SS	STB2-628126SS	⅝	6	20	40
⅝ x 10	STB2-62100	STB2-621004SS	STB2-621006SS	⅝	6	10	20
¾ x 5½	STB2-75512	STB2-755124SS	STB2-755126SS	¾	3⅞	10	40
¾ x 6¼	STB2-75614	STB2-756144SS	STB2-756146SS	¾	3⅝	10	40
¾ x 7	STB2-75700	STB2-757004SS	STB2-757006SS	¾	4⅞	10	40
¾ x 8½	STB2-75812	STB2-758124SS	STB2-758126SS	¾	6	10	20
¾ x 10	STB2-75100	—	—	¾	6	10	20
1 x 7	STB2-100700	—	—	1	3½	5	20
1 x 10	STB2-1001000	—	—	1	3½	5	10
1 x 13	STB2-1001300	—	—	1	3½	5	10

# Strong-Bolt® 2 Design Information — Concrete

## Carbon-Steel Strong-Bolt 2 Installation Information and Additional Data<sup>1</sup>



Characteristic	Symbol	Units	Nominal Anchor Diameter, $d_a$ (in.)												
			$\frac{1}{4}$ <sup>4</sup>	$\frac{3}{8}$ <sup>5</sup>		$\frac{1}{2}$ <sup>5</sup>		$\frac{5}{8}$ <sup>5</sup>		$\frac{3}{4}$ <sup>5</sup>		$1$ <sup>5</sup>			
<b>Installation Information</b>															
Nominal Diameter	$d_a$	in.	$\frac{1}{4}$	$\frac{3}{8}$		$\frac{1}{2}$		$\frac{5}{8}$		$\frac{3}{4}$		1			
Drill Bit Diameter	$d$	in.	$\frac{1}{4}$	$\frac{3}{8}$		$\frac{1}{2}$		$\frac{5}{8}$		$\frac{3}{4}$		1			
Baseplate Clearance Hole Diameter <sup>2</sup>	$d_c$	in.	$\frac{5}{16}$	$\frac{7}{16}$		$\frac{9}{16}$		$\frac{11}{16}$		$\frac{7}{8}$		$1\frac{1}{8}$			
Installation Torque	$T_{inst}$	ft-lbf	4	30		60		90		150		230			
Nominal Embedment Depth	$h_{nom}$	in.	$1\frac{3}{4}$	$1\frac{7}{8}$	$2\frac{7}{8}$	$2\frac{3}{4}$	$3\frac{7}{8}$	$3\frac{3}{8}$	$5\frac{1}{8}$	$4\frac{1}{8}$	$5\frac{3}{4}$	$5\frac{1}{4}$	$9\frac{3}{4}$		
Effective Embedment Depth	$h_{ef}$	in.	$1\frac{1}{2}$	$1\frac{1}{2}$	$2\frac{1}{2}$	$2\frac{1}{4}$	$3\frac{3}{8}$	$2\frac{3}{4}$	$4\frac{1}{2}$	$3\frac{3}{8}$	5	$4\frac{1}{2}$	9		
Minimum Hole Depth	$h_{hole}$	in.	$1\frac{7}{8}$	2	3	3	$4\frac{1}{8}$	$3\frac{5}{8}$	$5\frac{3}{8}$	$4\frac{3}{8}$	6	$5\frac{1}{2}$	10		
Minimum Overall Anchor Length	$\ell_{anch}$	in.	$2\frac{1}{4}$	$2\frac{3}{4}$	$3\frac{1}{2}$	$3\frac{3}{4}$	$5\frac{1}{2}$	$4\frac{1}{2}$	6	$5\frac{1}{2}$	7	7	13		
Critical Edge Distance	$c_{ac}$	in.	$2\frac{1}{2}$	$6\frac{1}{2}$	6	6	6	$7\frac{1}{2}$	$7\frac{1}{2}$	9	9	8	18	$13\frac{1}{2}$	
Minimum Edge Distance	$c_{min}$	in.	$1\frac{3}{4}$	6		6	4	4	$6\frac{1}{2}$	$6\frac{1}{2}$	$6\frac{1}{2}$	$6\frac{1}{2}$	8		
	for $s \geq$	in.	—	—		6	4	4	—	5	5	8	—		
Minimum Spacing	$s_{min}$	in.	$2\frac{1}{4}$	3		$2\frac{3}{4}$	$2\frac{3}{4}$	$2\frac{3}{4}$	5	$2\frac{3}{4}$	$2\frac{3}{4}$	7	8		
	for $c \geq$	in.	—	—		12	12	12	—	8	8	8	—		
Minimum Concrete Thickness	$h_{min}$	in.	$3\frac{1}{4}$	$3\frac{1}{4}$	$4\frac{1}{2}$	4	$5\frac{1}{2}$	6	$5\frac{1}{2}$	6	$7\frac{7}{8}$	$6\frac{3}{4}$	$8\frac{3}{4}$	9	$13\frac{1}{2}$
<b>Additional Data</b>															
Yield Strength	$f_{ya}$	psi	56,000	92,000		85,000				70,000		60,000			
Tensile Strength	$f_{uta}$	psi	70,000	115,000				110,000		78,000					
Minimum Tensile and Shear Stress Area	$A_{se}$	in. <sup>2</sup>	0.0318	0.0514		0.105		0.166		0.270		0.472			
Axial Stiffness in Service Load Range — Cracked and Uncracked Concrete	$\beta$	lb./in.	73,700 <sup>3</sup>	34,820		63,570		91,370		118,840		299,600			

1. The information presented in this table is to be used in conjunction with the design criteria of ACI 318-14 Chapter 17 or ACI 318-11 Appendix D.

2. The clearance must comply with applicable code requirements for the connected element.

3. The tabulated value of  $\beta$  for  $\frac{1}{4}$ "-diameter carbon steel Strong-Bolt 2 anchor is for installations in uncracked concrete only.

4. The  $\frac{1}{4}$ "-diameter (6.4 mm) anchor may be installed in top of uncracked normal-weight and sand-lightweight concrete over profile steel deck, where concrete thickness above upper flute meets the minimum thickness specified in this table.

5. The  $\frac{3}{8}$ "- through 1"-diameter (9.5 mm through 25.4 mm) anchors may be installed in top of cracked and uncracked normal-weight and sand-lightweight concrete over profile steel deck, where concrete thickness above upper flute meets the minimum thickness specified in this table for  $\frac{5}{8}$ "- through 1"-diameter anchors and in the table on p. 117 for  $\frac{3}{8}$ "- and  $\frac{1}{2}$ "- diameter anchors.

\* See p. 12 for an explanation of the load table icons.

# Strong-Bolt® 2 Design Information — Concrete



## Stainless-Steel Strong-Bolt 2 Installation Information and Additional Data<sup>1</sup>

Characteristic	Symbol	Units	Nominal Anchor Diameter, $d_a$ (in.)									
			$\frac{1}{4}$ <sup>4</sup>	$\frac{3}{8}$ <sup>5</sup>	$\frac{1}{2}$ <sup>5</sup>	$\frac{5}{8}$ <sup>5</sup>	$\frac{3}{4}$ <sup>5</sup>					
<b>Installation Information</b>												
Nominal Diameter	$d_a$	in.	$\frac{1}{4}$	$\frac{3}{8}$	$\frac{1}{2}$	$\frac{5}{8}$	$\frac{3}{4}$					
Drill Bit Diameter	$d$	in.	$\frac{1}{4}$	$\frac{3}{8}$	$\frac{1}{2}$	$\frac{5}{8}$	$\frac{3}{4}$					
Baseplate Clearance Hole Diameter <sup>2</sup>	$d_c$	in.	$\frac{5}{16}$	$\frac{7}{16}$	$\frac{9}{16}$	$\frac{11}{16}$	$\frac{7}{8}$					
Installation Torque	$T_{inst}$	ft-lbf	4	30	65	80	150					
Nominal Embedment Depth	$h_{nom}$	in.	$1\frac{3}{4}$	$1\frac{7}{8}$	$2\frac{1}{8}$	$2\frac{3}{4}$	$3\frac{3}{8}$	$3\frac{1}{2}$	$4\frac{1}{8}$	$4\frac{1}{2}$	$5\frac{1}{4}$	
Effective Embedment Depth	$h_{ef}$	in.	$1\frac{1}{2}$	$1\frac{1}{2}$	$2\frac{1}{2}$	$2\frac{1}{4}$	$3\frac{3}{8}$	$2\frac{3}{4}$	$4\frac{1}{2}$	$3\frac{3}{8}$	5	
Minimum Hole Depth	$h_{hole}$	in.	$1\frac{7}{8}$	2	3	3	$4\frac{1}{8}$	$3\frac{3}{8}$	$5\frac{3}{8}$	$4\frac{3}{8}$	$4\frac{3}{8}$	6
Minimum Overall Anchor Length	$\ell_{anch}$	in.	$2\frac{1}{4}$	$2\frac{3}{4}$	$3\frac{1}{2}$	$3\frac{3}{4}$	$5\frac{1}{2}$	$4\frac{1}{2}$	6	$5\frac{1}{2}$	7	
Critical Edge Distance	$c_{ac}$	in.	$2\frac{1}{2}$	$6\frac{1}{2}$	$8\frac{1}{2}$	$4\frac{1}{2}$	7	$7\frac{1}{2}$	9	8	8	
Minimum Edge Distance	$c_{min}$	in.	$1\frac{3}{4}$	6	$6\frac{1}{2}$	5	4	4	6			
	for $s \geq$	in.	—	10	—	—	8	8	—			
Minimum Spacing	$s_{min}$	in.	$2\frac{1}{4}$	3	8	$5\frac{1}{2}$	4	$6\frac{1}{4}$	$6\frac{1}{2}$			
	for $c \geq$	in.	—	10	—	—	8	$5\frac{1}{2}$	—			
Minimum Concrete Thickness	$h_{min}$	in.	$3\frac{1}{4}$	$3\frac{1}{4}$	$4\frac{1}{2}$	$4\frac{1}{2}$	6	$5\frac{1}{2}$	$7\frac{7}{8}$	$6\frac{3}{4}$	$8\frac{3}{4}$	
<b>Additional Data</b>												
Yield Strength	$f_{ya}$	psi	96,000	80,000	92,000	82,000	68,000					
Tensile Strength	$f_{uta}$	psi	120,000	100,000	115,000	108,000	95,000					
Minimum Tensile and Shear Stress Area	$A_{se}$	in. <sup>2</sup>	0.0255	0.0514	0.105	0.166	0.270					
Axial Stiffness in Service Load Range — Cracked and Uncracked Concrete	$\beta$	lb./in.	54,430 <sup>3</sup>	29,150	54,900	61,270	154,290					

1. The information presented in this table is to be used in conjunction with the design criteria of ACI 318-14 Chapter 17 or ACI 318-11 Appendix D.

2. The clearance must comply with applicable code requirements for the connected element.

3. The tabulated value of  $\beta$  for  $\frac{1}{4}$ "-diameter stainless-steel Strong-Bolt 2 anchor is for installations in uncracked concrete only.

4. The  $\frac{1}{4}$ "-diameter (6.4 mm) anchor may be installed in top of uncracked normal-weight and sand-lightweight concrete over profile steel deck, where concrete thickness above upper flute meets the minimum thickness specified in this table.

5. The  $\frac{3}{8}$ "- through  $\frac{3}{4}$ "-diameter (9.5 mm through 19.1 mm) anchors may be installed in top of cracked and uncracked normal-weight and sand-lightweight concrete over profile steel deck, where concrete thickness above upper flute meets the minimum thickness specified in this table and in the table on p. 117 for the  $\frac{3}{8}$ "- and  $\frac{1}{2}$ "-diameter anchors.

\* See p. 12 for an explanation of the load table icons.



# Strong-Bolt® 2 Design Information — Concrete

## Carbon-Steel Strong-Bolt 2 Tension Strength Design Data<sup>1</sup>



Characteristic	Symbol	Units	Nominal Anchor Diameter, $d_a$ (in.)										
			$\frac{1}{4}^9$	$\frac{3}{8}^9$	$\frac{1}{2}^9$	$\frac{5}{8}^9$	$\frac{3}{4}^9$	$1^9$					
Anchor Category	1, 2 or 3	—	1									2	
Nominal Embedment Depth	$h_{nom}$	in.	1 $\frac{3}{4}$	1 $\frac{7}{8}$	2 $\frac{1}{8}$	2 $\frac{3}{4}$	3 $\frac{1}{8}$	3 $\frac{3}{8}$	3 $\frac{5}{8}$	4 $\frac{1}{8}$	5 $\frac{3}{4}$	5 $\frac{1}{4}$	9 $\frac{3}{4}$
<b>Steel Strength in Tension (ACI 318-14 Section 17.4.1 or ACI 318-11 Section D.5.1)</b>													
Steel Strength in Tension	$N_{sa}$	lb.	2,225	5,600	12,100	19,070	29,700					36,815	
Strength Reduction Factor — Steel Failure <sup>2</sup>	$\phi_{sa}$	—	0.75									0.65	
<b>Concrete Breakout Strength in Tension (ACI 318-14 Section 17.4.2 or ACI 318-11 Section D.5.2)</b>													
Effective Embedment Depth	$h_{ef}$	in.	1 $\frac{1}{2}$	1 $\frac{1}{2}$	2 $\frac{1}{2}$	2 $\frac{1}{4}$	3 $\frac{3}{8}$	2 $\frac{3}{4}$	4 $\frac{1}{2}$	3 $\frac{3}{8}$	5	4 $\frac{1}{2}$	9
Critical Edge Distance	$c_{ac}$	in.	2 $\frac{1}{2}$	6 $\frac{1}{2}$	6	6 $\frac{1}{2}$	7 $\frac{1}{2}$	7 $\frac{1}{2}$	9	9	8	18	13 $\frac{1}{2}$
Effectiveness Factor — Uncracked Concrete	$k_{uncr}$	—	24										
Effectiveness Factor — Cracked Concrete	$k_{cr}$	—	17										
Modification Factor	$\psi_{c,N}$	—	1.00										
Strength Reduction Factor — Concrete Breakout Failure <sup>3</sup>	$\phi_{cb}$	—	0.65									0.55	
<b>Pullout Strength in Tension (ACI 318-14 17.4.3.1 or ACI 318-11 Section D.5.3)</b>													
Pullout Strength, Cracked Concrete ( $f'_c = 2,500$ psi)	$N_{p,cr}$	lb.	— <sup>7</sup>	1,300 <sup>5</sup>	2,775 <sup>5</sup>	N/A <sup>4</sup>	4,985 <sup>5</sup>	N/A <sup>4</sup>	6,895 <sup>5</sup>	N/A <sup>4</sup>	8,500 <sup>5</sup>	7,700 <sup>5</sup>	11,185 <sup>5</sup>
Pullout Strength, Uncracked Concrete ( $f'_c = 2,500$ psi)	$N_{p,uncr}$	lb.	N/A <sup>4</sup>	N/A <sup>4</sup>	3,340 <sup>5</sup>	3,615 <sup>5</sup>	5,255 <sup>5</sup>	N/A <sup>4</sup>	9,025 <sup>5</sup>	7,115 <sup>5</sup>	8,870 <sup>5</sup>	8,360 <sup>5</sup>	9,690 <sup>5</sup>
Strength Reduction Factor — Pullout Failure <sup>6</sup>	$\phi_p$	—	0.65									0.55	
<b>Tensile Strength for Seismic Applications (ACI 318-14 Section 17.2.3.3 or ACI 318-11 Section D3.3.3)</b>													
Nominal Pullout Strength for Seismic Loads ( $f'_c = 2,500$ psi)	$N_{p,eq}$	lb.	— <sup>7</sup>	1,300 <sup>5</sup>	2,775 <sup>5</sup>	N/A <sup>4</sup>	4,985 <sup>5</sup>	N/A <sup>4</sup>	6,895 <sup>5</sup>	N/A <sup>4</sup>	8,500 <sup>5</sup>	7,700 <sup>5</sup>	11,185 <sup>5</sup>
Strength Reduction Factor — Pullout Failure <sup>6</sup>	$\phi_{eq}$	—	0.65									0.55	

- The information presented in this table must be used in conjunction with the design criteria of ACI 318-14 Chapter 17 or ACI 318-11 Appendix D, as applicable, except as modified below.
- The tabulated value of  $\phi_{sa}$  applies when the load combinations of Section 1605.2.1 of the IBC, ACI 318-14 Section 5.3 or ACI 318-11 Section 9.2 are used. If the load combinations of ACI 318-11 Appendix C are used, the appropriate value of  $\phi_{sa}$  must be determined in accordance with ACI 318-11 D.4.4.
- The tabulated value of  $\phi_{cb}$  applies when both the load combinations of Section 1605.2.1 of the IBC, ACI 318-14 Section 5.3 or ACI 318-11 Section 9.2 are used and the requirements of ACI 318-14 17.3.3(c) or ACI 318-11 D.4.3(c) for Condition B are met. Condition B applies where supplementary reinforcement is not provided. For installations where complying supplementary reinforcement can be verified, the  $\phi_{cb}$  factors described in ACI 318-14 17.3.3(c) or ACI 318-11 D.4.3(c) for Condition A are allowed. If the load combinations of ACI 318-11 Appendix C are used, the appropriate value of  $\phi_{cb}$  must be determined in accordance with ACI 318-11 D.4.4(c).
- N/A (not applicable) denotes that pullout resistance does not need to be considered.
- The characteristic pullout strength for greater concrete compressive strengths shall be increased by multiplying the tabular value by  $(f'_c/2,500 \text{ psi})^{0.5}$ .
- The tabulated value of  $\phi_p$  or  $\phi_{eq}$  applies when the load combinations of Section 1605.2.1 of the IBC, ACI 318-14 Section 5.3 or ACI 318-11 Section 9.2 are used and the requirements of ACI 318-14 17.3.3(c) or ACI 318-11 D.4.3(c) for Condition B are met. If the load combinations of ACI 318-11 Appendix C are used, appropriate value of  $\phi$  must be determined in accordance with ACI 318-11 Section D.4.4(c).
- The  $\frac{1}{4}$ "-diameter carbon steel Strong-Bolt 2 anchor installation in cracked concrete is beyond the scope of this table.
- The  $\frac{1}{4}$ "-diameter (6.4 mm) anchor may be installed in top of uncracked normal-weight and sand-lightweight concrete over profile steel deck, where concrete thickness above upper flute meets the minimum thickness specified in the table on p. 111.
- The  $\frac{3}{8}$ "- through 1"-diameter (9.5 mm through 25.4 mm) anchors may be installed in top of cracked and uncracked normal-weight and sand-lightweight concrete over profile steel deck, where concrete thickness above upper flute meets the minimum thickness specified in the table on p. 111 and in the table on p. 117 for the  $\frac{3}{8}$ "- and  $\frac{1}{2}$ "-diameter anchors.

\* See p. 12 for an explanation of the load table icons.

## Strong-Bolt® 2 Design Information — Concrete

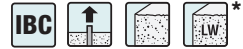
Stainless-Steel Strong-Bolt 2 Tension Strength Design Data<sup>1</sup>

Characteristic	Symbol	Units	Nominal Anchor Diameter, $d_a$ (in.)								
			1/4"	3/8"	1/2"	5/8"	3/4"	1"	1 1/8"	1 1/4"	1 1/2"
Anchor Category	1, 2 or 3	—	1								
Nominal Embedment Depth	$h_{nom}$	in.	1 3/4	1 7/8	2 7/8	2 3/4	3 7/8	3 3/8	5 1/8	4 1/8	5 3/4
<b>Steel Strength in Tension (ACI 318-14 Section 17.4.1 or ACI 318-11 Section D5.1)</b>											
Steel Strength in Tension	$N_{sa}$	lb.	3,060	5,140	12,075	17,930	25,650				
Strength Reduction Factor — Steel Failure <sup>2</sup>	$\phi_{sa}$	—	0.75								
<b>Concrete Breakout Strength in Tension (ACI 318-14 Section 17.4.2 or ACI 318-11 Section D5.2)</b>											
Effective Embedment Depth	$h_{ef}$	in.	1 1/2	1 1/2	2 1/2	2 1/4	3 3/8	2 3/4	4 1/2	3 3/8	5
Critical Edge Distance	$c_{ac}$	in.	2 1/2	6 1/2	8 1/2	4 1/2	7	7 1/2	9	8	8
Effectiveness Factor — Uncracked Concrete	$k_{uncr}$	—	24								
Effectiveness Factor — Cracked Concrete	$k_{cr}$	—	— <sup>9</sup>	17							
Modification Factor	$\psi_{c,N}$	—	— <sup>9</sup>	1.00							
Strength Reduction Factor — Concrete Breakout Failure <sup>3</sup>	$\phi_{cb}$	—	0.65								
<b>Pullout Strength in Tension (ACI 318-14 Section 17.4.3 or ACI 318-11 Section D5.3)</b>											
Pullout Strength, Cracked Concrete ( $f'_c = 2,500$ psi)	$N_{p,cr}$	lb.	— <sup>9</sup>	1,720 <sup>6</sup>	3,145 <sup>6</sup>	2,560 <sup>5</sup>	4,305 <sup>5</sup>	N/A <sup>4</sup>	6,545 <sup>7</sup>	N/A <sup>4</sup>	8,230 <sup>5</sup>
Pullout Strength, Uncracked Concrete ( $f'_c = 2,500$ psi)	$N_{p,uncr}$	lb.	1,925 <sup>7</sup>	N/A <sup>4</sup>	4,770 <sup>6</sup>	3,230 <sup>5</sup>	4,495 <sup>5</sup>	N/A <sup>4</sup>	7,615 <sup>5</sup>	7,725 <sup>7</sup>	9,625 <sup>7</sup>
Strength Reduction Factor — Pullout Failure <sup>8</sup>	$\phi_p$	—	0.65								
<b>Tensile Strength for Seismic Applications (ACI 318-14 Section 17.2.3.3 or ACI 318-11 Section D.3.3.3)</b>											
Nominal Pullout Strength for Seismic Loads ( $f'_c = 2,500$ psi)	$N_{p,eq}$	lb.	— <sup>9</sup>	1,720 <sup>6</sup>	2,830 <sup>6</sup>	2,560 <sup>5</sup>	4,305 <sup>5</sup>	N/A <sup>4</sup>	6,545 <sup>7</sup>	N/A <sup>4</sup>	8,230 <sup>5</sup>
Strength Reduction Factor — Pullout Failure <sup>8</sup>	$\phi_{eq}$	—	0.65								

- The information presented in this table must be used in conjunction with the design criteria of ACI 318-14 Chapter 17 or ACI 318-11 Appendix D, as applicable, except as modified below.
- The tabulated value of  $\phi_{sa}$  applies when the load combinations of Section 1605.2.1 of the IBC, ACI 318-14 Section 5.3 or ACI 318-11 Section 9.2 are used. If the load combinations of ACI 318-11 Appendix C are used, the appropriate value of  $\phi_{sa}$  must be determined in accordance with ACI 318-11 D.4.4.
- The tabulated value of  $\phi_{cb}$  applies when both the load combinations of Section 1605.2.1 of the IBC, ACI 318-14 Section 5.3 or ACI 318-11 Section 9.2 are used and the requirements of ACI 318-14 17.3.3(c) or ACI 318-11 D.4.3(c) for Condition B are met. Condition B applies where supplementary reinforcement is not provided. For installations where complying supplementary reinforcement can be verified, the  $\phi_{cb}$  factors described in ACI 318-14 17.3.3(c) or ACI 318-11 D.4.3(c) for Condition A are allowed. If the load combinations of ACI 318-11 Appendix C are used, the appropriate value of  $\phi_{cb}$  must be determined in accordance with ACI 318-11 D.4.4(c).
- N/A (not applicable) denotes that pullout resistance does not need to be considered.
- The characteristic pullout strength for greater concrete compressive strengths shall be increased by multiplying the tabular value by  $(f'_c/2,500 \text{ psi})^{0.5}$ .
- The characteristic pullout strength for greater concrete compressive strengths shall be increased by multiplying the tabular value by  $(f'_c/2,500 \text{ psi})^{0.3}$ .
- The characteristic pullout strength for greater concrete compressive strengths shall be increased by multiplying the tabular value by  $(f'_c/2,500 \text{ psi})^{0.4}$ .
- The tabulated value of  $\phi_p$  or  $\phi_{eq}$  applies when the load combinations of Section 1605.2.1 of the IBC, ACI 318-14 Section 5.3 or ACI 318-11 Section 9.2 are used and the requirements of ACI 318-14 17.3.3(c) or ACI 318-11 D.4.3(c) for Condition B are met. If the load combinations of ACI 318-11 Appendix C are used, appropriate value of  $\phi$  must be determined in accordance with ACI 318-11 Section D.4.4(c).
- The 1/4"-diameter stainless-steel Strong-Bolt 2 anchor installation in cracked concrete is beyond the scope of this table.
- The 1/4"-diameter (6.4 mm) anchor may be installed in top of uncracked normal-weight and sand-lightweight concrete over profile steel deck, where concrete thickness above upper flute meets the minimum thickness specified in the table on p. 112.
- The 3/8"- through 3/4"-diameter (9.5 mm through 19.1 mm) anchors may be installed in top of cracked and uncracked normal-weight and sand-lightweight concrete over profile steel deck, where concrete thickness above upper flute meets the minimum thickness specified in the table on p. 112 and in the table on p. 117 for the 3/8"- and 1/2"-diameter anchors.

\* See p. 12 for an explanation of the load table icons.

## Strong-Bolt® 2 Design Information — Concrete

Carbon-Steel Strong-Bolt 2 Shear Strength Design Data<sup>1</sup>

Characteristic	Symbol	Units	Nominal Anchor Diameter, $d_a$ (in.)										
			$\frac{1}{4}^6$	$\frac{3}{8}^7$	$\frac{1}{2}^7$	$\frac{5}{8}^7$	$\frac{3}{4}^7$	$1^7$					
Anchor Category	1, 2 or 3	—	1									2	
Nominal Embedment Depth	$h_{nom}$	in.	$1\frac{3}{4}$	$1\frac{7}{8}$	$2\frac{7}{8}$	$2\frac{3}{4}$	$3\frac{7}{8}$	$3\frac{3}{8}$	$5\frac{1}{8}$	$4\frac{1}{8}$	$5\frac{3}{4}$	$5\frac{1}{4}$	$9\frac{3}{4}$
<b>Steel Strength in Shear (ACI 318-14 Section 17.5.1.1 or ACI 318-11 Section D.6.1)</b>													
Steel Strength in Shear	$V_{sa}$	lb.	965	1,800	7,235	11,035	14,480	15,020					
Strength Reduction Factor — Steel Failure <sup>2</sup>	$\phi_{sa}$	—	0.65									0.60	
<b>Concrete Breakout Strength in Shear (ACI 318-14 Section 17.5.2 or ACI 318-11 Section D.6.2)</b>													
Outside Diameter	$d_a$	in.	0.25	0.375	0.500	0.625	0.750	1.00					
Load-Bearing Length of Anchor in Shear	$\ell_e$	in.	1.500	1.500	2.500	2.250	3.375	2.750	4.500	3.375	5.000	4.500	8.000
Strength Reduction Factor — Concrete Breakout Failure <sup>2</sup>	$\phi_{cb}$	—	0.70										
<b>Concrete Pryout Strength in Shear (ACI 318-14 Section 17.5.3 or ACI 318-11 Section D.6.3)</b>													
Coefficient for Pryout Strength	$k_{cp}$	—	1.0	2.0	1.0	2.0							
Effective Embedment Depth	$h_{ef}$	in.	$1\frac{1}{2}$	$1\frac{1}{2}$	$2\frac{1}{2}$	$2\frac{1}{4}$	$3\frac{3}{8}$	$2\frac{3}{4}$	$4\frac{1}{2}$	$3\frac{3}{8}$	5	$4\frac{1}{2}$	9
Strength Reduction Factor — Concrete Pryout Failure <sup>4</sup>	$\phi_{cp}$	—	0.70										
<b>Steel Strength in Shear for Seismic Applications (ACI 315-14 Section 17.2.3.3 or ACI 318-11 Section D.3.3.3)</b>													
Shear Strength of Single Anchor for Seismic Loads ( $f'_c = 2,500$ psi)	$V_{sa,eq}$	lb.	— <sup>5</sup>	1,800	6,510	9,930	11,775	15,020					
Strength Reduction Factor — Steel Failure <sup>2</sup>	$\phi_{eq}$	—	0.65									0.60	

- The information presented in this table must be used in conjunction with the design criteria of ACI 318-14 Chapter 17 or ACI 318-11 Appendix D, except as modified below.
- The tabulated value of  $\phi_{sa}$  or  $\phi_{sa,eq}$  applies when the load combinations of Section 1605.2.1 of the IBC, ACI 318-14 Section 5.3 or ACI 318-11 Section 9.2 are used. If the load combinations of ACI 318-11 Appendix C are used, the appropriate value of  $\phi_{sa}$  or  $\phi_{sa,eq}$  must be determined in accordance with ACI 318 D.4.4.
- The tabulated value of  $\phi_{cb}$  applies when both the load combinations of Section 1605.2.1 of the IBC, ACI 318-14 Section 5.3 or ACI 318-11 Section 9.2 are used and the requirements of ACI 318-14 17.3.3(c) or ACI 318-11 D.4.3(c) for Condition B are met. Condition B applies where supplementary reinforcement is not provided. For installations where complying supplementary reinforcement can be verified, the  $\phi_{cb}$  factors described in ACI 318-14 17.3.3(c) or ACI 318-11 D.4.3(c) for Condition A are allowed. If the load combinations of ACI 318-11 Appendix C are used, the appropriate value of  $\phi_{cb}$  must be determined in accordance with ACI 318-11 D.4.4(c).
- The tabulated value of  $\phi_{cp}$  applies when both the load combinations of IBC Section 1605.2, ACI 318-14 5.3 or ACI 318-11 Section 9.2 are used and the requirements of ACI 318-14 17.3.3(c) or ACI 318-11 D.4.3(c) for Condition B are met. If the load combinations of ACI 318-11 Appendix C are used, appropriate value of  $\phi_{cp}$  must be determined in accordance with ACI 318-11 Section D.4.4(c).
- The  $\frac{1}{4}$ "-diameter carbon steel Strong-Bolt 2 anchor installation in cracked concrete is beyond the scope of this table.
- The  $\frac{1}{4}$ "-diameter (6.4 mm) anchor may be installed in top of uncracked normal-weight and sand-lightweight concrete over profile steel deck, where concrete thickness above upper flute meets the minimum thickness specified in the table on p. 111.
- The  $\frac{3}{8}$ "- through 1"-diameter (9.5 mm through 25.4 mm) anchors may be installed in top of cracked and uncracked normal-weight and sand-lightweight concrete over profile steel deck, where concrete thickness above upper flute meets the minimum thickness specified in the table on p. 117.

\* See p. 12 for an explanation of the load table icons.

# Strong-Bolt® 2 Design Information — Concrete

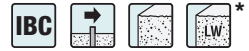

## Stainless-Steel Strong-Bolt 2 Shear Strength Design Data<sup>1</sup>

Characteristic	Symbol	Units	Nominal Anchor Diameter, $d_a$ (in.)								
			$\frac{1}{4}$ <sup>6</sup>	$\frac{3}{8}$ <sup>7</sup>	$\frac{1}{2}$ <sup>7</sup>	$\frac{5}{8}$ <sup>7</sup>	$\frac{3}{4}$ <sup>7</sup>	$\frac{7}{8}$ <sup>7</sup>	$1$ <sup>7</sup>	$1\frac{1}{8}$ <sup>7</sup>	$1\frac{1}{4}$ <sup>7</sup>
Anchor Category	1, 2 or 3	—	1								
Nominal Embedment Depth	$h_{nom}$	in.	1 $\frac{3}{4}$	1 $\frac{7}{8}$	2 $\frac{7}{8}$	2 $\frac{3}{4}$	3 $\frac{7}{8}$	3 $\frac{3}{8}$	5 $\frac{1}{8}$	4 $\frac{1}{8}$	5 $\frac{1}{4}$
<b>Steel Strength in Shear (ACI 318-14 Section 17.5.1 or ACI 318-11 Section D.6.1)</b>											
Steel Strength in Shear	$V_{sa}$	lb.	1,605	3,085	7,245	6,745	10,760	15,045			
Strength Reduction Factor — Steel Failure <sup>2</sup>	$\phi_{sa}$	—	0.65								
<b>Concrete Breakout Strength in Shear (ACI 318-14 Section 17.5.2 or ACI 318-11 Section D.6.2)</b>											
Outside Diameter	$d_a$	in.	0.250	0.375	0.500	0.625	0.750				
Load Bearing Length of Anchor in Shear	$\ell_e$	in.	1.500	1.500	2.500	2.250	3.375	2.750	4.500	3.375	5.000
Strength Reduction Factor — Concrete Breakout Failure <sup>3</sup>	$\phi_{cb}$	—	0.70								
<b>Concrete Pryout Strength in Shear (ACI 318-14 Section 17.5.2 or ACI 318-11 Section D.6.3)</b>											
Coefficient for Pryout Strength	$k_{cp}$	—	1.0	2.0	1.0	2.0					
Effective Embedment Depth	$h_{ef}$	in.	1 $\frac{1}{2}$	1 $\frac{1}{2}$	2 $\frac{1}{2}$	2 $\frac{1}{4}$	3 $\frac{3}{8}$	2 $\frac{3}{4}$	4 $\frac{1}{2}$	3 $\frac{3}{8}$	5
Strength Reduction Factor — Concrete Pryout Failure <sup>4</sup>	$\phi_{cp}$	—	0.70								
<b>Steel Strength in Shear for Seismic Applications (ACI 318-14 Section 17.2.3.3 or ACI 318-11 Section D.3.3.3)</b>											
Shear Strength of Single Anchor for Seismic Loads ( $f'_c = 2,500$ psi)	$V_{sa,eq}$	lb.	— <sup>5</sup>	3,085	6,100	6,745	10,760	13,620			
Strength Reduction Factor — Steel Failure <sup>2</sup>	$\phi_{sa}$	—	0.65								

- The information presented in this table must be used in conjunction with the design criteria of ACI 318-14 Chapter 17 or ACI 318-11 Appendix D, except as modified below.
- The tabulated value of  $\phi_{sa}$  applies when the load combinations of Section 1605.2.1 of the IBC, ACI 318-14 Section 5.3 or ACI 318-11 Section 9.2 are used. If the load combinations of ACI 318-11 Appendix C are used, the appropriate value of  $\phi_{sa}$  must be determined in accordance with ACI 318 D.4.4.
- The tabulated value of  $\phi_{cb}$  applies when both the load combinations of Section 1605.2.1 of the IBC, ACI 318-14 Section 5.3 or ACI 318-11 Section 9.2 are used and the requirements of ACI 318-14 17.3.3(c) or ACI 318-11 D.4.3(c) for Condition B are met. Condition B applies where supplementary reinforcement is not provided. For installations where complying supplementary reinforcement can be verified, the  $\phi_{cb}$  factors described in ACI 318-14 17.3.3(c) or ACI 318-11 D.4.3(c) for Condition A are allowed. If the load combinations of ACI 318-11 Appendix C are used, the appropriate value of  $\phi_{cb}$  must be determined in accordance with ACI 318-11 D.4.4(c).
- The tabulated value of  $\phi_{cp}$  applies when both the load combinations of IBC Section 1605.2, ACI 318-14 5.3 or ACI 318-11 Section 9.2 are used and the requirements of ACI 318-14 17.3.3(c) or ACI 318-11 D.4.3(c) for Condition B are met. If the load combinations of ACI 318-11 Appendix C are used, appropriate value of  $\phi_{cp}$  must be determined in accordance with ACI 318-11 Section D.4.4(c).
- The  $\frac{1}{4}$ "-diameter stainless-steel Strong-Bolt 2 anchor installation in cracked concrete is beyond the scope of this table.
- The  $\frac{1}{4}$ "-diameter (6.4 mm) anchor may be installed in top of uncracked normal-weight and sand-lightweight concrete over profile steel deck, where concrete thickness above upper flute meets the minimum thickness specified in the table on p. 112.
- The  $\frac{3}{8}$ "- through  $\frac{3}{4}$ "-diameter (9.5 mm through 19.1 mm) anchors may be installed in top of cracked and uncracked normal-weight and sand-lightweight concrete over profile steel deck, where concrete thickness above upper flute meets the minimum thickness specified in the table on p. 117.

<sup>\*</sup> See p. 12 for an explanation of the load table icons.

# Strong-Bolt® 2 Design Information — Concrete

Carbon-Steel Strong-Bolt 2 Information for Installation in the Topside of Concrete-Filled Profile Steel Deck Floor and Roof Assemblies<sup>1,2,3,4</sup>



Design Information	Symbol	Units	Nominal Anchor Diameter (in.)	
			3/8	1/2
Nominal Embedment Depth	$h_{nom}$	in.	1 7/8	2 3/4
Effective Embedment Depth	$h_{ef}$	in.	1 1/2	2 1/4
Minimum Concrete Thickness <sup>5</sup>	$h_{min,deck}$	in.	2 1/2	3 1/4
Critical Edge Distance	$c_{ac,deck,top}$	in.	4 3/4	4
Minimum Edge Distance	$c_{min,deck,top}$	in.	4 3/4	4 1/2
Minimum Spacing	$s_{min,deck,top}$	in.	7	6 1/2

- For **SI**: 1 inch = 25.4 mm; 1 lbf = 4.45N
1. Installation must comply with the table on p. 111 and Figure 1 below.
  2. Design capacity shall be based on calculations according to values in the tables on pp. 113 and 115.
  3. Minimum flute depth (distance from top of flute to bottom of flute) is 1 1/2".
  4. Steel deck thickness shall be a minimum 20 gauge.
  5. Minimum concrete thickness ( $h_{min,deck}$ ) refers to concrete thickness above upper flute.

Stainless-Steel Strong-Bolt 2 Information for Installation in the Topside of Concrete-Filled Profile Steel Deck Floor and Roof Assemblies<sup>1,2,3,4</sup>



Design Information	Symbol	Units	Nominal Anchor Diameter (in.)	
			3/8	1/2
Nominal Embedment Depth	$h_{nom}$	in.	1 7/8	2 3/4
Effective Embedment Depth	$h_{ef}$	in.	1 1/2	2 1/4
Minimum Concrete Thickness <sup>5</sup>	$h_{min,deck}$	in.	2 1/2	3 1/4
Critical Edge Distance	$c_{ac,deck,top}$	in.	4 3/4	4
Minimum Edge Distance	$c_{min,deck,top}$	in.	4 3/4	6
Minimum Spacing	$s_{min,deck,top}$	in.	6 1/2	8

- For **SI**: 1 inch = 25.4 mm; 1 lbf = 4.45N
1. Installation must comply with the table on p. 112 and Figure 1 below.
  2. Design capacity shall be based on calculations according to values in the tables on pp. 114 and 116.
  3. Minimum flute depth (distance from top of flute to bottom of flute) is 1 1/2".
  4. Steel deck thickness shall be a minimum 20 gauge.
  5. Minimum concrete thickness ( $h_{min,deck}$ ) refers to concrete thickness above upper flute.

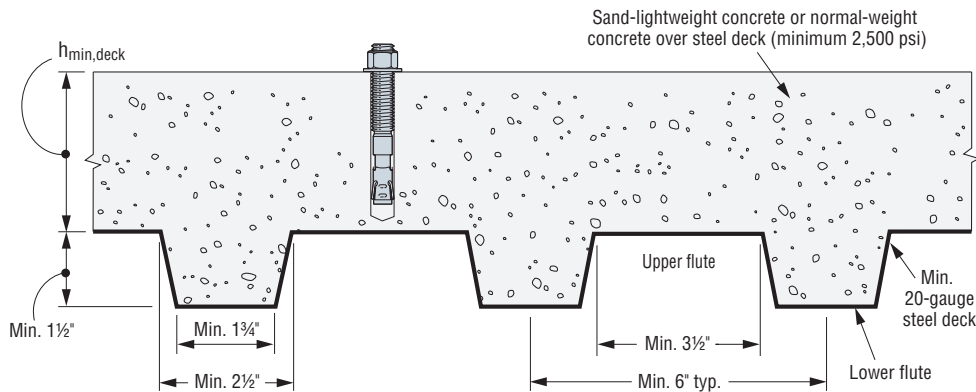

Figure 1

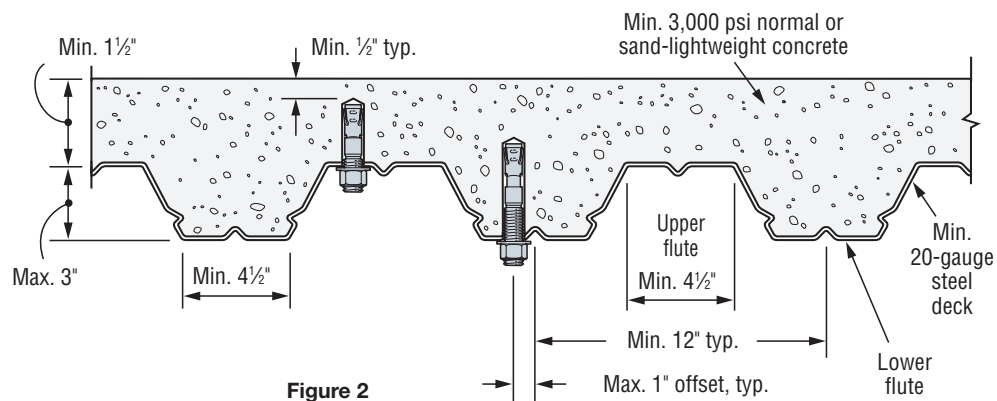

Figure 2

\* See p. 12 for an explanation of the load table icons.

## Strong-Bolt® 2 Design Information — Concrete

Carbon-Steel Strong-Bolt 2 Tension and Shear Strength Design Data  
for the Soffit of Concrete over Steel Deck Floor and Roof Assemblies<sup>1,2,6,8,9</sup>

Characteristic	Symbol	Units	Nominal Anchor Diameter (in.)								
			Carbon Steel								
			Lower Flute						Upper Flute		
			¾	½	¾	¾	¾	¾	¾	½	
Nominal Embedment Depth	$h_{nom}$	in.	2	3¾	2¾	4½	3¾	5¾	4¾	2	2¾
Effective Embedment Depth	$h_{ef}$	in.	1¾	3	2¼	4	2¾	5	3¾	1¾	2¼
Installation Torque	$T_{inst}$	ft.-lbf.	30		60		90		150	30	60
Pullout Strength, concrete on steel deck (cracked) <sup>3,4</sup>	$N_{p,deck,cr}$	lb.	1,040 <sup>7</sup>	2,615 <sup>7</sup>	2,040 <sup>7</sup>	3,645 <sup>7</sup>	2,615 <sup>7</sup>	4,990 <sup>7</sup>	2,815 <sup>7</sup>	1,340 <sup>7</sup>	3,785 <sup>7</sup>
Pullout Strength, concrete on steel deck (uncracked) <sup>3,4</sup>	$N_{p,deck,uncr}$	lb.	1,765 <sup>7</sup>	3,150 <sup>7</sup>	2,580 <sup>7</sup>	3,840 <sup>7</sup>	3,685 <sup>7</sup>	6,565 <sup>7</sup>	3,800 <sup>7</sup>	2,275 <sup>7</sup>	4,795 <sup>7</sup>
Pullout Strength, concrete on steel deck (seismic) <sup>3,4</sup>	$N_{p,deck,eq}$	lb.	1,040 <sup>7</sup>	2,615 <sup>7</sup>	2,040 <sup>7</sup>	3,645 <sup>7</sup>	2,615 <sup>7</sup>	4,990 <sup>7</sup>	2,815 <sup>7</sup>	1,340 <sup>7</sup>	3,785 <sup>7</sup>
Steel Strength in Shear, concrete on steel deck <sup>5</sup>	$V_{sa,deck}$	lb.	1,595	3,490	2,135	4,580	2,640	7,000	4,535	3,545	5,920
Steel Strength in Shear, concrete on steel deck (seismic) <sup>5</sup>	$V_{sa,deck,eq}$	lb.	1,595	3,490	1,920	4,120	2,375	6,300	3,690	3,545	5,330

- The information presented in this table must be used in conjunction with the design criteria of ACI 318-14 Chapter 17 or ACI 318-11 Appendix D, except as modified below.
- The steel deck profile must comply with the configuration in Figure 2 on the previous page, and have a minimum base-steel thickness of 0.035 inch (20 gauge). Steel must comply with ASTM A 653/A 653M SS Grade 33 with minimum yield strength of 33,000 psi. Concrete compressive strength shall be 3,000 psi minimum.
- For anchors installed in the soffit of sand-lightweight or normal-weight concrete over steel deck floor and roof assemblies, calculation of the concrete breakout strength may be omitted.
- In accordance with ACI 318-14 Section 17.4.3.2 or ACI 318-11 Section D.5.3.2, the nominal pullout strength in cracked concrete for anchors installed in the soffit of sand-lightweight or normal-weight concrete over steel deck floor and roof assemblies  $N_{p,deck,cr}$  shall be substituted for  $N_{p,cr}$ . Where analysis indicates no cracking at service loads, the normal pullout strength in uncracked concrete  $N_{p,deck,uncr}$  shall be substituted for  $N_{p,uncr}$ . For seismic loads,  $N_{p,deck,eq}$  shall be substituted for  $N_{p,e}$ .
- In accordance with ACI 318-14 Section 17.5.1.2(C) or ACI 318-11 Section D.6.1.2(c), the shear strength for anchors installed in the soffit of sand-lightweight or normal-weight concrete over steel deck floor and roof assemblies  $V_{sa,deck}$  shall be substituted for  $V_{sa}$ . For seismic loads,  $V_{sa,deck,eq}$  shall be substituted for  $V_{sa,e}$ .
- The minimum anchor spacing along the flute must be the greater of  $3.0h_{ef}$  or 1.5 times the flute width.
- The characteristic pull-out strength for greater concrete compressive strengths shall be increased by multiplying the tabular value by  $(f'_c / 3,000 \text{ psi})^{0.5}$ .
- Concrete shall be normal-weight or structural sand-lightweight concrete having a minimum specified compressive strength,  $f'_c$ , of 3,000 psi.
- Minimum distance to edge of panel is  $2h_{ef}$ .

\* See p. 12 for an explanation of the load table icons.

# Strong-Bolt® 2 Design Information — Concrete

Stainless-Steel Strong-Bolt 2 Tension and Shear Strength Design Data for the Soffit of Concrete over Steel Deck Floor and Roof Assemblies<sup>1,2,6,10,11</sup>



Characteristic	Symbol	Units	Stainless Steel								
			Lower Flute						Upper Flute		
			¾		½		⅝		¾	¾	½
Nominal Embedment Depth	$h_{nom}$	in.	2	3¾	2¾	4½	3¾	5¾	4½	2	2¾
Effective Embedment Depth	$h_{ef}$	in.	1¾	3	2¼	4	2¾	5	3¾	1¾	2¼
Installation Torque	$T_{inst}$	ft.-lbf.	30		65		80		150	30	65
Pullout Strength, concrete on steel deck (cracked) <sup>3</sup>	$N_{p,deck,cr}$	lb.	1,230 <sup>8</sup>	2,605 <sup>8</sup>	1,990 <sup>7</sup>	2,550 <sup>7</sup>	1,750 <sup>9</sup>	4,020 <sup>9</sup>	3,030 <sup>7</sup>	1,550 <sup>8</sup>	2,055 <sup>7</sup>
Pullout Strength, concrete on steel deck (uncracked) <sup>3</sup>	$N_{p,deck,uncr}$	lb.	1,580 <sup>8</sup>	3,950 <sup>8</sup>	2,475 <sup>7</sup>	2,660 <sup>7</sup>	2,470 <sup>7</sup>	5,000 <sup>7</sup>	4,275 <sup>9</sup>	1,990 <sup>8</sup>	2,560 <sup>7</sup>
Pullout Strength, concrete on steel deck (seismic) <sup>5</sup>	$N_{p,deck,eq}$	lb.	1,230 <sup>8</sup>	2,345 <sup>8</sup>	1,990 <sup>7</sup>	2,550 <sup>7</sup>	1,750 <sup>9</sup>	4,020 <sup>9</sup>	3,030 <sup>7</sup>	1,550 <sup>8</sup>	2,055 <sup>7</sup>
Steel Strength in Shear, concrete on steel deck <sup>4</sup>	$V_{sa,deck}$	lb.	2,285	3,085	3,430	4,680	3,235	5,430	6,135	3,085	5,955
Steel Strength in Shear, concrete on steel deck (seismic) <sup>5</sup>	$V_{sa,deck,eq}$	lb.	2,285	3,085	2,400	3,275	3,235	5,430	5,520	3,085	4,170

- The information presented in this table must be used in conjunction with the design criteria of ACI 318-14 Chapter 17 or ACI 318-11 Appendix D, except as modified below.
- The steel deck profile must comply with the configuration in Figure 2 on the previous page, and have a minimum base-steel thickness of 0.035 inch (20 gauge). Steel must comply with ASTM A 653/A 653M SS Grade 33 with minimum yield strength of 33,000 psi. Concrete compressive strength shall be 3,000 psi minimum.
- For anchors installed in the soffit of sand-lightweight or normal-weight concrete over steel deck floor and roof assemblies, calculation of the concrete breakout strength may be omitted.
- In accordance with ACI 318-14 Section 17.4.3.2 or ACI 318-11 Section D.5.3.2, the nominal pullout strength in cracked concrete for anchors installed in the soffit of sand-lightweight or normal-weight concrete over steel deck floor and roof assemblies  $N_{p,deck,cr}$  shall be substituted for  $N_{p,cr}$ . Where analysis indicates no cracking at service loads, the normal pullout strength in uncracked concrete  $N_{p,deck,uncr}$  shall be substituted for  $N_{p,uncr}$ . For seismic loads,  $N_{p,deck,eq}$  shall be substituted for  $N_{p,cr}$ .
- In accordance with ACI 318-14 Section 17.5.1.2(C) or ACI 318-11 Section D.6.1.2(c), the shear strength for anchors installed in the soffit of sand-lightweight or normal-weight concrete over steel deck floor and roof assemblies  $V_{sa,deck}$  shall be substituted for  $V_{sa}$ . For seismic loads,  $V_{sa,deck,eq}$  shall be substituted for  $V_{sa}$ .
- The minimum anchor spacing along the flute must be the greater of  $3.0h_{ef}$  or 1.5 times the flute width.
- The characteristic pull-out strength for greater concrete compressive strengths shall be increased by multiplying the tabular value by  $(f'_c / 3,000 \text{ psi})^{0.5}$ .
- The characteristic pull-out strength for greater concrete compressive strengths shall be increased by multiplying the tabular value by  $(f'_c / 3,000 \text{ psi})^{0.3}$ .
- The characteristic pull-out strength for greater concrete compressive strengths shall be increased by multiplying the tabular value by  $(f'_c / 3,000 \text{ psi})^{0.4}$ .
- Concrete shall be normal-weight or structural sand-lightweight concrete having a minimum specified compressive strength,  $f'_c$ , of 3,000 psi.
- Minimum distance to edge of panel is  $2h_{ef}$ .

Mechanical Anchors

\* See p. 12 for an explanation of the load table icons.

# Strong-Bolt® 2 Design Information — Concrete

Carbon-Steel Strong-Bolt 2 Anchor Tension and Shear Strength Design Data for the Soffit of Concrete over Steel Deck, Floor and Roof Assemblies<sup>1,2,6,8,9</sup>



Mechanical Anchors

Characteristic	Symbol	Units	Carbon Steel Nominal Anchor Diameter (in.)					
			Installed in Lower Flute					
			3/8	1/2	5/8	3/4	1	1 1/8
Nominal Embedment Depth	$h_{nom}$	in.	2	3 3/8	2 3/4	4 1/2	3 3/8	5 5/8
Effective Embedment Depth	$h_{ef}$	in.	1 5/8	3	2 1/4	4	2 3/4	5
Minimum Hole Depth	$h_{hole}$	in.	2 1/8	3 1/2	3	4 3/4	3 5/8	5 5/8
Minimum Concrete Thickness	$h_{min,deck}$	in.	2	2	2	3 1/4	2	3 1/4
Installation Torque	$T_{inst}$	ft.-lbf.	30		60		90	
Pullout Strength, concrete on steel deck (cracked) <sup>3,4,7</sup>	$N_{p,deck,cr}$	lb.	1,295	2,705	2,585	5,850	3,015	5,120
Pullout Strength, concrete on steel deck (uncracked) <sup>3,4,7</sup>	$N_{p,deck,uncr}$	lb.	2,195	3,260	3,270	6,165	4,250	6,735
Pullout Strength, concrete on steel deck (seismic) <sup>3,4,7</sup>	$N_{p,deck,eq}$	lb.	1,295	2,705	2,585	5,850	3,015	5,120
Steel Strength in Shear, concrete on steel deck <sup>5</sup>	$V_{sa,deck}$	lb.	1,535	3,420	2,785	5,950	3,395	6,745
Steel Strength in Shear, concrete on steel deck (seismic) <sup>5</sup>	$V_{sa,deck,eq}$	lb.	1,535	3,420	2,505	5,350	3,055	6,070

- The information presented in this table must be used in conjunction with the design criteria of ACI 318-14 Chapter 17 or ACI 318-11 Appendix D, except as modified below.
- The steel deck profile must comply with the configuration in Figure 3 below, and have a minimum base-steel thickness of 0.035 inch (20 gauge). Steel must comply with ASTM A 653/A 653M SS Grade 50 with minimum yield strength of 50,000 psi. Concrete compressive strength shall be 3,000 psi minimum.
- For anchors installed in the soffit of sand-lightweight or normal-weight concrete over steel deck floor and roof assemblies, calculation of the concrete breakout strength may be omitted.
- In accordance with ACI 318-14 Section 17.4.3.2 or ACI 318-11 Section D.5.3.2, the nominal pullout strength in cracked concrete for anchors installed in the soffit of sand-lightweight or normal-weight concrete over steel deck floor and roof assemblies  $N_{p,deck,cr}$  shall be substituted for  $N_{p,cr}$ . Where analysis indicates no cracking at service loads, the normal pullout strength in uncracked concrete  $N_{p,deck,uncr}$  shall be substituted for  $N_{p,uncr}$ . For seismic loads,  $N_{p,deck,eq}$  shall be substituted for  $N_{p}$ .
- In accordance with ACI 318-14 Section 17.5.1.2(c) or ACI 318-11, the shear strength for anchors installed in the soffit of sand-lightweight or normal-weight concrete over steel deck floor and roof assemblies  $V_{sa,deck}$  shall be substituted for  $V_{sa}$ . For seismic loads,  $V_{sa,deck,eq}$  shall be substituted for  $V_{sa}$ .
- The minimum anchor spacing along the flute must be the greater of  $3.0h_{ef}$  or 1.5 times the flute width.
- The characteristic pull-out strength for greater concrete compressive strengths shall be increased by multiplying the tabular value by  $(f'_c / 3,000 \text{ psi})^{0.5}$ .
- Concrete shall be normal-weight or structural sand-lightweight concrete having a minimum specified compressive strength,  $f'_c$ , of 3,000 psi.
- Minimum distance to edge of panel is  $2h_{ef}$ .

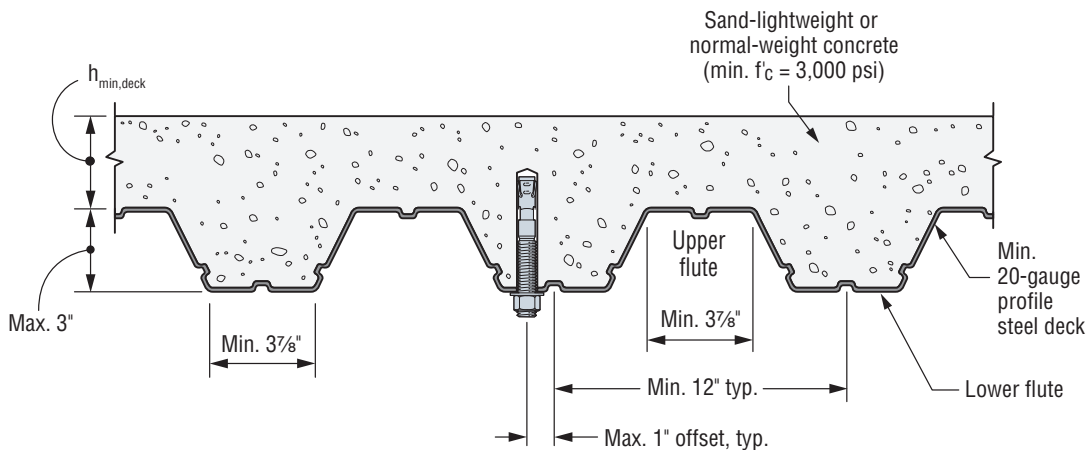

Figure 3

\* See p. 12 for an explanation of the load table icons.



# Strong-Bolt® 2 Design Information — Masonry

Carbon-Steel Strong-Bolt 2 Tension and Shear Loads in  
8" Lightweight, Medium-Weight and Normal-Weight Grout-Filled CMU

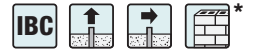

Size in. (mm)	Drill Bit Diameter (in.)	Min. Embed. Depth in. (mm)	Install. Torque ft.-lb. (N-m)	Critical Edge Dist. in. (mm)	Critical End Dist. in. (mm)	Critical Spacing in. (mm)	Tension Load		Shear Load	
							Ultimate lb. (kN)	Allowable lb. (kN)	Ultimate lb. (kN)	Allowable lb. (kN)
<b>Anchor Installed in the Face of the CMU Wall (See Figure 1)</b>										
1/4 (6.4)	1/4	1 3/4 (45)	4 (5.4)	12 (305)	12 (305)	8 (203)	1,150 (5.1)	230 (1.0)	1,500 (6.7)	300 (1.3)
3/8 (9.5)	3/8	2 5/8 (67)	20 (27.1)	12 (305)	12 (305)	8 (203)	2,185 (9.7)	435 (1.9)	3,875 (17.2)	775 (3.4)
1/2 (12.7)	1/2	3 1/2 (89)	35 (47.5)	12 (305)	12 (305)	8 (203)	2,645 (11.8)	530 (2.4)	5,055 (22.5)	1,010 (4.5)
5/8 (15.9)	5/8	4 3/8 (111)	55 (74.6)	20 (508)	20 (508)	8 (203)	4,460 (19.8)	890 (4.0)	8,815 (39.2)	1,765 (7.9)
3/4 (19.1)	3/4	5 1/4 (133)	100 (135.6)	20 (508)	20 (508)	8 (203)	5,240 (23.3)	1,050 (4.7)	12,450 (55.4)	2,490 (11.1)

- The tabulated allowable loads are based on a safety factor of 5.0 for installation under the IBC and IRC.
- Listed loads may be applied to installations on the face of the CMU wall at least 1 1/4" away from headjoints.
- Values for 8"-wide concrete masonry units (CMU) with a minimum specified compressive strength of masonry,  $f'_m$ , at 28 days is 1,500 psi.
- Embedment depth is measured from the outside face of the concrete masonry unit.
- Tension and shear loads may be combined using the parabolic interaction equation ( $n = 5\%$ ).
- Refer to allowable load adjustment factors for edge distance and spacing on p. 122.

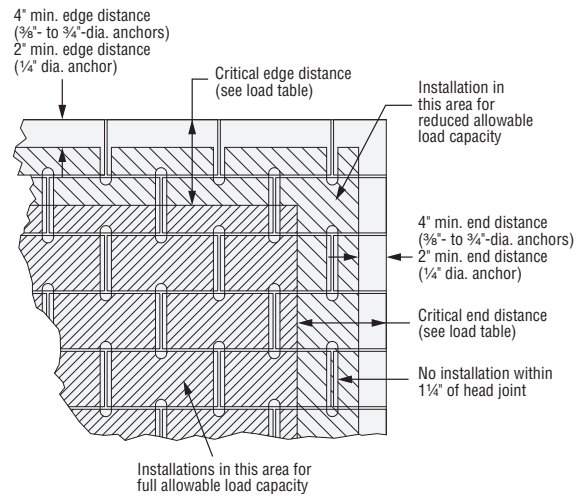

Figure 1

Carbon-Steel Strong-Bolt 2 Tension and Shear Loads in  
8" Lightweight, Medium-weight and Normal-Weight Grout-Filled CMU



Size in. (mm)	Drill Bit Diameter in.	Min. Embed. Depth in. (mm)	Install. Torque ft.-lb. (N-m)	Min. Edge Dist. in. (mm)	Critical End Dist. in. (mm)	Critical Spacing in. (mm)	Tension Load		Shear Load Perpendicular to Edge		Shear Load Parallel to Edge	
							Ultimate lb. (kN)	Allowable lb. (kN)	Ultimate lb. (kN)	Allowable lb. (kN)	Ultimate lb. (kN)	Allowable lb. (kN)
<b>Anchor Installed in Cell Opening or Web (Top of Wall) (See Figure 2)</b>												
1/2 (12.7)	1/2	3 1/2 (89)	35 (47.5)	1 3/4 (45)	12 (305)	8 (203)	2,080 (9.3)	415 (1.8)	1,165 (5.2)	235 (1.0)	3,360 (14.9)	670 (3.0)
5/8 (15.9)	5/8	4 3/8 (111)	55 (74.6)	1 3/4 (45)	12 (305)	8 (203)	3,200 (14.2)	640 (2.8)	1,370 (6.1)	275 (1.2)	3,845 (17.1)	770 (3.4)

- The tabulated allowable loads are based on a safety factor of 5.0 for installation under the IBC and IRC.
- Values for 8"-wide concrete masonry units (CMU) with a minimum specified compressive strength of masonry,  $f'_m$ , at 28 days is 1,500 psi.
- Tension and shear loads may be combined using the parabolic interaction equation ( $n = 5\%$ ).
- Refer to allowable load adjustment factors for edge distance and spacing on p. 122.

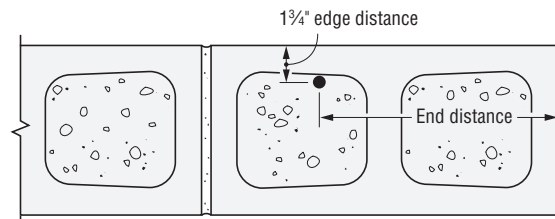

Figure 2

\* See p. 12 for an explanation of the load table icons.

# Strong-Bolt® 2 Design Information — Masonry

## Carbon-Steel Strong-Bolt 2 Allowable Load Adjustment Factors for Face-of-Wall Installation in 8" Grout-Filled CMU: Edge Distance and Spacing, Tension and Shear Loads

### How to use these charts:

1. The following tables are for reduced edge distance and spacing.
2. Locate the anchor size to be used for either a tension and/or shear load application.
3. Locate the embedment (E) at which the anchor is to be installed.
4. Locate the edge distance ( $c_{act}$ ) or spacing ( $s_{act}$ ) at which the anchor is to be installed.
5. The load adjustment factor ( $f_c$  or  $f_s$ ) is the intersection of the row and column.
6. Multiply the allowable load by the applicable load adjustment factor.
7. Reduction factors for multiple edges or spacings are multiplied together.

Mechanical Anchors

### Edge or End Distance Tension ( $f_c$ )

$c_{act}$ (in.)	Dia.	1/4	3/8	1/2	5/8	3/4
	E	1 1/4	2 5/8	3 1/2	4 3/8	5 1/4
	$c_{cr}$	12	12	12	20	20
	$c_{min}$	2	4	4	4	4
	$f_{cmin}$	1.00	1.00	1.00	1.00	0.97
2		1.00				
4		1.00	1.00	1.00	1.00	0.97
6		1.00	1.00	1.00	1.00	0.97
8		1.00	1.00	1.00	1.00	0.98
10		1.00	1.00	1.00	1.00	0.98
12		1.00	1.00	1.00	1.00	0.99
14					1.00	0.99
16					1.00	0.99
18					1.00	1.00
20					1.00	1.00

### Edge or End Distance Shear ( $f_c$ )

$c_{act}$ (in.)	Dia.	1/4	3/8	1/2	5/8	3/4
	E	1 1/4	2 5/8	3 1/2	4 3/8	5 1/4
	$c_{cr}$	12	12	12	20	20
	$c_{min}$	2	4	4	4	4
	$f_{cmin}$	0.88	0.71	0.60	0.36	0.28
2		0.88				
4		0.90	0.71	0.60	0.36	0.28
6		0.93	0.78	0.70	0.44	0.37
8		0.95	0.86	0.80	0.52	0.46
10		0.98	0.93	0.90	0.60	0.55
12		1.00	1.00	1.00	0.68	0.64
14					0.76	0.73
16					0.84	0.82
18					0.92	0.91
20					1.00	1.00

### Spacing Tension ( $f_s$ )

$s_{act}$ (in.)	Dia.	1/4	3/8	1/2	5/8	3/4
	E	1 1/4	2 5/8	3 1/2	4 3/8	5 1/4
	$s_{cr}$	8	8	8	8	8
	$s_{min}$	4	4	4	4	4
	$f_{smin}$	1.00	1.00	0.93	0.86	0.80
4		1.00	1.00	0.93	0.86	0.80
6		1.00	1.00	0.97	0.93	0.90
8		1.00	1.00	1.00	1.00	1.00

### Spacing Shear ( $f_s$ )

$s_{act}$ (in.)	Dia.	1/4	3/8	1/2	5/8	3/4
	E	1 1/4	2 5/8	3 1/2	4 3/8	5 1/4
	$s_{cr}$	8	8	8	8	8
	$s_{min}$	4	4	4	4	4
	$f_{smin}$	1.00	1.00	1.00	1.00	1.00
4		1.00	1.00	1.00	1.00	1.00
6		1.00	1.00	1.00	1.00	1.00
8		1.00	1.00	1.00	1.00	1.00

## Load Adjustment Factors for Carbon-Steel Strong-Bolt 2 Wedge Anchors in Top-of-Wall Installation in 8" Grout-Filled CMU: Edge Distance and Spacing, Tension and Shear Loads

### End Distance Tension ( $f_c$ )

$s_{act}$ (in.)	Dia.	1/2	5/8
	E	3 1/2	4 3/8
	$c_{cr}$	12	12
	$c_{min}$	4	4
	$f_{cmin}$	1.00	1.00
4		1.00	1.00
6		1.00	1.00
8		1.00	1.00
10		1.00	1.00
12		1.00	1.00

### End Distance Shear Perpendicular to Edge ( $f_c$ )

$c_{act}$ (in.)	Dia.	1/2	5/8
	E	3 1/2	4 3/8
	$c_{cr}$	12	12
	$c_{min}$	4	4
	$f_{cmin}$	0.90	0.83
4		0.90	0.83
6		0.93	0.87
8		0.95	0.92
10		0.98	0.96
12		1.00	1.00

### End Distance Shear Parallel to Edge ( $f_c$ )

$c_{act}$ (in.)	Dia.	1/2	5/8
	E	3 1/2	4 3/8
	$c_{cr}$	12	12
	$c_{min}$	4	4
	$f_{cmin}$	0.53	0.50
4		0.53	0.50
6		0.65	0.63
8		0.77	0.75
10		0.88	0.88
12		1.00	1.00

### Spacing Tension ( $f_s$ )

$s_{act}$ (in.)	Dia.	1/2	5/8
	E	3 1/2	4 3/8
	$s_{cr}$	8	8
	$s_{min}$	4	4
	$f_{smin}$	0.93	0.86
4		0.93	0.86
6		0.97	0.93
8		1.00	1.00

### Spacing Shear Perpendicular or Parallel to Edge ( $f_s$ )

$s_{act}$ (in.)	Dia.	1/2	5/8
	E	3 1/2	4 3/8
	$s_{cr}$	8	8
	$s_{min}$	4	4
	$f_{smin}$	1.00	1.00
4		1.00	1.00
6		1.00	1.00
8		1.00	1.00

For footnotes, please see p. 121.

\* See p. 12 for an explanation of the load table icons.

# Wedge-All® Wedge Anchor

The Wedge-All wedge-style expansion anchor is intended for use in solid concrete or grout-filled masonry. This anchor is best suited in installations where a building code approval for seismic and cracked/uncracked concrete is not required. Threaded studs are set by tightening the nut to the specified torque.

### Features



- One-piece, wrap-around clip ensures uniform holding capacity
- Threaded end is chamfered for ease of starting nut
- Available in a wide range of diameters and lengths

**Codes:** FM 3017082 and 3131136;  
UL File Ex3605;  
Multiple DOT listings;  
Meets the requirements of Federal Specification A-A-1923A, Type 4

**Material:** Carbon steel or stainless steel (Types 303/304; Type 316)

**Coating:** Carbon steel anchors are available zinc plated or mechanically galvanized

### Installation

-  Do not use an impact wrench to set or tighten anchors.
  -  **Caution:** Oversized holes in the base material will make it difficult to set the anchor and will reduce the anchor's load capacity.
1. Drill a hole in base material using a carbide drill bit the same diameter as the nominal diameter of the anchor to be installed. Drill the hole to the specified embedment depth, and blow it clean using compressed air. (Overhead installations need not be blown clean.) Alternatively, drill the hole deep enough to accommodate the embedment depth and the dust from drilling.
  2. Assemble the anchor with nut and washer so the top of the nut is flush with the top of the anchor. Place the anchor in the fixture, and drive it into the hole until the washer and nut are tight against the fixture.
  3. Tighten to the required installation torque.



**Head Stamp**  
The head is stamped with the length identification letter.

**Wedge-All Anchor**

### Installation Sequence

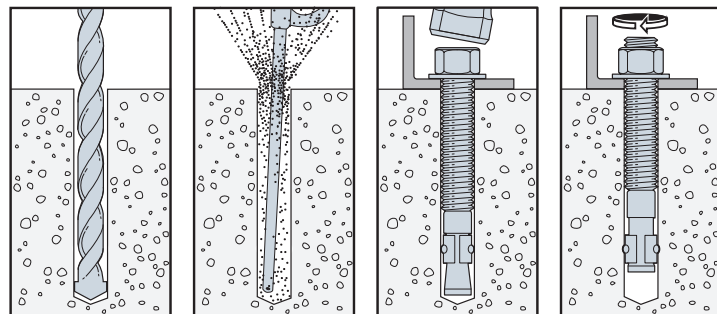

### Wedge-All Anchor Installation Data

Wedge-All Diameter (in.)	1/4	3/8	1/2	5/8	3/4	7/8	1	1 1/4
Drill Bit Size (in.)	1/4	3/8	1/2	5/8	3/4	7/8	1	1 1/4
Min. Fixture Hole (in.)	5/16	7/16	9/16	1 1/16	7/8	1	1 1/8	1 3/8
Wrench Size (in.)	7/16	9/16	3/4	15/16	1 1/8	1 5/16	1 1/2	1 7/8

Length Identification Head Marks on Wedge-All Anchors (corresponds to length of anchor — inches).

Mark	A	B	C	D	E	F	G	H	I	J	K	L	M	N	O	P	Q	R	S	T	U	V	W	X	Y	Z
From	1 1/2	2	2 1/2	3	3 1/2	4	4 1/2	5	5 1/2	6	6 1/2	7	7 1/2	8	8 1/2	9	9 1/2	10	11	12	13	14	15	16	17	18
Up To But Not Including	2	2 1/2	3	3 1/2	4	4 1/2	5	5 1/2	6	6 1/2	7	7 1/2	8	8 1/2	9	9 1/2	10	11	12	13	14	15	16	17	18	19

# Wedge-All® Wedge Anchor

Mechanical Anchors

Wedge-All Anchor Product Data — Carbon Steel:  
Zinc Plated and Mechanically Galvanized

Size (in.)	Zinc Plated Model No.	Mechanically Galvanized Model No.	Drill Bit Dia. (in.)	Thread Length (in.)	Quantity		
					Box	Carton	
¼ x 2¼	—	WA25214MG	¼	1⅞	100	500	
¼ x 3¼	—	WA25314MG		2⅞	100	500	
⅜ x 2¼	WA37214	WA37214MG	⅜	1⅞	50	250	
⅜ x 2¾	WA37234	WA37234MG		1⅞	50	250	
⅜ x 3	WA37300	WA37300MG		1⅞	50	250	
⅜ x 3½	WA37312	WA37312MG		2½	50	250	
⅜ x 3¾	WA37334	WA37334MG		2⅞	50	250	
⅜ x 5	WA37500	WA37500MG		3⅞	50	200	
⅜ x 7	WA37700	WA37700MG		5⅞	50	200	
½ x 2¾	WA50234	WA50234MG		½	1⅞	25	125
½ x 3¾	WA50334	WA50334MG	2⅞		25	125	
½ x 4¼	WA50414	WA50414MG	2⅞		25	100	
½ x 5½	WA50512	WA50512MG	4⅞		25	100	
½ x 7	WA50700	WA50700MG	4⅞		25	100	
½ x 8½	WA50812	WA50812MG	6		25	50	
½ x 10	WA50100	WA50100MG	6		25	50	
½ x 12	WA50120	WA50120MG	6		25	50	
⅝ x 3½	WA62312	WA62312MG	⅝		1⅞	20	80
⅝ x 4½	WA62412	WA62412MG			2⅞	20	80
⅝ x 5	WA62500	WA62500MG		3⅞	20	80	
⅝ x 6	WA62600	WA62600MG		4⅞	20	80	
⅝ x 7	WA62700	WA62700MG		5⅞	20	80	
⅝ x 8½	WA62812	WA62812MG		6	20	40	
⅝ x 10	WA62100	WA62100MG		6	10	20	
⅝ x 12	WA62120	WA62120MG		6	10	20	
¾ x 4¼	WA75414	WA75414MG	¾	2⅞	10	40	
¾ x 4¾	WA75434	WA75434MG		2⅞	10	40	
¾ x 5½	WA75512	WA75512MG		3⅞	10	40	
¾ x 6¼	WA75614	WA75614MG		4⅞	10	40	
¾ x 7	WA75700	WA75700MG		5⅞	10	40	
¾ x 8½	WA75812	WA75812MG		6	10	20	
¾ x 10	WA75100	WA75100MG		6	10	20	
¾ x 12	WA75120	WA75120MG		6	5	10	
⅞ x 6	WA87600	WA87600MG	⅞	2⅞	5	20	
⅞ x 8	WA87800	WA87800MG		2⅞	5	10	
⅞ x 10	WA87100	WA87100MG		2⅞	5	10	
⅞ x 12	WA87120	WA87120MG		2⅞	5	10	
1 x 6	WA16000	WA16000MG	1	2¼	5	20	
1 x 9	WA19000	WA19000MG		2¼	5	10	
1 x 12	WA11200	WA11200MG		2¼	5	10	
1¼ x 9	WA12590	—	1¼	2¾	5	10	
1¼ x 12	WA12512	—		2¾	5	10	

1. The published length is the overall length of the anchor. Allow one anchor diameter for the nut and washer thickness plus the fixture thickness when selecting the minimum length.

## Material Specifications

Carbon Steel — Zinc Plated			
Component Materials			
Anchor Body	Nut	Washer	Clip
Material meets minimum 70,000 psi tensile strength	Carbon Steel ASTM A 563, Grade A	Carbon Steel	Carbon Steel

## Material Specifications

Carbon Steel — Mechanically Galvanized			
Component Materials			
Anchor Body	Nut	Washer	Clip
Material meets minimum 70,000 psi tensile strength	Carbon Steel ASTM A 563, Grade A	Carbon Steel	Carbon Steel

## Wedge-All® Wedge Anchor

## Wedge-All Anchor Product Data — Stainless Steel

Size (in.)	Type 303/304 Stainless Model No. <sup>2</sup>	Type 316 Stainless Model No.	Drill Bit Dia. (in.)	Thread Length (in.)	Quantity	
					Box	Carton
3/8 x 2 1/4	WA372144SS	WA372146SS	3/8	1 1/8	50	250
3/8 x 2 3/4	WA372344SS	WA372346SS		1 5/8	50	250
3/8 x 3	WA373004SS	WA373006SS		1 7/8	50	250
3/8 x 3 1/2	WA373124SS	WA373126SS		2 1/2	50	250
3/8 x 3 3/4	WA373344SS	WA373346SS		2 5/8	50	250
3/8 x 5	WA375004SS	WA375006SS		3 7/8	50	200
3/8 x 7	WA377004SS	WA377006SS		5 7/8	50	200
1/2 x 2 3/4	WA502344SS	WA502346SS	1/2	1 5/16	25	125
1/2 x 3 3/4	WA503344SS	WA503346SS		2 5/16	25	125
1/2 x 4 1/4	WA504144SS	WA504146SS		2 13/16	25	100
1/2 x 5 1/2	WA505124SS	WA505126SS		4 1/16	25	100
1/2 x 7	WA507004SS	WA507006SS		5 9/16	25	100
1/2 x 8 1/2	WA508124SS	WA508126SS		2	25	50
1/2 x 10	WA50100SS	—		2	25	50
1/2 x 12	WA50120SS	—	2	25	50	
5/8 x 3 1/2	WA623124SS	WA623126SS	5/8	1 7/8	20	80
5/8 x 4 1/2	WA624124SS	WA624126SS		2 7/8	20	80
5/8 x 5	WA625004SS	WA625006SS		3 3/8	20	80
5/8 x 6	WA626004SS	WA626006SS		4 3/8	20	80
5/8 x 7	WA627004SS	WA627006SS		5 3/8	20	80
5/8 x 8 1/2	WA628124SS	WA628126SS		2	20	40
5/8 x 10	WA62100SS	WA621003SS		2	10	20
5/8 x 12	WA62120SS	WA621203SS	2	10	20	
3/4 x 4 1/4	WA754144SS	WA754146SS	3/4	2 3/8	10	40
3/4 x 4 3/4	WA754344SS	WA754346SS		2 7/8	10	40
3/4 x 5 1/2	WA755124SS	WA755126SS		3 5/8	10	40
3/4 x 6 1/4	WA756144SS	WA756146SS		4 3/8	10	40
3/4 x 7	WA757004SS	WA757006SS		5 1/8	10	40
3/4 x 8 1/2	WA758124SS	WA758126SS		2 1/4	10	20
3/4 x 10	WA75100SS	WA751003SS		2 1/4	10	20
3/4 x 12	WA75120SS	—	2 1/4	5	10	
7/8 x 6	WA87600SS	—	7/8	2 1/8	5	20
7/8 x 8	WA87800SS	WA878003SS		2 1/8	5	10
7/8 x 10	WA87100SS	—		2 1/8	5	10
7/8 x 12	WA87120SS	—		2 1/8	5	10
1 x 6	WA16000SS	—	1	2 1/4	5	20
1 x 9	WA19000SS	WA190003SS		2 1/4	5	10
1 x 12	WA11200SS	WA112003SS		2 1/4	5	10

- The published length is the overall length of the anchor. Allow one anchor diameter for the nut and washer thickness plus the fixture thickness when selecting a length.
- Anchors with the "SS" suffix in the model number are manufactured from Type 303 stainless steel; the remaining anchors (with the "4SS" suffix) are manufactured from Type 304 stainless steel. Types 303 and 304 stainless steel perform equally well in certain corrosive environments.

## Material Specifications

Type 303/304 Stainless Steel <sup>1</sup>			
Component Materials			
Anchor Body	Nut	Washer	Clip
Type 303 or 304 stainless steel	Type 304 stainless steel	Type 304 stainless steel	Type 304 or 316 stainless steel

- Types 303 and 304 stainless steels perform equally well in certain corrosive environments. Larger sizes are manufactured from Type 303.

## Material Specifications

Type 316 Stainless Steel <sup>1</sup>			
Component Materials			
Anchor Body	Nut	Washer	Clip
Type 316 stainless steel	Type 316 stainless steel	Type 316 stainless steel	Type 316 stainless steel

- Type 316 stainless steel provides the greatest degree of corrosion resistance offered by Simpson Strong-Tie.

# Wedge-All® Design Information — Concrete



Carbon-Steel Wedge-All Allowable Tension Loads in Normal-Weight Concrete

Mechanical Anchors

Size in. (mm)	Embed. Depth in. (mm)	Critical Edge Dist. in. (mm)	Critical Spacing in. (mm)	Tension Load							Install. Torque ft.-lb. (N-m)
				f' <sub>c</sub> ≥ 2,000 psi (13.8 MPa) Concrete			f' <sub>c</sub> ≥ 3,000 psi (20.7 MPa) Concrete		f' <sub>c</sub> ≥ 4,000 psi (27.6 MPa) Concrete		
				Ultimate lb. (kN)	Std. Dev. lb. (kN)	Allowable lb. (kN)	Allowable lb. (kN)	Ultimate lb. (kN)	Std. Dev. lb. (kN)	Allowable lb. (kN)	
¼ (6.4)	1½ (29)	2½ (64)	1½ (41)	680 (3.0)	167 (0.7)	170 (0.8)	205 (0.9)	960 (4.3)	233 (1.0)	240 (1.1)	8 (10.8)
	2¼ (57)	2½ (64)	3½ (79)	1,920 (8.5)	286 (1.3)	480 (2.1)	530 (2.4)	2,320 (10.3)	105 (0.5)	580 (2.6)	
⅜ (9.5)	1¾ (44)	3¾ (95)	2⅝ (60)	1,560 (6.9)	261 (1.2)	390 (1.7)	555 (2.5)	2,880 (12.8)	588 (2.6)	720 (3.2)	30 (40.7)
	2⅝ (67)	3¾ (95)	3⅝ (92)	3,360 (14.9)	464 (2.1)	840 (3.7)	1,100 (4.9)	5,440 (24.2)	553 (2.5)	1,360 (6.0)	
	3⅝ (86)	3¾ (95)	4¾ (121)	3,680 (16.4)	585 (2.6)	920 (4.1)	1,140 (5.1)	5,440 (24.2)	318 (1.4)	1,360 (6.0)	
½ (12.7)	2¼ (57)	5 (127)	3⅝ (79)	3,280 (14.6)	871 (3.9)	820 (3.6)	1,070 (4.8)	5,280 (23.5)	849 (3.8)	1,320 (5.9)	60 (81.3)
	3⅝ (86)	5 (127)	4¾ (121)	6,040 (26.9)	654 (2.9)	1,510 (6.7)	1,985 (8.8)	9,840 (43.8)	1,303 (5.8)	2,460 (10.9)	
	4½ (114)	5 (127)	6¼ (159)	6,960 (31.0)	839 (3.7)	1,740 (7.7)	2,350 (10.5)	11,840 (52.7)	2,462 (11.0)	2,960 (13.2)	
⅝ (15.9)	2¾ (70)	6¼ (159)	3⅝ (98)	4,520 (20.1)	120 (0.5)	1,130 (5.0)	1,640 (7.3)	8,600 (38.3)	729 (3.2)	2,150 (9.6)	90 (122.0)
	4½ (114)	6¼ (159)	6¼ (159)	8,200 (36.5)	612 (2.7)	2,050 (9.1)	2,990 (13.3)	15,720 (69.9)	1,224 (5.4)	3,930 (17.5)	
	5½ (140)	6¼ (159)	7¾ (197)	8,200 (36.5)	639 (2.8)	2,050 (9.1)	2,990 (13.3)	15,720 (69.9)	1,116 (5.0)	3,930 (17.5)	
¾ (19.1)	3⅝ (86)	7½ (191)	4¾ (121)	6,760 (30.1)	1,452 (6.5)	1,690 (7.5)	2,090 (9.3)	9,960 (44.3)	1,324 (5.9)	2,490 (11.1)	150 (203.4)
	5 (127)	7½ (191)	7 (178)	10,040 (44.7)	544 (2.4)	2,510 (11.2)	3,225 (14.3)	15,760 (70.1)	1,550 (6.9)	3,940 (17.5)	
	6¾ (171)	7½ (191)	9½ (241)	10,040 (44.7)	1,588 (7.1)	2,510 (11.2)	3,380 (15.0)	17,000 (75.6)	1,668 (7.4)	4,250 (18.9)	
⅞ (22.2)	3⅝ (98)	8¾ (222)	5⅝ (137)	7,480 (33.3)	821 (3.7)	1,870 (8.3)	2,275 (10.1)	10,720 (47.7)	1,253 (5.6)	2,680 (11.9)	200 (271.2)
	7⅝ (200)	8¾ (222)	11 (279)	17,040 (75.8)	1,566 (7.0)	4,260 (18.9)	4,670 (20.8)	20,320 (90.4)	2,401 (10.7)	5,080 (22.6)	
1 (25.4)	4½ (114)	10 (254)	6¼ (159)	11,550 (51.4)	1,830 (8.1)	2,888 (12.8)	2,891 (12.9)	11,760 (52.3)	1,407 (6.3)	2,940 (13.1)	225 (305.1)
	9 (229)	10 (254)	12⅝ (321)	15,570 (69.3)	2,337 (10.4)	3,893 (17.3)	4,766 (21.2)	22,560 (100.4)	1,209 (5.4)	5,640 (25.1)	
1¼ (31.8)	5⅝ (143)	12½ (318)	7⅝ (200)	11,370 (50.6)	1,010 (4.5)	2,843 (12.6)	3,743 (16.6)	18,570 (82.6)	469 (2.1)	4,643 (20.7)	400 (542.3)
	9½ (241)	12½ (318)	13¼ (337)	15,120 (67.3)	2,438 (10.8)	3,780 (16.8)	6,476 (28.8)	36,690 (163.2)	1,270 (5.6)	9,173 (40.8)	

1. The allowable loads listed are based on a safety factor of 4.0.
2. Refer to allowable load-adjustment factors for edge distance and spacing on pp. 131 and 133.
3. Drill bit diameter used in base material corresponds to nominal anchor diameter.
4. Allowable loads may be linearly interpolated between concrete strengths listed.
5. The minimum concrete thickness is 1½ times the embedment depth.

\* See p. 12 for an explanation of the load table icons.

## Wedge-All® Design Information — Concrete

## Carbon-Steel Wedge-All Allowable Shear Loads in Normal-Weight Concrete



Size in. (mm)	Embed. Depth in. (mm)	Critical Edge Dist. in. (mm)	Critical Spacing in. (mm)	Shear Load					Install. Torque ft.-lb. (N-m)
				$f'_c \geq 2,000$ psi (13.8 MPa) Concrete			$f'_c \geq 3,000$ psi (20.7 MPa) Concrete	$f'_c \geq 4,000$ psi (27.6 MPa) Concrete	
				Ultimate lb. (kN)	Std. Dev. lb. (kN)	Allowable lb. (kN)	Allowable lb. (kN)	Allowable lb. (kN)	
¼ (6.4)	1½ (29)	2½ (64)	1½ (41)	920 (4.1)	47 (0.2)	230 (1.0)	230 (1.0)	230 (1.0)	8 (10.8)
	2¼ (57)	2½ (64)	3½ (79)	—	—	230 (1.0)	230 (1.0)	230 (1.0)	
⅜ (9.5)	1¾ (44)	3¼ (95)	2¾ (60)	2,280 (10.1)	96 (0.4)	570 (2.5)	570 (2.5)	570 (2.5)	30 (40.7)
	2⅝ (67)	3¼ (95)	3⅝ (92)	4,220 (18.8)	384 (1.7)	1,055 (4.7)	1,055 (4.7)	1,055 (4.7)	
	3⅝ (86)	3¼ (95)	4¼ (121)	—	—	1,055 (4.7)	1,055 (4.7)	1,055 (4.7)	
½ (12.7)	2¼ (57)	5 (127)	3½ (79)	6,560 (29.2)	850 (3.8)	1,345 (6.0)	1,485 (6.6)	1,625 (7.2)	60 (81.3)
	3⅝ (86)	5 (127)	4¼ (121)	8,160 (36.3)	880 (3.9)	1,675 (7.5)	1,850 (8.2)	2,020 (9.0)	
	4½ (114)	5 (127)	6¼ (159)	—	—	1,675 (7.5)	1,850 (8.2)	2,020 (9.0)	
⅝ (15.9)	2¾ (70)	6¼ (159)	3¾ (98)	8,720 (38.8)	1,699 (7.6)	1,620 (7.2)	1,900 (8.5)	2,180 (9.7)	90 (122.0)
	4½ (114)	6¼ (159)	6¼ (159)	12,570 (55.9)	396 (1.8)	2,330 (10.4)	2,740 (12.2)	3,145 (14.0)	
	5½ (140)	6¼ (159)	7¾ (197)	—	—	2,330 (10.4)	2,740 (12.2)	3,145 (14.0)	
¾ (19.1)	3⅝ (86)	7½ (191)	4¼ (121)	11,360 (50.5)	792 (3.5)	2,840 (12.6)	2,840 (12.6)	2,840 (12.6)	150 (203.4)
	5 (127)	7½ (191)	7 (178)	18,430 (82.0)	1,921 (8.5)	4,610 (20.5)	4,610 (20.5)	4,610 (20.5)	
	6¼ (171)	7½ (191)	9½ (241)	—	—	4,610 (20.5)	4,610 (20.5)	4,610 (20.5)	
⅞ (22.2)	3¾ (98)	8¼ (222)	5⅝ (137)	13,760 (61.2)	2,059 (9.2)	3,440 (15.3)	3,440 (15.3)	3,440 (15.3)	200 (271.2)
	7¾ (200)	8¼ (222)	11 (279)	22,300 (99.2)	477 (2.1)	5,575 (24.8)	5,575 (24.8)	5,575 (24.8)	
1 (25.4)	4½ (114)	10 (254)	6¼ (159)	22,519 (100.2)	1,156 (5.1)	5,730 (25.5)	5,730 (25.5)	5,730 (25.5)	300 (406.7)
	9 (229)	10 (254)	12⅝ (321)	25,380 (112.9)	729 (3.2)	6,345 (28.2)	6,345 (28.2)	6,345 (28.2)	
1¼ (31.8)	5⅝ (143)	12½ (318)	7¾ (200)	29,320 (130.4)	2,099 (9.3)	7,330 (32.6)	7,330 (32.6)	7,330 (32.6)	400 (542.3)
	9½ (241)	12½ (318)	13¼ (337)	—	—	7,330 (32.6)	7,330 (32.6)	7,330 (32.6)	

1. The allowable loads listed are based on a safety factor of 4.0.
2. Refer to allowable load-adjustment factors for spacing and edge distance on pp. 132, 134 and 135.
3. Drill bit diameter used in base material corresponds to nominal anchor diameter.
4. Allowable loads may be linearly interpolated between concrete strengths listed.
5. The minimum concrete thickness is 1½ times the embedment depth.

\* See p. 12 for an explanation of the load table icons.

## Wedge-All® Design Information — Concrete

Stainless-Steel Wedge-All Allowable Tension Loads in Normal-Weight Concrete



Size in. (mm)	Embed. Depth in. (mm)	Critical Edge Dist. in. (mm)	Critical Spacing in. (mm)	Allowable Tension Load lb. (kN)			Install. Torque ft.-lb. (N-m)
				$f'_c \geq 2,000$ psi (13.8 MPa) Concrete	$f'_c \geq 3,000$ psi (20.7 MPa) Concrete	$f'_c \geq 4,000$ psi (27.6 MPa) Concrete	
¼ (6.4)	1½ (29)	2½ (64)	1⅝ (41)	155 (0.7)	185 (0.8)	215 (1.0)	8 (10.8)
	2¼ (57)	2½ (64)	3⅝ (79)	430 (1.9)	475 (2.1)	520 (2.3)	
⅜ (9.5)	1¾ (44)	3¾ (95)	2⅝ (60)	350 (1.6)	500 (2.2)	650 (2.9)	30 (40.7)
	2⅝ (67)	3¾ (95)	3⅝ (92)	755 (3.4)	990 (4.4)	1,225 (5.4)	
	3⅝ (86)	3¾ (95)	4¾ (121)	830 (3.7)	1,025 (4.6)	1,225 (5.4)	
½ (12.7)	2¼ (57)	5 (127)	3⅝ (79)	740 (3.3)	965 (4.3)	1,190 (5.3)	60 (81.3)
	3⅝ (86)	5 (127)	4¾ (121)	1,360 (6.0)	1,785 (7.9)	2,215 (9.9)	
	4½ (114)	5 (127)	6¼ (159)	1,565 (7.0)	2,115 (9.4)	2,665 (11.9)	
⅝ (15.9)	2¾ (70)	6¼ (159)	3⅝ (98)	1,015 (4.5)	1,475 (6.6)	1,935 (8.6)	90 (122.0)
	4½ (114)	6¼ (159)	6¼ (159)	1,845 (8.2)	2,690 (12.0)	3,535 (15.7)	
	5½ (140)	6¼ (159)	7¾ (197)	1,845 (8.2)	2,690 (12.0)	3,535 (15.7)	
¾ (19.1)	3⅝ (86)	7½ (191)	4¾ (121)	1,520 (6.8)	1,880 (8.4)	2,240 (10.0)	150 (203.4)
	5 (127)	7½ (191)	7 (178)	2,260 (10.1)	2,905 (12.9)	3,545 (15.8)	
	6¾ (171)	7½ (191)	9½ (241)	2,260 (10.1)	3,040 (13.5)	3,825 (17.0)	
⅞ (22.2)	3⅝ (98)	8¾ (222)	5⅝ (137)	1,685 (7.5)	2,050 (9.1)	2,410 (10.7)	200 (271.2)
	7⅝ (200)	8¾ (222)	11 (279)	3,835 (17.1)	4,205 (18.7)	4,570 (20.3)	
1 (25.4)	4½ (114)	10 (254)	6¼ (159)	2,599 (11.6)	2,621 (11.7)	2,648 (11.8)	225 (305.1)
	9 (229)	10 (254)	12⅝ (321)	3,503 (15.6)	4,290 (19.1)	5,078 (22.6)	
1¼ (31.8)	5⅝ (143)	12½ (318)	7⅝ (200)	2,558 (11.4)	3,368 (15.0)	4,178 (18.6)	400 (542.3)
	9½ (241)	12½ (318)	13¼ (337)	3,401 (15.1)	5,828 (25.9)	8,254 (36.7)	

1. The allowable loads listed are based on a safety factor of 4.0.
2. Refer to allowable load-adjustment factors for edge distance and spacing on pp. 131 and 133.
3. Drill bit diameter used in base material corresponds to nominal anchor diameter.
4. Allowable loads may be linearly interpolated between concrete strengths listed.
5. The minimum concrete thickness is 1½ times the embedment depth.

\* See p. 12 for an explanation of the load table icons.



# Wedge-All® Design Information — Concrete

## Stainless-Steel Wedge-All Allowable Shear Loads in Normal-Weight Concrete



Size in. (mm)	Embed. Depth in. (mm)	Critical Edge Dist. in. (mm)	Critical Spacing in. (mm)	Allowable Shear Load lb. (kN)			Install. Torque ft.-lb. (N-m)
				$f'_c \geq 2,000$ psi (13.8 MPa) Concrete	$f'_c \geq 3,000$ psi (20.7 MPa) Concrete	$f'_c \geq 4,000$ psi (27.6 MPa) Concrete	
1/4 (6.4)	1 1/8 (29)	2 1/2 (64)	1 5/8 (41)	265 (1.2)	265 (1.2)	265 (1.2)	8 (10.8)
	2 1/4 (57)	2 1/2 (64)	3 1/8 (79)	265 (1.2)	265 (1.2)	265 (1.2)	
3/8 (9.5)	1 3/4 (44)	3 3/4 (95)	2 3/8 (60)	655 (2.9)	655 (2.9)	655 (2.9)	30 (40.7)
	2 5/8 (67)	3 3/4 (95)	3 5/8 (92)	1,215 (5.4)	1,215 (5.4)	1,215 (5.4)	
	3 3/8 (86)	3 3/4 (95)	4 3/4 (121)	1,215 (5.4)	1,215 (5.4)	1,215 (5.4)	
1/2 (12.7)	2 1/4 (57)	5 (127)	3 1/8 (79)	1,545 (6.9)	1,710 (7.6)	1,870 (8.3)	60 (81.3)
	3 3/8 (86)	5 (127)	4 3/4 (121)	1,925 (8.6)	2,130 (9.5)	2,325 (10.3)	
	4 1/2 (114)	5 (127)	6 1/4 (159)	1,925 (8.6)	2,130 (9.5)	2,325 (10.3)	
5/8 (15.9)	2 3/4 (70)	6 1/4 (159)	3 7/8 (98)	1,865 (8.3)	2,185 (9.7)	2,505 (11.1)	90 (122.0)
	4 1/2 (114)	6 1/4 (159)	6 1/4 (159)	2,680 (11.9)	3,150 (14.0)	3,615 (16.1)	
	5 1/2 (140)	6 1/4 (159)	7 3/4 (197)	2,680 (11.9)	3,150 (14.0)	3,615 (16.1)	
3/4 (19.1)	3 3/8 (86)	7 1/2 (191)	4 3/4 (121)	3,265 (14.5)	3,265 (14.5)	3,265 (14.5)	150 (203.4)
	5 (127)	7 1/2 (191)	7 (178)	5,300 (23.6)	5,300 (23.6)	5,300 (23.6)	
	6 3/4 (171)	7 1/2 (191)	9 1/2 (241)	5,300 (23.6)	5,300 (23.6)	5,300 (23.6)	
7/8 (22.2)	3 7/8 (98)	8 3/4 (222)	5 3/8 (137)	3,955 (17.6)	3,955 (17.6)	3,955 (17.6)	200 (271.2)
	7 7/8 (200)	8 3/4 (222)	11 (279)	6,410 (28.5)	6,410 (28.5)	6,410 (28.5)	
1 (25.4)	4 1/2 (114)	10 (254)	6 1/4 (159)	6,590 (29.3)	6,590 (29.3)	6,590 (29.3)	300 (406.7)
	9 (229)	10 (254)	12 5/8 (321)	7,295 (32.4)	7,295 (32.4)	7,295 (32.4)	
1 1/4 (31.8)	5 5/8 (143)	12 1/2 (318)	7 7/8 (200)	8,430 (37.5)	8,430 (37.5)	8,430 (37.5)	400 (542.3)
	9 1/2 (241)	12 1/2 (318)	13 1/4 (337)	8,430 (37.5)	8,430 (37.5)	8,430 (37.5)	

1. The allowable loads listed are based on a safety factor of 4.0.
2. Refer to allowable load-adjustment factors for spacing and edge distance on pp. 131–132 and 134.
3. Drill bit diameter used in base material corresponds to nominal anchor diameter.
4. Allowable loads may be linearly interpolated between concrete strengths listed.
5. The minimum concrete thickness is 1 1/2 times the embedment depth.

\* See p. 12 for an explanation of the load table icons.

# Wedge-All® Design Information — Concrete and Masonry

## Carbon-Steel Wedge-All Allowable Tension Loads in Sand-Lightweight Concrete over Steel Deck



Size in. (mm)	Embed. Depth in. (mm)	Critical Edge Dist. in. (mm)	Critical Spacing in. (mm)	Tension Load (Install in Concrete)			Tension Load (Install Through Steel Deck)			Install. Torque ft.-lb. (N-m)
				$f'_c \geq 3,000$ psi (20.7 MPa) Concrete			$f'_c \geq 3,000$ psi (20.7 MPa) Concrete			
				Ultimate lb. (kN)	Std. Dev. lb. (kN)	Allow. lb. (kN)	Ultimate lb. (kN)	Std. Dev. lb. (kN)	Allow. lb. (kN)	
1/4 (6.4)	1 1/2 (38)	3 3/8 (86)	2 3/4 (70)	—	—	—	1,440 (6.4)	167 (0.7)	360 (1.6)	—
1/2 (12.7)	2 1/4 (57)	6 3/4 (171)	4 1/8 (105)	3,880 (17.3)	228 (1.0)	970 (4.3)	3,860 (17.2)	564 (2.5)	965 (4.3)	60 (81.3)
5/8 (15.9)	2 3/4 (70)	8 3/8 (213)	5 (127)	5,920 (26.3)	239 (1.1)	1,480 (6.6)	5,220 (23.2)	370 (1.6)	1,305 (5.8)	90 (122.0)
3/4 (19.1)	3 3/8 (>86)	10 (254)	6 1/8 (156)	7,140 (31.8)	537 (2.4)	1,785 (7.9)	6,600 (29.4)	903 (4.0)	1,650 (7.3)	150 (203.4)

See footnotes 1–7 below.

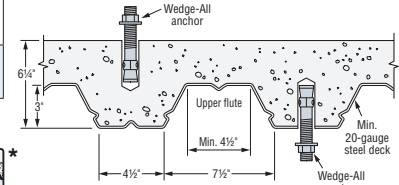

**Lightweight Concrete on Steel Deck**

## Carbon-Steel Wedge-All Allowable Shear Loads in Sand-Lightweight Concrete over Steel Deck



Size in. (mm)	Embed. Depth in. (mm)	Critical Edge Dist. in. (mm)	Critical Spacing in. (mm)	Shear Load (Install in Concrete)			Shear Load (Install Through Steel Deck)			Install. Torque ft.-lb. (N-m)
				$f'_c \geq 3,000$ psi (20.7 MPa) Concrete			$f'_c \geq 3,000$ psi (20.7 MPa) Concrete			
				Ultimate lb. (kN)	Std. Dev. lb. (kN)	Allow. lb. (kN)	Ultimate lb. (kN)	Std. Dev. lb. (kN)	Allow. lb. (kN)	
1/4 (6.4)	1 1/2 (38)	3 3/8 (86)	2 3/4 (70)	—	—	—	1,660 (7.4)	627 (2.8)	415 (1.8)	—
1/2 (12.7)	2 1/4 (57)	6 3/4 (171)	4 1/8 (105)	5,575 (24.8)	377 (1.7)	1,395 (6.2)	7,260 (32.3)	607 (2.7)	1,815 (8.1)	60 (81.3)
5/8 (15.9)	2 3/4 (70)	8 3/8 (213)	5 (127)	8,900 (39.6)	742 (3.3)	2,225 (9.9)	8,560 (38.1)	114 (0.5)	2,140 (9.5)	90 (122.0)
3/4 (19.1)	3 3/8 (86)	10 (254)	6 1/8 (156)	10,400 (46.3)	495 (2.2)	2,600 (11.6)	11,040 (49.1)	321 (1.4)	2,760 (12.3)	150 (203.4)

- The allowable loads listed are based on a safety factor of 4.0.
- Refer to allowable load-adjustment factors for edge distance on p. 135.
- 100% of the allowable load is permitted at critical spacing. Loads at reduced spacing have not been determined.
- Drill bit diameter used in base material corresponds to nominal anchor diameter.
- The minimum concrete thickness is 1 1/2 times the embedment depth.
- Steel deck must be minimum 20 gauge.
- Anchors installed in the bottom flute of the steel deck must have a minimum allowable edge distance of 1 1/2" from the inclined edge of the bottom flute.

## Carbon-Steel Wedge-All Allowable Tension and Shear Loads in Grout-Filled CMU



Size in. (mm)	Embed. Depth in. (mm)	Critical Edge Dist. in. (mm)	Critical End Dist. in. (mm)	Critical Spacing in. (mm)	8" Grout-Filled CMU Allowable Load Based on CMU Strength						Install. Torque ft.-lb. (N-m)
					Tension Load			Shear Load			
					Ultimate lb. (kN)	Std. Dev. lb. (kN)	Allow. lb. (kN)	Ultimate lb. (kN)	Std. Dev. lb. (kN)	Allow. lb. (kN)	
<b>Anchor Installed on the Face of the CMU Wall at Least 1 1/4 inch Away from Head Joint (See Figure)</b>											
3/8 (9.5)	2 5/8 (67)	10 1/2 (267)	10 1/2 (267)	10 1/2 (267)	1,700 (7.6)	129 (0.6)	340 (1.5)	3,360 (14.9)	223 (1.0)	670 (3.0)	30 (40.7)
1/2 (12.7)	3 1/2 (89)	14 (356)	14 (356)	14 (356)	2,120 (9.4)	129 (0.6)	425 (1.9)	5,360 (23.8)	617 (2.7)	1,070 (4.8)	35 (47.4)
5/8 (15.9)	4 3/8 (111)	17 1/2 (445)	17 1/2 (445)	17 1/2 (445)	3,120 (13.9)	342 (1.5)	625 (2.8)	8,180 (36.4)	513 (2.3)	1,635 (7.3)	55 (74.5)
3/4 (19.1)	5 1/4 (133)	21 (533)	21 (533)	21 (533)	4,320 (19.2)	248 (1.1)	865 (3.8)	10,160 (45.2)	801 (3.6)	2,030 (9.0)	120 (162.6)

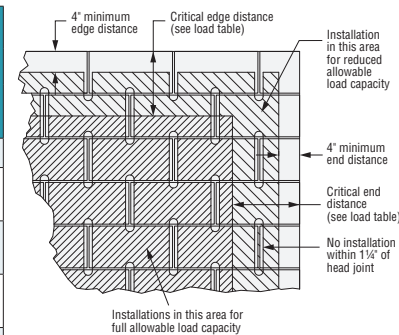

**Shaded area = Placement for Full and Reduced Allowable Load Capacity in Grout-Filled CMU**

- The tabulated allowable loads are based on a safety factor of 5.0 for installations under the IBC and IRC.
- Listed loads may be applied to installations on the face of the CMU wall at least 1 1/4" away from headjoints.
- Values for 8"-wide concrete masonry units (CMU) with a minimum specified compressive strength of masonry,  $f'_m$ , at 28 days is 1,500 psi.
- Embedment depth is measured from the outside face of the concrete masonry unit.
- Drill bit diameter used in base material corresponds to nominal anchor diameter.
- Tension and shear loads for the Wedge-All anchor may be combined using the parabolic interaction equation ( $n = 5/3$ ).
- Refer to allowable load-adjustment factors for edge distance on p. 135.

\* See p. 12 for an explanation of the load table icons.

# Wedge-All® Design Information — Concrete

## Allowable Load-Adjustment Factors for Carbon-Steel and Stainless-Steel Wedge-All Anchors in Normal-Weight Concrete: Edge Distance, Tension and Shear Loads

### How to use these charts:

1. The following tables are for reduced edge distance.
2. Locate the anchor size to be used for either a tension and/or shear load application.
3. Locate the edge distance ( $c_{act}$ ) at which the anchor is to be installed.
4. The load adjustment factor ( $f_c$ ) is the intersection of the row and column.
5. Multiply the allowable load by the applicable load adjustment factor.
6. Reduction factors for multiple edges are multiplied together.

### Edge Distance Tension ( $f_c$ )

Edge Dist. $c_{act}$ (in.)	Size	1/4	3/8	1/2	5/8	3/4	7/8	1	1 1/4
	$c_{cr}$	2 1/2	3 3/4	5	6 1/4	7 1/2	8 3/4	10	12 1/2
	$f_{cmin}$	0.70	0.70	0.70	0.70	0.70	0.70	0.70	0.70
1		0.70							
1 1/2		0.80	0.70						
2		0.90	0.77	0.70					
2 1/2		1.00	0.83	0.75	0.70				
3			0.90	0.80	0.74	0.70			
3 1/2			0.97	0.85	0.78	0.73	0.70		
3 3/4			1.00	0.88	0.80	0.75	0.71		
4				0.90	0.82	0.77	0.73	0.70	
4 1/2				0.95	0.86	0.80	0.76	0.73	
5				1.00	0.90	0.83	0.79	0.75	0.70
5 1/2					0.94	0.87	0.81	0.78	0.72
6					0.98	0.90	0.84	0.80	0.74
6 1/4					1.00	0.92	0.86	0.81	0.75
6 1/2						0.93	0.87	0.83	0.76
7						0.97	0.90	0.85	0.78
7 1/2						1.00	0.93	0.88	0.80
8							0.96	0.90	0.82
8 1/2							0.99	0.93	0.84
8 3/4							1.00	0.94	0.85
10								1.00	0.90
12 1/2									1.00
15									

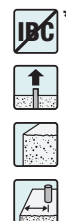

See footnotes below.

### Edge Distance Shear ( $f_c$ ) (Shear Applied Perpendicular to Edge)

Edge Dist. $c_{act}$ (in.)	Size	1/4	3/8	1/2	5/8	3/4	7/8	1	1 1/4
	$c_{cr}$	2 1/2	3 3/4	5	6 1/4	7 1/2	8 3/4	10	12 1/2
	$f_{cmin}$	0.30	0.30	0.30	0.30	0.30	0.30	0.30	0.30
1		0.30							
1 1/2		0.53	0.30						
2		0.77	0.46	0.30					
2 1/2		1.00	0.61	0.42	0.30				
3			0.77	0.53	0.39	0.30			
3 1/2			0.92	0.65	0.49	0.38	0.30		
3 3/4			1.00	0.71	0.53	0.42	0.33		
4				0.77	0.58	0.46	0.37	0.30	
4 1/2				0.88	0.67	0.53	0.43	0.36	
5				1.00	0.77	0.61	0.50	0.42	0.30
5 1/2					0.86	0.69	0.57	0.48	0.35
6					0.95	0.77	0.63	0.53	0.39
6 1/4					1.00	0.81	0.67	0.56	0.42
6 1/2						0.84	0.70	0.59	0.44
7						0.92	0.77	0.65	0.49
7 1/2						1.00	0.83	0.71	0.53
8							0.90	0.77	0.58
8 1/2							0.97	0.83	0.63
8 3/4							1.00	0.85	0.65
10								1.00	0.77
12 1/2									1.00
15									



1.  $c_{act}$  = actual edge distance at which anchor is installed (inches).
2.  $c_{cr}$  = critical edge distance for 100% load (inches).
3.  $c_{min}$  = minimum edge distance for reduced load (inches).
4.  $f_c$  = adjustment factor for allowable load at actual edge distance.
5.  $f_{c_{cr}}$  = adjustment factor for allowable load at critical edge distance.  $f_{c_{cr}}$  is always = 1.00.
6.  $f_{c_{min}}$  = adjustment factor for allowable load at minimum edge distance.
7.  $f_c = f_{c_{min}} + [(1 - f_{c_{min}}) (c_{act} - c_{min}) / (c_{cr} - c_{min})]$ .

### Load-Adjustment Factors for Reduced Spacing:

Critical spacing is listed in the load tables. No adjustment in load is required when the anchors are spaced at critical spacing. No additional testing has been performed to determine the adjustment factors for spacing dimensions less than those listed in the load tables.

\* See p. 12 for an explanation of the load table icons.

# Wedge-All® Design Information — Concrete

## Allowable Load-Adjustment Factors for Carbon-Steel and Stainless-Steel Wedge-All Anchors in Normal-Weight Concrete: Edge Distance and Shear Load Applied Parallel to Edge

### How to use these charts:

1. The following tables are for reduced edge distance.
2. Locate the anchor size to be used for a shear load application.
3. Locate the edge distance ( $C_{act||}$ ) at which the anchor is to be installed.
4. The load adjustment factor ( $\phi_{c||}$ ) is the intersection of the row and column.
5. Multiply the allowable load by the applicable load adjustment factor.
6. Reduction factors for multiple edges are multiplied together.

Edge Distance Shear ( $f_{c||}$ ) (Shear Applied Parallel to Edge with End Distance  $\geq ED_{min}$ )

Edge Dist. $C_{act  }$ (in.)	Size	1/4	3/8	1/2	5/8	3/4	7/8	1	1 1/4
	<i>E</i>	2 1/4	3 3/8	4 1/2	5 1/2	6 3/4	7 7/8	9	9 1/2
	<i>ED<sub>min</sub></i>	9	13 1/2	18	22	27	31 1/2	36	38
	<i>C<sub>crit  </sub></i>	2 1/2	3 3/4	5	6 1/4	7 1/2	8 3/4	10	12 1/2
	<i>C<sub>min  </sub></i>	1	1 1/2	2	2 1/2	3	3 1/2	4	5
	<i>f<sub>cmin  </sub></i>	1.00	0.93	0.70	0.62	0.62	0.62	0.62	0.62
1		1.00							
1 1/2		1.00	0.93						
2		1.00	0.95	0.70					
2 1/2		1.00	0.96	0.75	0.62				
3			0.98	0.80	0.67	0.62			
3 1/2			0.99	0.85	0.72	0.66	0.62		
4			1.00	0.90	0.77	0.70	0.66	0.62	
5				1.00	0.87	0.79	0.73	0.68	0.62
6					0.97	0.87	0.80	0.75	0.67
7					1.00	0.96	0.87	0.81	0.72
8						1.00	0.95	0.87	0.77
9							1.00	0.94	0.82
10								1.00	0.87
11									0.92
12									0.97
13									1.00

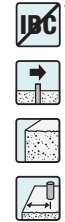

1. Table is not applicable to anchors with  $ED < ED_{min}$ . Factors from this table may not be combined with load-adjustment factors for shear loads applied perpendicular to edge.
2.  $C_{act||}$  = actual edge distance (measured perpendicular to direction of shear load) at which anchor is installed (inches).
3.  $C_{crit||}$  = critical edge distance (measured perpendicular to direction of shear load) for 100% load (inches).
4.  $C_{min||}$  = minimum edge distance (measured perpendicular to direction of shear load) for reduced load (inches).
5.  $ED$  = actual end distance (measured parallel to direction of shear load) at which anchor is installed (inches).
6.  $ED_{min}$  = minimum edge distance (measured parallel to direction of shear load).
7.  $f_{c||}$  = adjustment factor for allowable load at actual edge distance.
8.  $f_{ccrit||}$  = adjustment factor for allowable load at critical edge distance.  $f_{ccrit||}$  is always = 1.00.
9.  $f_{cmin||}$  = adjustment factor for allowable load at minimum edge distance.
10.  $f_{c||} = f_{cmin||} + [(1 - f_{cmin||})(C_{act||} - C_{min||}) / (C_{crit||} - C_{min||})]$ .

\* See p. 12 for an explanation of the load table icons.

# Wedge-All® Design Information — Concrete

## Allowable Load-Adjustment Factors for Carbon-Steel and Stainless-Steel Wedge-All Anchors in Normal-Weight Concrete: Spacing, Tension Loads

### How to use these charts:

1. The following tables are for reduced spacing.
2. Locate the anchor size to be used for a tension load application.
3. Locate the anchor embedment (E) used for a tension load application.
4. Locate the spacing ( $s_{act}$ ) at which the anchor is to be installed.
5. The load adjustment factor ( $f_s$ ) is the intersection of the row and column.
6. Multiply the allowable load by the applicable load adjustment factor.
7. Reduction factors for multiple spacings are multiplied together.

### Spacing Tension ( $f_s$ )

$s_{act}$ (in.)	Dia.	¼			⅜			½			¾		
	E	1⅞	2¼	1¾	2⅝	3⅞	2¼	3⅞	4½	2¾	4½	5½	
	$s_{cr}$	1⅝	3⅞	2⅜	3⅝	4¾	3⅞	4¾	6¼	3⅞	6¼	7¾	
	$s_{min}$	⅝	1⅞	⅞	1⅞	1¾	1⅞	1¾	2¼	1⅞	2¼	2¾	
	$f_{smin}$	0.43	0.70	0.43	0.43	0.70	0.43	0.43	0.70	0.43	0.43	0.70	
¾		0.50											
1		0.64		0.48									
1¼		0.79	0.72	0.57			0.47						
1½		0.93	0.76	0.67	0.46		0.54			0.46			
1¾		1.00	0.79	0.76	0.53	0.70	0.61	0.43		0.52			
2			0.83	0.86	0.59	0.73	0.68	0.48		0.57			
2¼			0.87	0.95	0.65	0.75	0.75	0.53	0.70	0.63	0.43		
2½			0.91	1.00	0.72	0.78	0.82	0.57	0.72	0.69	0.47		
2¾			0.94		0.78	0.80	0.89	0.62	0.74	0.74	0.50	0.70	
3			0.98		0.84	0.83	0.96	0.67	0.76	0.80	0.54	0.72	
3½			1.00		0.97	0.88	1.00	0.76	0.79	0.91	0.61	0.75	
4					1.00	0.93		0.86	0.83	1.00	0.68	0.78	
4½						0.98		0.95	0.87		0.75	0.81	
5						1.00		1.00	0.91		0.82	0.84	
6									0.98		0.96	0.90	
7									1.00		1.00	0.96	
8												1.00	



See footnotes below.

### Spacing Tension ( $f_s$ )

$s_{act}$ (in.)	Dia.	¾			7/8		1		1¼	
	E	3⅞	5	6¼	3⅞	7⅞	4½	9	5⅞	9½
	$s_{cr}$	4¾	7	9½	5⅞	11	6¼	12⅝	7⅞	13¼
	$s_{min}$	1¾	2½	3⅞	2	4	2¼	4½	2⅞	4¾
	$f_{smin}$	0.43	0.43	0.70	0.43	0.70	0.43	0.70	0.43	0.70
2		0.48			0.43					
3		0.67	0.49		0.60		0.54		0.46	
4		0.86	0.62	0.73	0.77	0.70	0.68		0.57	
5		1.00	0.75	0.78	0.94	0.74	0.82	0.72	0.68	0.71
6			0.87	0.83	1.00	0.79	0.96	0.76	0.79	0.74
7			1.00	0.88		0.83	1.00	0.79	0.90	0.78
8				0.93		0.87		0.83	1.00	0.81
9				0.98		0.91		0.87		0.85
10				1.00		0.96		0.90		0.89
11						1.00		0.94		0.92
12								0.98		0.96
13								1.00		0.99
14										1.00



1. E = Embedment depth (inches).
2.  $s_{act}$  = actual spacing distance at which anchors are installed (inches).
3.  $s_{cr}$  = critical spacing distance for 100% load (inches).
4.  $s_{min}$  = minimum spacing distance for reduced load (inches).
5.  $f_s$  = adjustment factor for allowable load at actual spacing distance.
6.  $f_{scr}$  = adjustment factor for allowable load at critical spacing distance.  $f_{scr}$  is always = 1.00.
7.  $f_{smin}$  = adjustment factor for allowable load at minimum spacing distance.
8.  $f_s = f_{smin} + [(1 - f_{smin}) (s_{act} - s_{min}) / (s_{cr} - s_{min})]$ .

\* See p. 12 for an explanation of the load table icons.

# Wedge-All® Design Information — Concrete

## Allowable Load-Adjustment Factors for Carbon-Steel and Stainless-Steel Wedge-All Anchors in Normal-Weight Concrete: Spacing, Shear Loads

### How to use these charts:

1. The following tables are for reduced spacing.
2. Locate the anchor size to be used for a shear load application.
3. Locate the anchor embedment (E) used for a shear load application.
4. Locate the spacing ( $s_{act}$ ) at which the anchor is to be installed.
5. The load adjustment factor ( $f_s$ ) is the intersection of the row and column.
6. Multiply the allowable load by the applicable load adjustment factor.
7. Reduction factors for multiple spacings are multiplied together.

### Spacing Shear ( $f_s$ )

$s_{act}$ (in.)	Dia.	¼			⅜			½			⅝		
	E	1⅞	2¼	1¾	2⅝	3⅞	2¼	3⅞	4½	2¾	4½	5½	
	$s_{cr}$	1⅞	3⅞	2⅞	3⅝	4¾	3⅞	4¾	6¼	3⅞	6¼	7¾	
	$s_{min}$	⅝	1⅞	⅞	1⅞	1¾	1⅞	1¾	2¼	1⅞	2¼	2¾	
	$f_{smin}$	0.79	0.79	0.79	0.79	0.79	0.79	0.79	0.79	0.79	0.79	0.79	
¾		0.82											
1		0.87		0.81									
1¼		0.92	0.80	0.84			0.80						
1½		0.97	0.83	0.88	0.80		0.83			0.80			
1¾		1.00	0.86	0.91	0.83	0.79	0.86	0.79		0.82			
2			0.88	0.95	0.85	0.81	0.88	0.81		0.84			
2¼			0.91	0.98	0.87	0.83	0.91	0.83	0.79	0.86	0.79		
2½			0.93	1.00	0.90	0.84	0.93	0.84	0.80	0.88	0.80		
2¾			0.96		0.92	0.86	0.96	0.86	0.82	0.91	0.82	0.79	
3			0.99		0.94	0.88	0.99	0.88	0.83	0.93	0.83	0.80	
3½			1.00		0.99	0.91	1.00	0.91	0.86	0.97	0.86	0.82	
4					1.00	0.95		0.95	0.88	1.00	0.88	0.84	
4½						0.98		0.98	0.91		0.91	0.86	
5								1.00	0.93		0.93	0.88	
6									0.99		0.99	0.93	
7									1.00		1.00	0.97	
8												1.00	

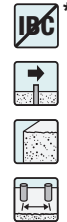

See notes below.

### Spacing Shear ( $f_s$ )

$s_{act}$ (in.)	Dia.	¼			⅜		1		1¼	
	E	3⅞	5	6¼	3⅞	7⅞	4½	9	5⅞	9½
	$s_{cr}$	4¾	7	9½	5⅞	11	6¼	12⅝	7⅞	13¼
	$s_{min}$	1¾	2½	3⅞	2	4	2¼	4½	2⅞	4¾
	$f_{smin}$	0.79	0.79	0.79	0.79	0.79	0.79	0.79	0.79	0.79
2		0.81			0.79					
3		0.88	0.81		0.85		0.83		0.80	
4		0.95	0.86	0.81	0.91	0.79	0.88		0.84	
5		1.00	0.91	0.85	0.98	0.82	0.93	0.80	0.88	0.80
6			0.95	0.88	1.00	0.85	0.99	0.83	0.92	0.82
7			1.00	0.91		0.88	1.00	0.85	0.96	0.85
8				0.95		0.91		0.88	1.00	0.87
9				0.98		0.94		0.91		0.90
10				1.00		0.97		0.93		0.92
11						1.00		0.96		0.94
12								0.98		0.97
13								1.00		0.99
14										1.00

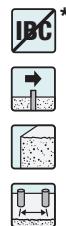

1. E = Embedment depth (inches).
2.  $s_{act}$  = actual spacing distance at which anchors are installed (inches).
3.  $s_{cr}$  = critical spacing distance for 100% load (inches).
4.  $s_{min}$  = minimum spacing distance for reduced load (inches).
5.  $f_s$  = adjustment factor for allowable load at actual spacing distance.
6.  $f_{s_{cr}}$  = adjustment factor for allowable load at critical spacing distance.  $f_{s_{cr}}$  is always = 1.00.
7.  $f_{s_{min}}$  = adjustment factor for allowable load at minimum spacing distance.
8.  $f_s = f_{s_{min}} + [(1 - f_{s_{min}})(s_{act} - s_{min}) / (s_{cr} - s_{min})]$ .

\* See p. 12 for an explanation of the load table icons.

# Wedge-All® Design Information — Concrete and Masonry

## Allowable Load-Adjustment Factors for Carbon-Steel Wedge-All Anchors in Sand-Lightweight Concrete: Edge Distance, Tension and Shear Loads

### How to use these charts:

1. The following tables are for reduced edge distance.
2. Locate the anchor size to be used for either a tension and/or shear load application.
3. Locate the edge distance ( $c_{act}$ ) at which the anchor is to be installed.
4. The load adjustment factor ( $f_c$ ) is the intersection of the row and column.
5. Multiply the allowable load by the applicable load adjustment factor.
6. Reduction factors for multiple edges are multiplied together.

### Edge Distance Tension ( $f_c$ )

Edge Dist. $c_{act}$ (in.)	Size	1/4	1/2	5/8	3/4
	$c_{cr}$	3 3/8	6 3/4	8 3/8	10
	$c_{min}$	1 3/8	2 3/4	3 3/8	4
	$f_{cmin}$	0.70	0.70	0.70	0.70
1 3/8		0.70			
1 1/2		0.72			
2		0.79			
2 1/2		0.87			
2 3/4		0.91	0.70		
3		0.94	0.72		
3 3/8		1.00	0.75	0.70	
3 1/2			0.76	0.71	
4			0.79	0.74	0.70
4 1/2			0.83	0.77	0.73
5			0.87	0.80	0.75
5 1/2			0.91	0.83	0.78
6			0.94	0.86	0.80
6 1/2			0.98	0.89	0.83
6 3/4			1.00	0.90	0.84
7				0.92	0.85
7 1/2				0.95	0.88
8				0.98	0.90
8 3/8				1.00	0.92
8 1/2					0.93
9					0.95
9 1/2					0.98
10					1.00



See footnotes below.

### Edge Distance Shear ( $f_c$ ) (Shear Applied Perpendicular to Edge)

Edge Dist. $c_{act}$ (in.)	Size	1/4	1/2	5/8	3/4
	$c_{cr}$	3 3/8	6 3/4	8 3/8	10
	$c_{min}$	1 3/8	2 3/4	3 3/8	4
	$f_{cmin}$	0.30	0.30	0.30	0.30
1 3/8		0.30			
1 1/2		0.34			
2		0.52			
2 1/2		0.69			
2 3/4		0.78	0.30		
3		0.87	0.34		
3 3/8		1.00	0.41	0.30	
3 1/2			0.43	0.32	
4			0.52	0.39	0.30
4 1/2			0.61	0.46	0.36
5			0.69	0.53	0.42
5 1/2			0.78	0.60	0.48
6			0.87	0.67	0.53
6 1/2			0.96	0.74	0.59
6 3/4			1.00	0.77	0.62
7				0.81	0.65
7 1/2				0.88	0.71
8				0.95	0.77
8 3/8				1.00	0.81
8 1/2					0.83
9					0.88
9 1/2					0.94
10					1.00



See footnotes below.

## Load Adjustment Factors for Carbon-Steel Wedge-All® Anchors in Face-of-Wall Installation in 8" Grout-Filled CMU: Edge Distance, Tension and Shear Loads

### Edge Distance Tension ( $f_c$ )

Edge Dist. $c_{act}$ (in.)	Size	3/8	1/2	5/8	3/4
	$c_{cr}$	10 1/2	14	17 1/2	21
	$c_{min}$	4	4	4	4
	$f_{cmin}$	1.00	1.00	0.80	0.80
4		1.00	1.00	0.80	0.80
6		1.00	1.00	0.83	0.82
8		1.00	1.00	0.86	0.85
10 1/2		1.00	1.00	0.90	0.88
12			1.00	0.92	0.89
14			1.00	0.95	0.92
16				0.98	0.94
17 1/2				1.00	0.96
21					1.00

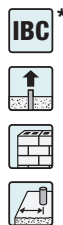

### Load-Adjustment Factors for Reduced Spacing:

Critical spacing is listed in the load tables. No adjustment in load is required when the anchors are spaced at critical spacing. No additional testing has been performed to determine the adjustment factors for spacing dimensions less than those listed in the load tables.

### Edge Distance Shear ( $f_c$ )

Edge Dist. $c_{act}$ (in.)	Size	3/8	1/2	5/8	3/4
	$c_{cr}$	10 1/2	14	17 1/2	21
	$c_{min}$	4	4	4	4
	$f_{cmin}$	0.79	0.52	0.32	0.32
4		0.79	0.52	0.32	0.32
6		0.85	0.62	0.42	0.40
8		0.92	0.71	0.52	0.48
10 1/2		1.00	0.83	0.65	0.58
12			0.90	0.72	0.64
14			1.00	0.82	0.72
16				0.92	0.80
17 1/2				1.00	0.86
21					1.00



1.  $c_{act}$  = actual edge distance at which anchor is installed (inches).
2.  $c_{cr}$  = critical edge distance for 100% load (inches).
3.  $c_{min}$  = minimum edge distance for reduced load (inches).
4.  $f_c$  = adjustment factor for allowable load at actual edge distance.
5.  $f_{c_{cr}}$  = adjustment factor for allowable load at critical edge distance.  $f_{c_{cr}}$  is always = 1.00.
6.  $f_{c_{min}}$  = adjustment factor for allowable load at minimum edge distance.
7.  $f_c = f_{c_{min}} + [(1 - f_{c_{min}})(c_{act} - c_{min}) / (c_{cr} - c_{min})]$ .

\* See p. 12 for an explanation of the load table icons.

# Sleeve-All® Sleeve Anchor

Sleeve-All expanding anchors are pre-assembled, expanding sleeve anchors for use in all types of solid base materials. This anchor is available in acorn, hex, rod coupler or flat head style for a wide range of applications.

**Codes:** FM 3017082, 3026805 and 3029959 (carbon steel 3/8" – 1/2" diameter); Underwriters Laboratories File Ex3605 (3/8" – 3/4" diameter); Multiple DOT listings; meets the requirements of Federal Specification A-A-1922A

**Material:** Carbon steel or Type 304 stainless steel

**Coating:** Carbon steel anchors are zinc plated

## Installation

1. Drill a hole in the base material using a carbide drill bit the same diameter as the nominal diameter of the anchor to be installed.
2. Drill the hole to the specified embedment depth, and blow it clean using compressed air. (Overhead installations need not be blown clean.) Alternatively, drill the hole deep enough to accommodate embedment depth and the dust from drilling.
3. Place the anchor in the fixture, and drive it into the hole until the washer and nut are tight against the fixture.
4. Tighten to required installation torque.

**Caution:** Oversized holes will make it difficult to set the anchor and will reduce the anchor's load capacity.

## Installation Sequence

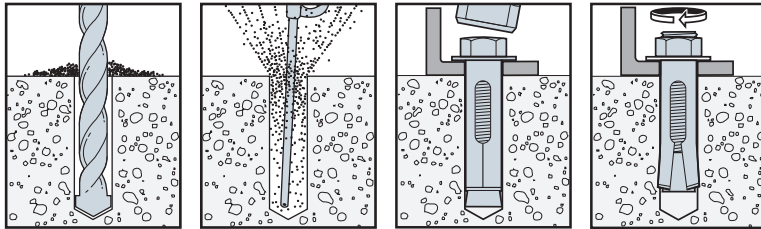

## Material Specifications

Anchor Component	Zinc-Plated Carbon Steel	304 Stainless Steel
Anchor Body	Material meets minimum 50,000 psi tensile	Type 304
Sleeve	SAE J403, Grade 1008 cold-rolled steel	Type 304
Nut	Commercial Grade, meets requirements of ASTM A563 Grade A	Type 304
Washer	SAE J403, Grade 1008/1010 cold-rolled steel	Type 304

## Sleeve-All Anchor Installation Data

Sleeve-All Diameter (in.)	1/4	5/16	3/8	1/2	5/8	3/4
Installation Torque (ft.-lb.)	5	8	15	25	50	90
Drill Bit Size (in.)	1/4	5/16	3/8	1/2	5/8	3/4
Wrench Size <sup>1</sup> (in.)	3/8	7/16	1/2	9/16	3/4	15/16
Wrench Size for Coupler Nut (in.)			1/2	5/8	3/4	—

1. Applies to acorn- and hex-head configurations only.



Hex

Acorn



Rod Coupler

Flat Head  
(Phillips drive)





# Sleeve-All® Sleeve Anchor

## Sleeve-All Anchor Product Data — Zinc-Plated Carbon Steel

Size (in.)	Model No.	Head Style	Bolt Diameter – Threads per Inch	Max. Fixture Thickness (in.)	Quantity	
					Box	Carton
1/4 x 1 3/8	SL25138A	Acorn Head	3/16-24	1/4	100	500
1/4 x 2 1/4	SL25214A			1 1/8	100	500
5/16 x 1 1/2	SL31112H	Hex Head	1/4-20	3/8	100	500
5/16 x 2 1/2	SL31212H			1 1/16	50	250
3/8 x 1 7/8	SL37178H		5/16-18	3/8	50	250
3/8 x 3	SL37300H			1 1/2	50	200
3/8 x 4	SL37400H			2 1/4	50	200
1/2 x 2 1/4	SL50214H			1/2	50	200
1/2 x 3	SL50300H		3/8-16	3/4	25	100
1/2 x 4	SL50400H			1 3/4	25	100
1/2 x 6	SL50600H			3 3/8	20	80
5/8 x 2 1/4	SL62214H			1/2	25	100
5/8 x 3	SL62300H		1/2-13	3/4	20	80
5/8 x 4 1/4	SL62414H			1 1/2	10	40
5/8 x 6	SL62600H			3 1/4	10	40
3/4 x 2 1/2	SL75212H			1/2	10	40
3/4 x 4 1/4	SL75414H		5/8-11	7/8	10	40
3/4 x 6 1/4	SL75614H			2 7/8	5	20
1/4 x 2	SL25200PF	Phillips Flat Head	3/16-24	7/8	100	500
1/4 x 3	SL25300PF			1 7/8	50	250
5/16 x 2 1/2	SL31212PF		1/4-20	1 1/16	50	250
5/16 x 3 1/2	SL31312PF			2 1/16	50	250
3/8 x 2 3/4	SL37234PF		5/16-18	1 1/4	50	200
3/8 x 4	SL37400PF			2 1/2	50	200
3/8 x 5	SL37500PF			3 1/2	50	200
3/8 x 6	SL37600PF			4 1/2	50	200

## Sleeve-All Anchor Product Data — Stainless Steel

Size (in.)	Model No.	Head Style	Bolt Diameter – Threads per Inch	Max. Fixture Thickness (in.)	Quantity	
					Box	Carton
3/8 x 1 7/8	SL37178HSS	Hex Head	5/16-18	3/8	50	250
3/8 x 3	SL37300HSS			1 1/2	50	200
1/2 x 3	SL50300HSS		3/8-16	3/4	25	100
1/2 x 4	SL50400HSS			1 3/4	25	100

## Sleeve-All Anchor (with rod coupler) Product Data — Zinc-Plated Carbon Steel

Size (in.)	Model No.	Accepts Rod Diameter (in.)	Wrench Size	Quantity	
				Box	Carton
3/8 x 1 7/8	SL37178C	3/8	1/2	50	200
1/2 x 2 1/4	SL50214C	1/2	5/8	25	100
5/8 x 2 1/4	SL62214C	5/8	3/4	20	80

## Length Identification Head Marks on Sleeve-All Anchors (corresponds to length of anchor — inches)

Mark	A	B	C	D	E	F	G	H	I	J	K	L	M	N	O	P	Q	R	S	T	U	V	W	X	Y	Z
From	1 1/2	2	2 1/2	3	3 1/2	4	4 1/2	5	5 1/2	6	6 1/2	7	7 1/2	8	8 1/2	9	9 1/2	10	11	12	13	14	15	16	17	18
Up to but Not Including	2	2 1/2	3	3 1/2	4	4 1/2	5	5 1/2	6	6 1/2	7	7 1/2	8	8 1/2	9	9 1/2	10	11	12	13	14	15	16	17	18	19

C-A-2021 © 2021 SIMPSON STRONG-TIE COMPANY, INC.

Mechanical Anchors

# Sleeve-All® Design Information — Concrete and Masonry

Mechanical Anchors

Allowable Tension and Shear Loads for Sleeve-All in Normal-Weight Concrete

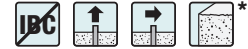

Size in. (mm)	Embed. Depth in. (mm)	Critical Edge Dist. in. (mm)	Critical Spacing Dist. in. (mm)	Tension Load						Shear Load			Install. Torque ft.-lb. (N-m)
				f <sub>c</sub> ≥ 2,000 psi (13.8 MPa) Concrete			f <sub>c</sub> ≥ 4,000 psi (27.6 MPa) Concrete			f <sub>c</sub> ≥ 2,000 psi (13.8 MPa) Concrete			
				Ultimate lb. (kN)	Std. Dev. lb. (kN)	Allow. lb. (kN)	Ultimate lb. (kN)	Std. Dev. lb. (kN)	Allow. lb. (kN)	Ultimate lb. (kN)	Std. Dev. lb. (kN)	Allow. lb. (kN)	
1/4 (6.4)	1 1/8 (29)	2 1/2 (64)	4 1/2 (114)	880 (3.9)	94 (0.4)	220 (1.0)	1,320 (5.9)	189 (0.8)	330 (1.5)	1,440 (6.4)	90 (0.4)	360 (1.6)	5 (7)
5/16 (7.9)	1 (25)	3 1/8 (79)	5 3/4 (146)	930 (4.1)	201 (0.9)	230 (1.0)	1,095 (4.9)	118 (0.5)	275 (1.2)	1,480 (6.6)	264 (1.2)	370 (1.6)	8 (11)
	1 7/16 (37)	3 1/8 (79)	5 3/4 (146)	1,120 (5.0)	113 (0.5)	280 (1.2)	1,320 (5.9)	350 (1.6)	330 (1.5)	2,160 (9.6)	113 (0.5)	540 (2.4)	8 (11)
3/8 (9.5)	1 1/2 (38)	3 3/4 (95)	6 (152)	1,600 (7.1)	294 (1.3)	400 (1.8)	2,680 (11.9)	450 (2.0)	670 (3.0)	3,080 (13.7)	223 (1.0)	770 (3.4)	15 (20)
1/2 (12.7)	1 3/4 (45)	5 (127)	9 (229)	2,900 (12.9)	369 (1.6)	725 (3.2)	3,480 (15.5)	529 (2.4)	870 (3.9)	4,250 (18.9)	659 (2.9)	1,060 (4.7)	25 (34)
	2 1/4 (57)	5 (127)	9 (229)	3,160 (14.1)	254 (1.1)	790 (3.5)	4,760 (21.2)	485 (2.2)	1,190 (5.3)	5,000 (22.2)	473 (2.1)	1,250 (5.6)	25 (34)
5/8 (15.9)	1 3/4 (45)	6 1/4 (159)	11 (279)	3,200 (14.2)	588 (2.6)	800 (3.6)	3,825 (17.0)	243 (1.1)	955 (4.2)	4,625 (20.6)	747 (3.3)	1,155 (5.1)	50 (68)
	2 3/4 (70)	6 1/4 (159)	11 (279)	4,200 (18.7)	681 (3.0)	1,050 (4.7)	6,160 (27.4)	1,772 (7.9)	1,540 (6.9)	8,520 (37.9)	713 (3.2)	2,130 (9.5)	50 (68)
3/4 (19.1)	2 (51)	7 1/2 (191)	13 1/2 (343)	3,200 (14.2)	588 (2.6)	800 (3.6)	4,465 (19.9)	1,017 (4.5)	1,115 (5.0)	5,080 (22.6)	771 (3.4)	1,270 (5.6)	90 (122)
	3 3/8 (86)	7 1/2 (191)	13 1/2 (343)	6,400 (28.5)	665 (3.0)	1,600 (7.1)	9,520 (42.3)	674 (3.0)	2,380 (10.6)	10,040 (44.7)	955 (4.2)	2,510 (11.2)	90 (122)

- The tabulated allowable loads are based on a safety factor of 4.0.
- Allowable loads may not be increased for short-term loading due to wind or seismic forces.
- Refer to allowable load-adjustment factors for spacing and edge distance on p. 140.
- Drill bit diameter used in base material corresponds to nominal anchor diameter.
- Allowable tension loads may be linearly interpolated between concrete strengths listed.
- The minimum concrete thickness is 1 1/2 times the embedment depth.

Allowable Tension and Shear Loads for 3/8" Sleeve-All in Grout-Filled CMU (Anchor Installed in Horizontal Mortar Joint or Face Shell)



Size in. (mm)	Embed. Depth in. (mm)	Min. Edge Dist. in. (mm)	Min. End Dist. in. (mm)	Min. Spacing in. (mm)	Tension Load		Shear Load		Install. Torque ft.-lb. (N-m)
					Ultimate lb. (kN)	Allow. lb. (kN)	Ultimate lb. (kN)	Allow. lb. (kN)	
3/8 (9.5)	1 1/2 (38)	16 (406)	16 (406)	24 (610)	2,000 (8.9)	400 (1.8)	2,300 (10.2)	460 (2.0)	15 (20)

See footnotes on p. 139.

\* See p. 12 for an explanation of the load table icons.

# Sleeve-All® Design Information — Concrete and Masonry



Allowable Tension and Shear Loads for Sleeve-All in Grout-Filled CMU

Size in. (mm)	Embed. Depth in. (mm)	Min. Edge Dist. in. (mm)	Min. End Dist. in. (mm)	Min. Spacing in. (mm)	Tension Load		Shear Load		Install. Torque ft.-lb. (N-m)
					Ultimate lb. (kN)	Allow. lb. (kN)	Ultimate lb. (kN)	Allow. lb. (kN)	
<b>Anchor Installed in a Single Face Shell</b>									
3/8 (9.5)	1 1/2 (38)	12 (305)	12 (305)	24 (610)	1,746 (7.8)	350 (1.6)	2,871 (12.8)	575 (2.6)	15 (20)
1/2 (12.7)	2 1/4 (57)	12 (305)	12 (305)	24 (610)	3,384 (15.1)	675 (3.0)	5,670 (25.2)	1,135 (5.0)	25 (34)
5/8 (15.9)	2 3/4 (70)	12 (305)	12 (305)	24 (610)	3,970 (17.7)	795 (3.5)	8,171 (36.3)	1,635 (7.3)	50 (68)
3/4 (19.1)	3 3/8 (86)	12 (305)	12 (305)	24 (610)	6,395 (28.4)	1,280 (5.7)	12,386 (55.1)	2,475 (11.0)	90 (122)
<b>Anchor Installed in Mortar "T" Joint</b>									
3/8 (9.5)	1 1/2 (38)	8 (203)	8 (203)	24 (610)	1,927 (8.6)	385 (1.7)	3,436 (15.3)	685 (3.0)	15 (20)
1/2 (12.7)	2 1/4 (57)	8 (203)	8 (203)	24 (610)	3,849 (17.1)	770 (3.4)	5,856 (26.0)	1,170 (5.2)	25 (34)
5/8 (15.9)	2 3/4 (70)	8 (203)	8 (203)	24 (610)	4,625 (20.6)	925 (4.1)	7,040 (31.3)	1,410 (6.3)	50 (68)
3/4 (19.1)	3 3/8 (86)	8 (203)	8 (203)	24 (610)	5,483 (24.4)	1,095 (4.9)	7,869 (35.0)	1,575 (7.0)	90 (122)

- The tabulated allowable loads are based on a safety factor of 5.0.
- Listed loads may be applied to installations through a face shell with the following placement guidelines:
  - Minimum 3" from vertical mortar joint.
  - Minimum 1" from vertical cell centerline.
- Values for 6"- and 8"-wide concrete masonry units (CMU) with a minimum specified compressive strength of masonry,  $f_m$ , at 28 days is 1,500 psi.
- Embedment depth is measured from the outside face of the concrete masonry unit.
- Drill bit diameter used in base material corresponds to nominal anchor diameter.

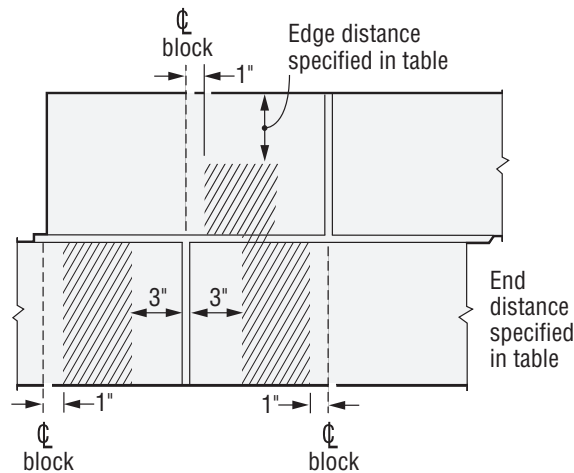

**Face Shell Installation**  
Allowable anchor placement in grout-filled CMU shown by shaded areas.

\* See p. 12 for an explanation of the load table icons.

# Sleeve-All® Design Information — Concrete

## Allowable Load-Adjustment Factors for Sleeve-All Anchors in Normal-Weight Concrete: Edge Distance and Spacing, Tension and Shear Loads

### How to use these charts:

- The following tables are for reduced edge distance and spacing.
- Locate the anchor size to be used for either a tension and/or shear load application.
- Locate the edge distance ( $c_{act}$ ) or spacing ( $s_{act}$ ) at which the anchor is to be installed.
- The load adjustment factor ( $f_c$  or  $f_s$ ) is the intersection of the row and column.
- Multiply the allowable load by the applicable load adjustment factor.
- Reduction factors for multiple edges or spacing are multiplied together.

### Edge Distance Tension ( $f_c$ )

Edge Dist. $c_{act}$ (in.)	Size	1/4	5/16	3/8	1/2	5/8	3/4
	$c_{cr}$	2 1/2	3 1/8	3 3/4	5	6 1/4	7 1/2
	$c_{min}$	1 1/4	1 9/16	1 7/8	2 1/2	3 1/8	3 3/4
	$f_{cmin}$	0.60	0.60	0.60	0.60	0.60	0.60
1 1/4		0.60					
1 1/2		0.68					
1 9/16		0.70	0.60				
1 7/8		0.80	0.68	0.60			
2		0.84	0.71	0.63			
2 1/2		1.00	0.84	0.73	0.60		
3			0.97	0.84	0.68		
3 1/8			1.00	0.87	0.70	0.60	
3 1/2				0.95	0.76	0.65	
3 3/4				1.00	0.80	0.68	0.60
4					0.84	0.71	0.63
4 1/2					0.92	0.78	0.68
5					1.00	0.84	0.73
5 1/2						0.90	0.79
6						0.97	0.84
6 1/4						1.00	0.87
6 1/2							0.89
7							0.95
7 1/2							1.00

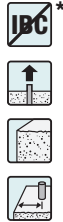

### Spacing Tension and Shear ( $f_s$ )

$s_{act}$ (in.)	Size	1/4	5/16	3/8	1/2	5/8	3/4
	$s_{cr}$	4 1/2	5 3/4	6	9	11	13 1/2
	$s_{min}$	2 1/4	2 7/8	3	4 1/2	5 1/2	6 3/4
	$f_{smin}$	0.50	0.50	0.50	0.50	0.50	0.50
2 1/4		0.50					
2 1/2		0.56					
2 7/8		0.64	0.50				
3		0.67	0.52	0.50			
3 1/2		0.78	0.61	0.58			
4		0.89	0.70	0.67			
4 1/2		1.00	0.78	0.75	0.50		
5			0.87	0.83	0.56		
5 1/2			0.96	0.92	0.61	0.50	
5 3/4			1.00	0.96	0.64	0.52	
6				1.00	0.67	0.55	
6 1/2					0.72	0.59	
6 3/4					0.75	0.61	0.50
7					0.78	0.64	0.52
8					0.89	0.73	0.59
9					1.00	0.82	0.67
10						0.91	0.74
11						1.00	0.81
12							0.89
13							0.96
13 1/2							1.00



See footnotes below.

### Edge Distance Shear ( $f_c$ )

Edge Dist. $c_{act}$ (in.)	Size	1/4	5/16	3/8	1/2	5/8	3/4
	$c_{cr}$	2 1/2	3 1/8	3 3/4	5	6 1/4	7 1/2
	$c_{min}$	1 1/4	1 9/16	1 7/8	2 1/2	3 1/8	3 3/4
	$f_{cmin}$	0.30	0.30	0.30	0.30	0.30	0.30
1 1/4		0.30					
1 1/2		0.44					
1 9/16		0.48	0.30				
1 7/8		0.65	0.44	0.30			
2		0.72	0.50	0.35			
2 1/2		1.00	0.72	0.53	0.30		
3			0.94	0.72	0.44		
3 1/8			1.00	0.77	0.48	0.30	
3 1/2				0.91	0.58	0.38	
3 3/4				1.00	0.65	0.44	0.30
4					0.72	0.50	0.35
4 1/2					0.86	0.61	0.44
5					1.00	0.72	0.53
5 1/2						0.83	0.63
6						0.94	0.72
6 1/4						1.00	0.77
6 1/2							0.81
7							0.91
7 1/2							1.00

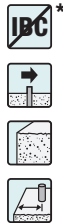

- E = Embedment depth (inches).
- $s_{act}$  = actual spacing distance at which anchors are installed (inches).
- $s_{cr}$  = critical spacing distance for 100% load (inches).
- $s_{min}$  = minimum spacing distance for reduced load (inches).
- $f_s$  = adjustment factor for allowable load at actual spacing distance.
- $f_{scr}$  = adjustment factor for allowable load at critical spacing distance.  $f_{scr}$  is always = 1.00.
- $f_{smin}$  = adjustment factor for allowable load at minimum spacing distance.
- $f_s = f_{smin} + [(1 - f_{smin})(s_{act} - s_{min}) / (s_{cr} - s_{min})]$ .

- $c_{act}$  = actual edge distance at which anchor is installed (inches).
- $c_{cr}$  = critical edge distance for 100% load (inches).
- $c_{min}$  = minimum edge distance for reduced load (inches).
- $f_c$  = adjustment factor for allowable load at actual edge distance.
- $f_{ccr}$  = adjustment factor for allowable load at critical edge distance.  $f_{ccr}$  is always = 1.00.
- $f_{cmin}$  = adjustment factor for allowable load at minimum edge distance.
- $f_c = f_{cmin} + [(1 - f_{cmin})(c_{act} - c_{min}) / (c_{cr} - c_{min})]$ .

\* See p. 12 for an explanation of the load table icons.

# Easy-Set Pin-Drive Expansion Anchor

The Easy-Set is a pin-drive expansion anchor for medium- and heavy-duty fastening applications into concrete. Integrated nut and washer help keep track of parts.

**Material:** Carbon steel

**Coating:** Yellow zinc dichromate plated

## Installation

**Caution:** Oversized holes in the base material will make it difficult to set the anchor and will reduce the anchor's load capacity.

1. Drill a hole in the base material using a carbide drill bit the same diameter as the nominal diameter of the anchor to be installed. Drill the hole to the specified embedment depth plus ¼" to allow for pin extension and blow it clean using compressed air. (Overhead installations need not be blown clean.) Alternatively, drill the hole deep enough to accommodate embedment depth and the dust from drilling.
2. Adjust the nut for required embedment. Place the anchor through the fixture and into the hole.
3. Hammer the center pin until the bottom of the head is flush with top of anchor.

## Installation Sequence

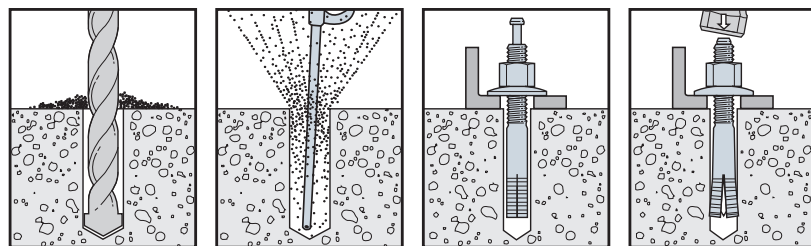

**Easy-Set  
(EZAC)**

## EZAC Product Data

Size (in.)	Model No.	Thread Length (in.)	Quantity	
			Box	Carton
¾ x 2¾	EZAC37238	1	50	250
¾ x 3½	EZAC37312	1½	50	250
¾ x 4¾	EZAC37434	1½	50	200
½ x 2¾	EZAC50234	1	25	125
½ x 3½	EZAC50312	1½	25	125
½ x 4¾	EZAC50434	1½	25	100
½ x 6	EZAC50600	2	25	100
⅝ x 4	EZAC62400	1½	15	60
⅝ x 4¾	EZAC62434	1½	15	60
⅝ x 6	EZAC62600	2	15	60

## Easy-Set Anchor Installation Data

Easy-Set Diameter (in.)	¾	½	⅝
Drill Bit Size (in.)	¾	½	⅝
Min. Fixture Hole Size (in.)	7/16	9/16	11/16
Wrench Size (in.)	9/16	¾	15/16

## EZAC Allowable Tension and Shear Loads in Normal-Weight Concrete

Size in.	Embed. Depth in. (mm)	Drill Bit Dia. in.	Critical Edge Dist. in. (mm)	Critical Spacing Dist. in. (mm)	Tension Load	Shear Load
					$f'_c \geq 2,000$ psi (13.8 MPa) Concrete	
					Allowable lb. (kN)	
¾	1¾ (44)	¾	2¾ (70)	5¼ (133)	630 (2.8)	645 (2.9)
½	2½ (64)	½	3¾ (86)	6¾ (171)	1,005 (4.5)	1,230 (5.5)
⅝	3 (76)	⅝	4¾ (108)	9 (229)	1,515 (6.7)	1,325 (5.9)



1. The allowable loads listed are based on a safety factor of 4.0.
2. 100% of the allowable load is permitted at critical spacing and critical edge distance. Allowable loads at lesser spacings and edge distance have not been determined.
3. The minimum concrete thickness is 1½ times the embedment depth.
4. Tension and shear loads for the EZAC anchor may be combined using the straight-line interaction equation ( $n = 1$ ).

\* See p. 12 for an explanation of the load table icons.

# Tie-Wire Wedge Anchor

The Simpson Strong-Tie tie-wire anchor is a wedge-style expansion anchor for use in normal-weight concrete or in concrete over steel deck. With a tri-segmented, dual-embossed clip, the tie-wire anchor is ideal for the installation of acoustic ceiling grid and is easily set with the claw of a hammer.

## Features

- ¼" eyelet for easy threading of wire
- Sets with claw of hammer
- Tri-segmented clip — each segment adjusts independently to hole irregularities
- Dual embossments on each clip segment enable the clip to undercut into the concrete, increasing follow-up expansion
- Wedge-style expansion anchor for use in normal weight concrete or concrete over steel deck

**Material:** Carbon steel

**Coating:** Zinc plated

## Installation

1. Drill a hole at least 1 ¼" deep using a ¼"-diameter carbide tipped bit.
2. Drive the anchor into the hole until the bottom of the head is flush with the base material.
3. Set the anchor by prying/pulling the head with the claw end of the hammer.



**Tie-Wire**

Size (in.)	Model No.	Drill Bit Diameter (in.)	Eyelet Hole Size (in.)	Quantity	
				Box	Carton
¼ x 1¼	TW25114	¼	¼	100	500

## Installation Sequence

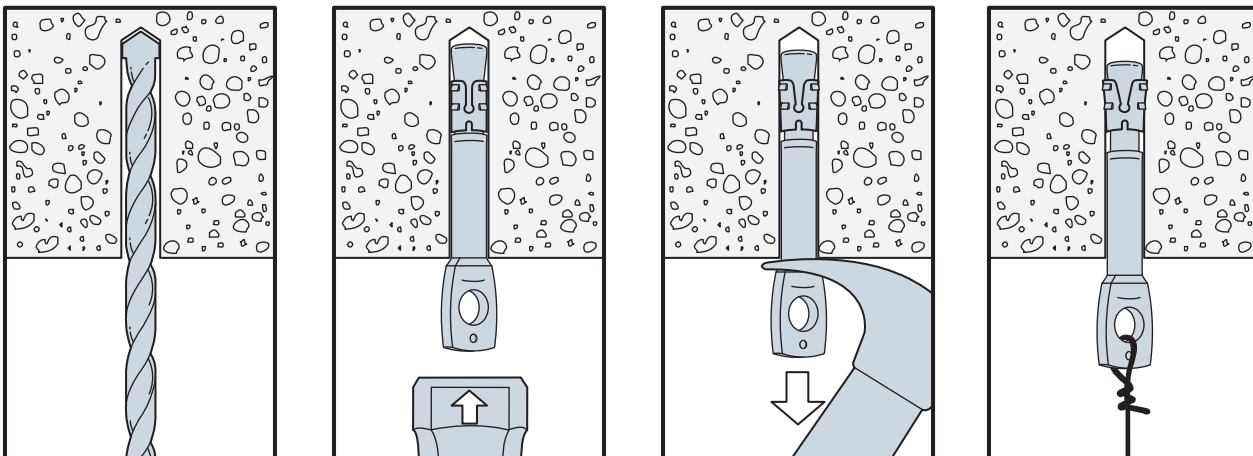

# Tie-Wire Wedge Anchor

Allowable Tension and Shear Loads for Tie-Wire Anchor in Normal-Weight Concrete

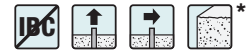

Size in. (mm)	Drill Bit Diameter in.	Embed Depth in. (mm)	Critical End Dist. in. (mm)	Critical Spacing in. (mm)	Tension Load		Shear Load	
					$f'_c \geq 2,500$ psi (17.2 MPa)		$f'_c \geq 2,500$ psi (17.2 MPa)	
					Ultimate lb. (kN)	Allowable lb. (kN)	Ultimate lb. (kN)	Allowable lb. (kN)
1/4 (6.4)	1/4	1 1/4 (32)	2 1/2 (64)	5 (127)	1,155 (5.1)	290 (1.3)	380 (1.7)	95 (0.4)

1. The allowable loads listed are based on a safety factor of 4.0.
2. The minimum concrete thickness is 1 1/2 times the embedment depth.

Allowable Tension and Shear Loads for Tie-Wire Anchor in the Soffit of Normal-Weight Concrete or Sand-Lightweight Concrete over Steel Deck



Size in. (mm)	Drill Bit Diameter in.	Embed Depth in. (mm)	Critical End Dist. <sup>5</sup> in. (mm)	Critical Spacing in. (mm)	Tension Load		Shear Load	
					$f'_c \geq 3,000$ psi (20.7 MPa)		$f'_c \geq 3,000$ psi (20.7 MPa)	
					Ultimate lb. (kN)	Allowable lb. (kN)	Ultimate lb. (kN)	Allowable lb. (kN)
1/4 (6.4)	1/4	1 1/4 (32)	2 1/2 (64)	5 (127)	1,155 (5.1)	290 (1.3)	460 (2.0)	115 (0.5)

1. The allowable loads listed are based on a safety factor of 4.0.
2. The minimum concrete thickness is 1 1/2 times the embedment depth.
3. Steel deck must be minimum 20-gauge thick with minimum yield strength of 33 ksi.
4. Anchors installed in the bottom flute of the steel deck must have a minimum edge distance of 1 1/2" away from inclined edge of the bottom flute. See the figure below.
5. Critical end distance is defined as the distance from the end of the slab in the direction of the flute.

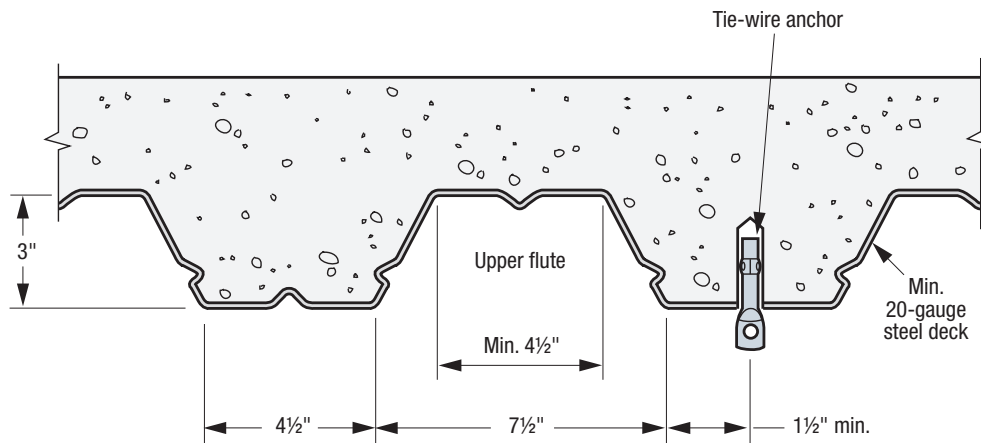

Installation in the Soffit of Concrete over Steel Deck

\* See p. 12 for an explanation of the load table icons.

# Titen Turbo™ Concrete and Masonry Screw Anchor

The Titen Turbo screw anchor features an innovative Torque Reduction Channel to trap drilling dust where it can't obstruct thread action, significantly reducing binding, stripping, and snapping without compromising strength. The patented reverse thread design enables smooth driving with less torque while providing superior holding power. The Torque Reduction Channel also allows more space for dust to help prevent anchors from bottoming out in smaller-diameter screw holes. The Titen Turbo screw anchors feature a serrated leading edge to cut into concrete or masonry, and a pointed tip for fast, easy installation in wood-to-concrete and wood-to-wood anchoring applications.

## Features

- Patent-pending Torque Reduction Channel that displaces dust where it can't obstruct the thread action, reducing the likelihood of binding in the hole
- Availability with either a hex head or, for a flush profile, a 6-lobe-drive countersunk flat head
- The 6-lobe drive's larger contact area provides better bit grip for reduced cam-outs, more torque, better performance and longer bit life
- 6-lobe bit included in packaging for countersunk flat head version
- Superior tension load performance compared to leading competitors in the market
- Matched-tolerance bit not required; use a standard ANSI drill bit for installation
- Serrated screw point for easier starts when fastening wood
- Designed for installation with an impact driver or cordless drill. Installation using the Titen Turbo Installation Tool is recommended.
- Use in dry interior environments only
- Code listed in accordance with ICC-ES AC193 for uncracked concrete and ICC-ES AC106 for masonry applications without cleaning dust from predrilled holes

**Codes:** IAPMO UES ER-712 (uncracked concrete) (City of LA Supplement within ER-712);

IAPMO UES ER-716 (masonry) (City of LA Supplement within ER-716); FL16230 (concrete and masonry)

**Material:** Carbon steel

**Coating:** Zinc plated with baked ceramic coating

## Installation Sequence

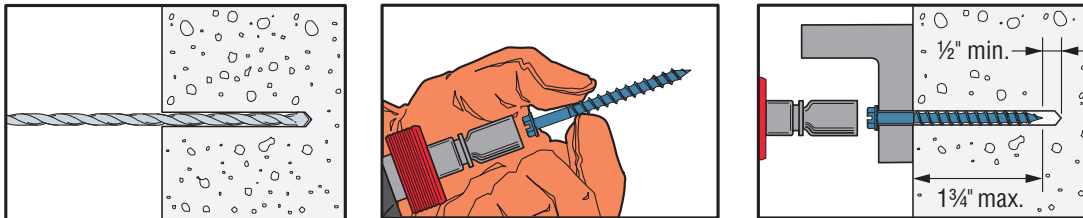

## Versatile Applications



Sliding door track installation



Window frames



Furring strips



**Titen Turbo Flat Head Screw**  
Patent Pending

**Titen Turbo Hex-Head Screw**  
Patent Pending

6-lobe drive



# Titen Turbo™ Concrete and Masonry Screw Anchor

Blue Titen Turbo Product Data (3/16" diameter)

Size (in.)	Head Style	Model No.	Drill Bit Dia. (in.)	Quantity	
				Pack	Carton
3/16 x 1 1/4	1/4" hex	TNT18114H	5/32	100	1,600
3/16 x 1 3/4		TNT18134H		100	500
3/16 x 2 1/4		TNT18214H		100	500
3/16 x 2 3/4		TNT18234H		100	500
3/16 x 3 1/4		TNT18314H		100	400
3/16 x 3 3/4		TNT18334H		100	400
3/16 x 1 1/4	T25 6-lobe flat	TNT18114TF	5/32	100	1,600
3/16 x 1 3/4		TNT18134TF		100	500
3/16 x 2 1/4		TNT18214TF		100	500
3/16 x 2 3/4		TNT18234TF		100	500
3/16 x 3 1/4		TNT18314TF		100	400
3/16 x 3 3/4		TNT18334TF		100	400

Blue Titen Turbo Product Data (1/4" diameter)

Size (in.)	Head Style	Model No.	Drill Bit Dia. (in.)	Quantity	
				Pack	Carton
1/4 x 1 1/4	5/16" hex	TNT25114H	3/16	100	1,600
1/4 x 1 3/4		TNT25134H		100	500
1/4 x 2 1/4		TNT25214H		100	500
1/4 x 2 3/4		TNT25234H		100	500
1/4 x 3 1/4		TNT25314H		100	400
1/4 x 3 3/4		TNT25334H		100	400
1/4 x 4		TNT25400H		100	400
1/4 x 5		TNT25500H		100	400
1/4 x 6		TNT25600H		100	400
1/4 x 1 1/4	T30 6-lobe flat	TNT25114TF	3/16	100	1,600
1/4 x 1 3/4		TNT25134TF		100	500
1/4 x 2 1/4		TNT25214TF		100	500
1/4 x 2 3/4		TNT25234TF		100	500
1/4 x 3 1/4		TNT25314TF		100	400
1/4 x 3 3/4		TNT25334TF		100	400
1/4 x 4	TNT25400TF	100	400		

White Titen Turbo Product Data (6-Lobe Flat Head)

Size (in.)	Head Style	Model No.	Drill Bit Dia. (in.)	Quantity	
				Pack	Carton
3/16 x 1 1/4	T25 6-lobe flat	TNTW18114TF	5/32	100	1,600
3/16 x 1 3/4		TNTW18134TF		100	500
3/16 x 2 1/4		TNTW18214TF		100	500
3/16 x 2 3/4		TNTW18234TF		100	500
3/16 x 3 1/4		TNTW18314TF		100	400
3/16 x 3 3/4		TNTW18334TF		100	400
1/4 x 1 1/4	T30 6-lobe flat	TNTW25114TF	3/16	100	1,600
1/4 x 1 3/4		TNTW25134TF		100	500
1/4 x 2 1/4		TNTW25214TF		100	500
1/4 x 2 3/4		TNTW25234TF		100	500
1/4 x 3 1/4		TNTW25314TF		100	400
1/4 x 3 3/4		TNTW25334TF		100	400

Silver Titen Turbo Product Data (6-Lobe Flat Head)

Size (in.)	Head Style	Model No.	Drill Bit Dia. (in.)	Quantity
3/16 x 1 3/4	T25 6-lobe flat	TNTS18134TFB	5/32	1,000
3/16 x 2 3/4		TNTS18234TFB		1,000
3/16 x 3 3/4		TNTS18334TFB		1,000
1/4 x 2 3/4	T30 6-lobe flat	TNTS25234TFB	3/16	1,000
1/4 x 3 1/4		TNTS25314TFB		1,000



Mechanical Anchors

# Titen Turbo™ Concrete and Masonry Screw Anchor

## Titen Turbo Screw Anchor — Installation Tool

Six-piece kit includes:

- 6-lobe bit socket
- T25 and T30 bits
- ¼" and ⅜" hex sockets
- Canvas storage bag



Titen Turbo Screw Anchor Installation Kit

### Titen Turbo Installation Tool

Model No.	Quantity	
	Clamshell	Carton
TNTINSTALLKIT	1	4

## Titen Turbo Screw Anchor — Drill Bits

Size (in.)	Model No.	Use With		Quantity	
		Screw	Length	Box	Carton
5/32 x 3 1/2	MDB15312	3/16" diameter	To 1 3/4	12	48
5/32 x 4 1/2	MDB15412		To 3 1/4		
5/32 x 5 1/2	MDB15512		To 4		
3/16 x 3 1/2	MDB18312	1/4" diameter	To 1 3/4	12	48
3/16 x 4 1/2	MDB18412		To 3 1/4		
3/16 x 5 1/2	MDB18512		To 4		



SDS-plus Shank Bit

## Titen Turbo Screw Anchor — SDS-plus® Drill Bits

Size (in.)	Model No.	For Screw Diameter (in.)	Drilling Depth (in.)	Overall Length (in.)
5/32 x 6	MDPL01506H	3/16	3 1/8	6
5/32 x 7	MDPL01507H		4 1/8	7
3/16 x 5	MDPL01805H	1/4	2 3/8	5
3/16 x 6	MDPL01806H		3 1/8	6
3/16 x 7	MDPL01807H		4 1/8	7

Titen drivers are sold individually.

## Titen Turbo Screw Drill Bit/Driver — Bulk Packs\*

Diameter (in.)	Drilling Depth (in.)	Overall Length (in.)	For Screw Diameter (in.)	Model No.
5/32	4 1/8	7	3/16	MDPL01507H-R25
3/16	4 1/8	7	1/4	MDPL01807H-R25

\*SDS-plus shank.

## Titen Turbo™ Concrete and Masonry Screw Anchor

Titen Turbo Installation Information and Additional Data<sup>1</sup>

Characteristic	Symbol	Units	Nominal Anchor Diameter (in.)	
			3/16	1/4
<b>Installation Information</b>				
Drill Bit Diameter	$d$	in.	5/32	3/16
Minimum Baseplate Clearance Hole Diameter	$d_c$	in.	1/4	5/16
Minimum Hole Depth	$h_{hole}$	in.	2 1/4	2 1/4
Embedment Depth	$h_{nom}$	in.	1 3/4	1 3/4
Effective Embedment Depth	$h_{ef}$	in.	1.25	1.20
Critical Edge Distance	$c_{ac}$	in.	3	3
Minimum Edge Distance	$c_{min}$	in.	1 3/4	1 3/4
Minimum Spacing	$s_{min}$	in.	1	2
Minimum Concrete Thickness	$h_{min}$	in.	3 1/4	3 1/4
<b>Additional Data</b>				
Yield Strength	$f_{ya}$	psi	100,000	
Tensile Strength	$f_{uta}$	psi	125,000	
Minimum Tensile and Shear Stress Area	$A_{se}$	in. <sup>2</sup>	0.0131	0.0211

1. The information presented in this table is to be used in conjunction with the design criteria of ACI 318-14 Chapter 17 or ACI 318-11 Appendix D.

Titen Turbo Tension Strength Design Data<sup>1</sup>

Characteristic	Symbol	Units	Nominal Anchor Diameter (in.)	
			3/16	1/4
Anchor Category	1, 2 or 3	—	1	
Embedment Depth	$h_{nom}$	in.	1 3/4	1 3/4
<b>Steel Strength in Tension</b>				
Tension Resistance of Steel	$N_{sa}$	lb.	1,640	2,640
Strength Reduction Factor — Steel Failure	$\phi_{sa}$	—	0.65 <sup>2</sup>	
<b>Concrete Breakout Strength in Tension</b>				
Effective Embedment Depth	$h_{ef}$	in.	1.25	1.20
Critical Edge Distance	$c_{ac}$	in.	3	3
Effectiveness Factor — Uncracked Concrete	$k_{uncr}$	—	24	
Modification Factor	$\Psi_{c,N}$	—	1.0	
Strength Reduction Factor — Concrete Breakout Failure	$\phi_{cb}$	—	0.65 <sup>3</sup>	
<b>Pullout Strength in Tension</b>				
Pullout Resistance Uncracked Concrete ( $f'_c = 2,500$ psi) <sup>4</sup>	$N_{p,uncr}$	lb.	1,515	1,515
Strength Reduction Factor — Pullout Failure	$\phi_p$	—	0.65 <sup>5</sup>	

- The information presented in this table is to be used in conjunction with the design criteria of ACI 318-14 Chapter 17 or ACI 318-11 Appendix D.
- The tabulated value of  $\phi_{sa}$  applies when the load combinations of Section 1605.2 of the IBC, ACI 318-14 Section 5.3 or ACI 318-11 Section 9.2 are used. If the load combinations of ACI 318-11 Appendix C are used, the appropriate value of  $\phi$  must be determined in accordance with ACI 318-11 Section D.4.4.
- The tabulated value of  $\phi_{cb}$  applies when both the load combinations of Section 1605.2 of the IBC, ACI 318-14 Section 5.3 or ACI 318-11 Section 9.2 are used and the requirements of ACI 318-14 Section 17.3.3 (c) or ACI 318-11 Section D.4.3, as applicable, for Condition B are met. Condition B applies when supplementary reinforcement is not provided. For installations where complying supplementary reinforcement can be verified, the  $\phi_{cb}$  factor described in ACI 318-14 Section 17.3.3 (c) or ACI 318-11 Section D.4.3, as applicable, for Condition A are allowed. If the load combinations of ACI 318-11 Appendix C are used, the appropriate value of  $\phi$  must be determined in accordance with ACI 318-11 Section D.4.4.
- The characteristic pullout resistance for greater compressive strengths may be increased by multiplying the tabular value by  $(f'_c/2500)^{0.23}$  for 1/4" screw anchors. No increase in the characteristic pullout resistance for greater compressive strengths is permitted for 3/16" screw anchors.
- The tabulated value of  $\phi_p$  applies when both the load combinations of Section 1605.2 of the IBC, ACI 318-14 Section 5.3 or ACI 318-11 Section 9.2 are used and the requirements of ACI 318-14 Section 17.3.3 (c) or ACI 318-11 Section D.4.3 (c) for Condition B are met. If the load combinations of ACI 318-11 Appendix C are used, the appropriate value of  $\phi$  must be determined in accordance with ACI 318-11 Section D.4.4 for Condition B.

\* See p. 12 for an explanation of the load table icons.

# Titen Turbo™ Concrete and Masonry Screw Anchor

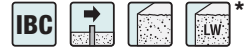

## Titen Turbo Shear Strength Design Data Into Concrete<sup>1</sup>

Characteristic	Symbol	Units	Nominal Anchor Diameter (in.)	
			3/16	1/4
Anchor Category	1, 2 or 3	—	1	
Embedment Depth	$h_{nom}$	in.	1 3/4	1 3/4
<b>Steel Strength in Shear</b>				
Shear Resistance of Steel	$V_{sa}$	lb.	475	720
Strength Reduction Factor — Steel Failure	$\phi_{sa}$	—	0.60 <sup>2</sup>	
<b>Concrete Breakout Strength in Shear</b>				
Outside Diameter	$d_a$	in.	0.129	0.164
Load Bearing Length of Anchor in Shear	$l_e$	in.	1.25	1.20
Strength Reduction Factor — Concrete Breakout Failure	$\phi_{cb}$	—	0.70 <sup>3</sup>	
<b>Concrete Pryout Strength in Shear</b>				
Coefficient for Pryout Strength	$k_{cp}$	—	1.0	
Strength Reduction Factor — Concrete Pryout Failure	$\phi_{cp}$	—	0.70 <sup>4</sup>	

- The information presented in this table is to be used in conjunction with the design criteria of ACI 318-14 Chapter 17 or ACI 318-11 Appendix D.
- The tabulated value of  $\phi_{sa}$  applies when the load combinations of Section 1605.2 of the IBC, ACI 318-14 Section 5.3 or ACI 318-11 Section 9.2 are used. If the load combinations of ACI 318-11 Appendix C are used, the appropriate value of  $\phi$  must be determined in accordance with ACI 318-11 Section D.4.4.
- The tabulated value of  $\phi_{cb}$  applies when both the load combinations of Section 1605.2 of the IBC, ACI 318-14 Section 5.3 or ACI 318-11 Section 9.2 are used and the requirements of ACI 318-14 Section 17.3.3 (c) or ACI 318-11 Section D.4.3, as applicable, for Condition B are met. Condition B applies when supplementary reinforcement is not provided. For installations where complying supplementary reinforcement can be verified, the  $\phi_{cb}$  factor described in ACI 318-14 Section 17.3.3 (c) or ACI 318-11 Section D.4.3, as applicable, for Condition A are allowed. If the load combinations of ACI 318-11 Appendix C are used, the appropriate value of  $\phi$  must be determined in accordance with ACI 318-11 Section D.4.4.
- The tabulated value of  $\phi_{cp}$  applies when both the load combinations of Section 1605.2 of the IBC, ACI 318-14 Section 5.3 or ACI 318-11 Section 9.2 are used and the requirements of ACI 318-14 Section 17.3.3 (c) or ACI 318-11 Section D.4.3 (c) for Condition B are met. If the load combinations of ACI 318-11 Appendix C are used, the appropriate value of  $\phi$  must be determined in accordance with ACI 318-11 Section D.4.4 (c).

**Torque Reduction Channel to trap drilling dust where it can't obstruct thread action.**

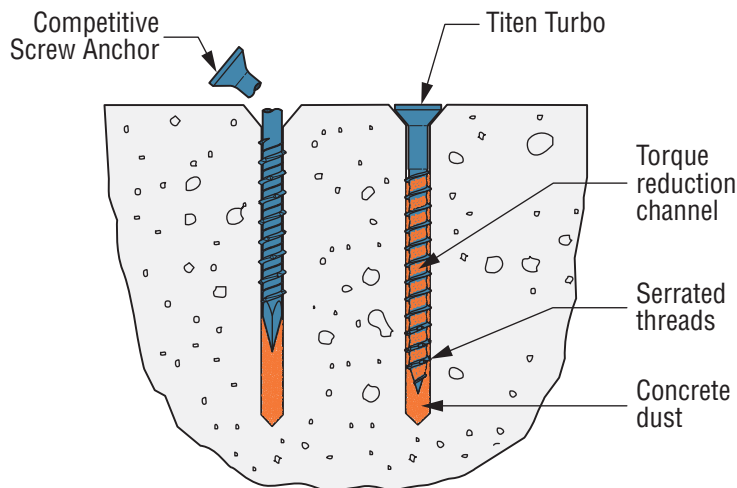

**Torque Reduction Channel  
Displaces Dust for Trouble-Free Installation**  
US Patent Pending

\* See p. 12 for an explanation of the load table icons.

# Titen Turbo™ Concrete and Masonry Screw Anchor

Allowable Tension Load for Titen Turbo™ Screw Anchor  
Installed in Face of Grouted CMU<sup>1,2,3</sup>



Anchor Diameter (in.)	Embedment Depth (in.)	Minimum Dimensions (in.)			Allowable Load (lb.) <sup>4</sup>
		Spacing	Edge	End	
3/16	2	3	3 7/8	3 7/8	267
3/16	2	3	1 1/2	3 7/8	267
1/4	2	4	3 7/8	3 7/8	393
1/4	2	4	1 1/2	3 7/8	343

1. The tabulates values are for screw anchors installed in minimum 8"-wide grouted concrete masonry walls having reached a minimum  $f'_m$  of 1,500 psi at time of installation.
2. Embedment is measured from the masonry surface to the embedded end of the screw anchor.
3. Screw anchors must be installed in grouted cell. The minimum edge and end distances must be maintained.
4. Allowable loads are based on a safety factor of 5.0 for installations under the IBC and IRC.

Allowable Shear Load for Titen Turbo Screw Anchor  
Installed in Face of Grouted CMU<sup>1,2,3</sup>



Anchor Diameter (in.)	Embedment Depth (in.)	Minimum Dimensions (in.)			Direction of Loading	Allowable Load (lb.) <sup>4</sup>
		Spacing	Edge	End		
3/16	2	3	3 7/8	3 7/8	Toward edge, parallel to wall end	218
3/16	2	3	1 1/2	3 7/8	Toward wall end, parallel to wall edge	218
1/4	2	4	3 7/8	3 7/8	Toward edge, parallel to wall end	342
1/4	2	4	1 1/2	3 7/8	Toward wall end, parallel to wall edge	283

1. The tabulates values are for screw anchors installed in minimum 8"-wide grouted concrete masonry walls having reached a minimum  $f'_m$  of 1,500 psi at time of installation.
2. Embedment is measured from the masonry surface to the embedded end of the screw anchor.
3. Screw anchors must be installed in grouted cell. The minimum edge and end distances must be maintained.
4. Allowable loads are based on a safety factor of 5.0 for installations under the IBC and IRC.

Allowable Tension Load for Titen Turbo Screw Anchor  
Installed in Hollow CMU Wall Faces<sup>1,2,3</sup>



Anchor Diameter (in.)	Embedment Depth (in.)	Minimum Dimensions (in.)			Allowable Load (lb.) <sup>4</sup>
		Spacing	Edge	End	
3/16	1 1/4	3	3 7/8	3 7/8	117
1/4	1 1/4	4	3 7/8	3 7/8	117

1. The tabulates values are for screw anchors installed in minimum 8"-wide grouted concrete masonry walls having reached a minimum  $f'_m$  of 1,500 psi at time of installation.
2. Embedment is the thickness of the face shell.
3. Screw anchors may be installed at any location in the wall face provided the minimum edge and end distances are maintained.
4. Allowable loads are based on a safety factor of 5.0 for installations under the IBC and IRC.

Allowable Shear Load for Titen Turbo Screw Anchor  
Installed in Hollow CMU Wall Faces<sup>1,2,3</sup>



Anchor Diameter (in.)	Embedment Depth (in.)	Minimum Dimensions (in.)			Direction of Loading	Allowable Load (lb.) <sup>4</sup>
		Spacing	Edge	End		
3/16	1 1/4	3	3 7/8	3 7/8	Toward edge, parallel to wall end	164
1/4	1 1/4	4	3 7/8	3 7/8	Toward edge, parallel to wall end	190

1. The tabulates values are for screw anchors installed in minimum 8"-wide grouted concrete masonry walls having reached a minimum  $f'_m$  of 1,500 psi at time of installation.
2. Embedment is the thickness of the face shell.
3. Screw anchors may be installed at any location in the wall face provided the minimum edge and end distances are maintained.
4. Allowable loads are based on a safety factor of 5.0 for installations under the IBC and IRC.

\* See p. 12 for an explanation of the load table icons.

# Titen® Stainless Steel Concrete and Masonry Screw

Stainless steel Titen screws are ideal for attaching various types of components to concrete and masonry, such as fastening electrical boxes or light fixtures. They offer the versatility of our standard Titen screws with enhanced corrosion protection. Available in hex and Phillips flat head. Available in lengths from 1 ¼"-4".

## Features

- Suitable for concrete, brick, grout-filled CMU and hollow-block applications
- Suitable for some preservative-treated wood applications
- Acceptable for exterior use
- Titen drill bits included in each box
- Available in lengths from 1 ¼"-4"
- Installation using the Titen Installation Kit is recommended

**Codes:** FL2355

**Material:** Type 410 stainless steel

**Coating:** Zinc plated with a protective overcoat

## Installation

**Caution:** Industry studies show that hardened fasteners can experience performance problems in wet or corrosive environments. Steps must be taken to prevent inadvertent sustained loads above the listed allowable loads. Overtightening and bending moments can initiate cracks detrimental to the hardened screw's performance. Use the Simpson Strong-Tie Titen installation tool kit as it has a bit that is designed to reduce the potential for overtightening the screw.

**Caution:** Oversized holes in the base material will reduce or eliminate the mechanical interlock of the threads with the base material and will reduce the anchor's load capacity.

1. Drill a hole in the base material using the appropriate diameter carbide drill bit as specified in the table. Drill the hole to the specified embedment depth plus ½" to allow the thread tapping dust to settle and blow it clean using compressed air. Overhead installations need not be blown clean. Alternatively, drill the hole deep enough to accommodate embedment depth and dust from drilling and tapping.
2. Position fixture, insert screw and tighten using drill and Titen screw installation tool fitted with a hex socket or phillips bit.

Preservative-treated wood applications: suitable for use in non-ammonia formulations of CCA, ACQ-C, ACQ-D, CA-B, SBX/DOT and zinc borate. Acceptable for use in exterior environments. Use caution not to damage coating during installation. The 410 stainless-steel Titen with top coat provides "medium" corrosion protection. Recommendations are based on testing and experience at time of publication and may change. Simpson Strong-Tie cannot provide estimates on service life of screws.



**Titen**  
**Stainless-Steel**  
**Phillips Flat Head Screw**  
**(PFSS)**



**Titen**  
**Stainless-Steel**  
**Hex-Head Screw**  
**(HSS)**

## Stainless-Steel Titen Product Data

Size (in.)	Head Style	Model No.	Drill Bit Diameter (in.)	Quantity	
				Box	Carton
¼ x 1 ¼	Hex-Head	TTN25114HSS	⅜	100	1600
¼ x 1 ¾		TTN25134HSS		100	500
¼ x 2 ¼		TTN25214HSS		100	500
¼ x 2 ¾		TTN25234HSS		100	500
¼ x 3 ¼		TTN25314HSS		100	400
¼ x 3 ¾		TTN25334HSS		100	400
¼ x 4		TTN25400HSS		100	400
¼ x 1 ¼	Phillips Flat-Head	TTN25114PFSS	⅜	100	1600
¼ x 1 ¾		TTN25134PFSS		100	500
¼ x 2 ¼		TTN25214PFSS		100	500
¼ x 2 ¾		TTN25234PFSS		100	500
¼ x 3 ¼		TTN25314PFSS		100	400
¼ x 3 ¾		TTN25334PFSS		100	400
¼ x 4		TTN25400PFSS		100	400

One drill bit is included in each box.

## Installation Sequence

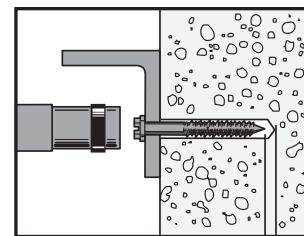
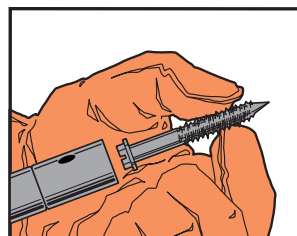
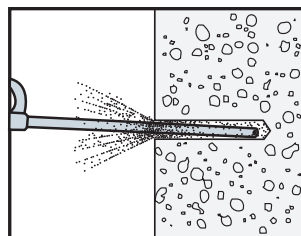
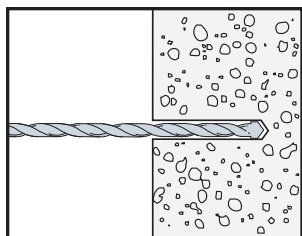

1 ½" max. ← → ½" min.

## Titen® Stainless Steel Concrete and Masonry Screw

## Stainless-Steel Titen Allowable Tension and Shear Loads in Normal-Weight Concrete

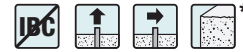

Dia. in. (mm)	Drill Bit Dia. in.	Embed. Depth in. (mm)	Critical Spacing in. (mm)	Critical Edge Dist. in. (mm)	Tension Load				Shear Load	
					$f'_c \geq 2,000$ psi (13.8 MPa) Concrete		$f'_c \geq 4,000$ psi (27.6 MPa) Concrete		$f'_c \geq 2,000$ psi (13.8 MPa) Concrete	
					Ultimate lb. (kN)	Allow. lb. (kN)	Ultimate lb. (kN)	Allow. lb. (kN)	Ultimate lb. (kN)	Allow. lb. (kN)
1/4 (6.4)	3/16	1 (25.4)	3 (76.2)	1 1/2 (38.1)	600 (2.7)	150 (0.7)	935 (4.2)	235 (1.0)	760 (3.4)	190 (0.8)
1/4 (6.4)	3/16	1 1/2 (38.1)	3 (76.2)	1 1/2 (38.1)	1,040 (4.6)	260 (1.2)	1,760 (7.8)	440 (2.0)	810 (3.6)	200 (0.9)

1. Maximum anchor embedment is 1 1/2" (38.1 mm).
2. Minimum concrete thickness is 1.5 x embedment.

## Stainless-Steel Titen Allowable Tension and Shear Loads in Face Shell of Hollow and Grout-Filled CMU

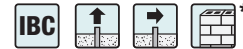

Dia. in. (mm)	Drill Bit Dia. in.	Embed. Depth in. (mm)	Critical Spacing in. (mm)	Critical Edge Dist. in. (mm)	Values for 6" or 8" Lightweight, Medium-Weight or Normal-Weight CMU			
					Tension Load		Shear Load	
					Ultimate lb. (kN)	Allow. lb. (kN)	Ultimate lb. (kN)	Allow. lb. (kN)
1/4 (6.4)	3/16	1 (25.4)	4 (101.6)	1 1/2 (38.1)	550 (2.4)	110 (0.5)	495 (2.2)	100 (0.4)

1. The tabulated allowable loads are based on a safety factor of 5.0.
2. Maximum anchor embedment is 1 1/2" (38.1 mm).

## Length Identification Head Marks on Stainless-Steel Titen Screw Anchors (corresponds to anchor length in inches)

Length ID Marking on Head		—	A	B	C	D	E	F	G	H	I	J
Length of Anchor (in.)	From	1	1 1/2	2	2 1/2	3	3 1/2	4	4 1/2	5	5 1/2	6
	Up To But Not Including	1 1/2	2	2 1/2	3	3 1/2	4	4 1/2	5	5 1/2	6	6 1/2

For SI: 1 inch = 25.4 mm.

# Titen HD® Threaded Rod Hanger

The Titen HD threaded rod hanger is a high-strength screw anchor designed to suspend threaded rod from concrete slabs, beams or concrete over steel in order to hang pipes, cable trays and other HVAC equipment. The anchor offers low installation torque with no secondary setting, and has been tested to offer industry-leading performance in cracked and uncracked concrete — even in seismic loading conditions.

## Features

- Thread design undercuts to efficiently transfer the load to the base material
- Serrated cutting teeth and patented thread design enable quick and easy installation
- Specialized heat-treating process creates tip hardness to facilitate cutting while the anchor body remains ductile
- Designed to install using a rotary hammer or hammer drill with standard ANSI drill bits — no special tools required
- Installs with standard-sized sockets
- Code listed for cracked and uncracked concrete applications under the 2015, 2012 and 2009 IBC/IRC, per ICC-ES ESR-2713
- FM listed

**Codes:** ICC-ES ESR-2713;

City of LA Supplement within ESR-2713;

FL15730;

Factory Mutual 3031136 (THD50234RH)  
and 3061897 (THDB37158RH)

**Material:** Carbon steel

**Coating:** Zinc plated

## Installation

- Caution:** Oversized holes in the base material will reduce or eliminate the mechanical interlock of the threads with base material and will reduce the anchor's load capacity.
- Caution:** Use a Titen HD® rod hanger one time only. Installing the anchor multiple times may result in excessive thread wear and reduce load capacity.

1. Drill a hole using the specified diameter carbide bit into the base material to the specified embedment depth plus minimum hole depth overdrill (see the product data table on the next page).
2. Blow the hole clean of dust and debris using compressed air.
3. Install with a torque wrench, driver drill, hammer drill or cordless impact wrench.
4. Fully insert threaded rod.

## Installation Sequence

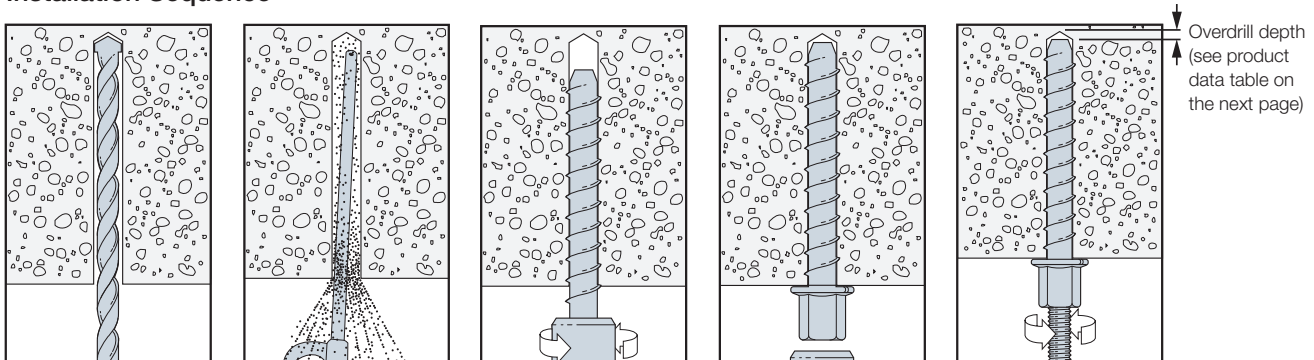





U.S. Patent 6,623,228



## Titen HD® Rod Hanger Design Information — Concrete

Titen HD Threaded Rod Hanger Product Data

	Size (in.)	Model No.	Accepts Rod Dia. (in.)	Drill Bit Dia. (in.)	Wrench Size (in.)	Min. Embed. (in.)	Hole Depth Overdrill (in.)	Quantity	
								Box	Carton
	¼ x 1½	THDB25158RH	¼	¼	¾	1½	½	100	500
 	¾ x 1½	THDB37158RH	¾	¼	½	1½	½	50	200
 	½ x 2¾	THD50234RH	½	¾	1½	2½	¼	50	100

Titen HD Threaded Rod Hanger Installation Information and Additional Data<sup>1</sup>

Characteristic	Symbol	Units	Model No.	
			THDB25158RH THDB37158RH	THD50234RH
<b>Installation Information</b>				
Rod Hanger Diameter	$d_o$	in.	¼ or ¾	½
Drill Bit Diameter	$d_{bit}$	in.	¼	¾
Maximum Installation Torque <sup>2</sup>	$T_{inst,max}$	ft.-lb.	24	50
Maximum Impact Wrench Torque Rating <sup>3</sup>	$T_{impact,max}$	ft.-lb.	125	150
Minimum Hole Depth	$h_{hole}$	in.	1¾	3
Embedment Depth	$h_{nom}$	in.	1½	2¾
Effective Embedment Depth	$h_{ef}$	in.	1.19	1.77
Critical Edge Distance	$c_{ac}$	in.	3	2½
Minimum Edge Distance	$c_{min}$	in.	1½	1¾
Minimum Spacing	$s_{min}$	in.	1½	3
Minimum Concrete Thickness	$h_{min}$	in.	3¼	4¼
<b>Anchor Data</b>				
Yield Strength	$f_{ya}$	psi	100,000	97,000
Tensile Strength	$f_{uta}$	psi	125,000	110,000
Minimum Tensile and Shear Stress Area	$A_{se}$	in. <sup>2</sup>	0.042	0.099
Axial Stiffness in Service Load Range — Uncracked Concrete	$\beta_{uncr}$	lb./in.	202,000	672,000
Axial Stiffness in Service Load Range — Cracked Concrete	$\beta_{cr}$	lb./in.	173,000	345,000

1. The information presented in this table is to be used in conjunction with the design criteria of ACI 318-14 Chapter 17 or ACI 318-11 Appendix D.

2.  $T_{inst,max}$  is the maximum permitted installation torque for installations using a torque wrench.

3.  $T_{impact,max}$  is the maximum permitted torque rating for impact wrenches.

## Titen HD® Rod Hanger Design Information — Concrete

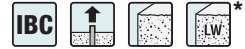
Titen HD Threaded Rod Hanger Tension Strength Design Data for Installations in Concrete<sup>1</sup>

Characteristic	Symbol	Units	Model No.	
			THDB25158RH THDB37158RH	THD50234RH
Anchor Category	1, 2 or 3	—	1	
Embedment Depth	$h_{nom}$	in.	1½	2½
<b>Steel Strength in Tension (ACI 318-14 Section 17.4.1 or ACI 318-11 Section D.5.1)</b>				
Tension Resistance of Steel	$N_{sa}$	lb.	5,195	10,890
Strength Reduction Factor — Steel Failure <sup>2</sup>	$\phi_{sa}$	—	0.65	
<b>Concrete Breakout Strength in Tension (ACI 318-14 Section 17.4.2 or ACI 318-11 Section D.5.2)</b>				
Effective Embedment Depth	$h_{ef}$	in.	1.19	1.77
Critical Edge Distance	$c_{ac}$	in.	3	2 <sup>11</sup> / <sub>16</sub>
Effectiveness Factor — Uncracked Concrete	$k_{uncr}$	—	30	24
Effectiveness Factor — Cracked Concrete	$k_{cr}$	—	17	
Modification Factor	$\psi_{c,N}$	—	1.0	
Strength Reduction Factor — Concrete Breakout Failure <sup>3</sup>	$\phi_{cb}$	—	0.65	
<b>Pullout Strength in Tension (ACI 318-14 Section 17.4.3 or ACI 318-11 Section D.5.3)</b>				
Pullout Resistance — Uncracked Concrete ( $f'_c = 2,500$ psi)	$N_{p,uncr}$	lb.	N/A <sup>4</sup>	2,025 <sup>5</sup>
Pullout Resistance — Cracked Concrete ( $f'_c = 2,500$ psi)	$N_{p,cr}$	lb.	N/A <sup>4</sup>	1,235 <sup>5</sup>
Strength Reduction Factor — Pullout Failure <sup>6</sup>	$\phi_p$	—	0.65	
<b>Tension Strength for Seismic Applications (ACI 318-14 Section 17.2.3.3 or ACI 318-11 Section D.3.3.3)</b>				
Nominal Pullout Strength for Seismic Loads ( $f'_c = 2,500$ psi)	$N_{p,eq}$	lb.	N/A <sup>4</sup>	1,235 <sup>5</sup>
Strength Reduction Factor — Pullout Failure <sup>6</sup>	$\phi_{eq}$	—	0.65	

- The information presented in this table is to be used in conjunction with the design criteria of ACI 318-14 Chapter 17 or ACI 318-11 Appendix D, as applicable.
- The tabulated value of  $\phi_{sa}$  applies when the load combinations of Section 1605.2 of the IBC, ACI 318-14 Section 5.3 or ACI 318-11 Section 9.2 are used, as applicable. If the load combinations of ACI 318-11 Appendix C are used, the appropriate value of  $\phi$  must be determined in accordance with ACI 318-11 D.4.4(b), as applicable.
- The tabulated values of  $\phi_{cb}$  applies when both the load combinations of Section 1605.2 of the IBC, ACI 318-14 Section 5.3 or ACI 318-11 Section 9.2, as applicable, are used and the requirements of ACI 318-11 D.4.3(c) for Condition B are met. Condition B applies where supplementary reinforcement is not provided in concrete. For installations where complying reinforcement can be verified, the  $\phi_{cb}$  factors described in ACI 318-14 17.3.3(c) or ACI 318-11 D.4.3(c), as applicable, may be used for Condition A. If the load combinations of ACI 318-11 Appendix C are used, the appropriate value of  $\phi$  must be determined in accordance with ACI 318-11 D.4.4(c) for Condition B.
- As described in this report, N/A denotes that pullout resistance does not govern and does not need to be considered.
- The characteristic pullout resistance for greater compressive strengths may be increased by multiplying the tabular value by  $(f'_c/2,500)^{0.5}$ .
- The tabulated values of  $\phi_p$  or  $\phi_{eq}$  applies when both the load combinations of ACI 318-14 Section 5.3 or ACI 318-11 Section 9w.2, as applicable, are used and the requirements of ACI 318-14 17.3.3(c) or ACI 318-11 D.4.3(c) for Condition B are met. Condition B applies where supplementary reinforcement is not provided in concrete. For installations where complying reinforcement can be verified, the  $\phi_p$  or  $\phi_{eq}$  factors described in ACI 318-14 17.3.3(c) or ACI 318-11 D.4.3(c), as applicable, may be used for Condition A. If the load combinations of ACI 318-11 Appendix C are used, the appropriate value of  $\phi$  must be determined in accordance with ACI 318-11 D.4.4(c) for Condition B.

\* See p. 12 for an explanation of the load table icons.

# Titen HD® Rod Hanger Design Information — Concrete

Titen HD Threaded Rod Hanger Tension Strength Design Data for Installations in the Lower and Upper Flute of Normal-Weight or Sand-Lightweight Concrete Through Steel Deck<sup>1,2,5,6</sup>



Characteristic	Symbol	Units	Model No.		
			Lower Flute		Upper Flute
			Figure 2	Figure 1	Figure 2
			THDB25158RH THDB37158RH	THD50234RH	THDB25158RH THDB37158RH
Minimum Hole Depth	$h_{hole}$	in.	1¾	3	1¾
Embedment Depth	$h_{nom}$	in.	1⅝	2½	1⅝
Effective Embedment Depth	$h_{ef}$	in.	1.19	1.77	1.19
Pullout Resistance – Cracked Concrete <sup>2,3,4</sup>	$N_{p,deck,cr}$	lbf.	420	870	655
Pullout Resistance – Uncracked Concrete <sup>2,3,4</sup>	$N_{p,deck,uncr}$	lbf.	995	1,430	1,555

- The information presented in this table is to be used in conjunction with the design criteria of ACI 318-14 Chapter 17 or ACI 318-11 Appendix D, as applicable.
- Concrete compressive strength shall be 3,000 psi minimum. The characteristic pullout resistance for greater compressive strengths shall be increased by multiplying the tabular value by  $(f'_{c,specified}/3,000 \text{ psi})^{0.5}$ .
- For anchors installed in the soffit of sand-lightweight or normal-weight concrete over steel deck floor and roof assemblies, as shown in Figure 1 or Figure 2, calculation of the concrete breakout strength may be omitted.
- In accordance with ACI 318-14 Section 17.4.3.2 or ACI 318-11 Section D.5.3.2, the nominal pullout strength in cracked concrete for anchors installed in the soffit of sand-lightweight or normal-weight-concrete-over-steel-deck floor and roof assemblies  $N_{p,deck,cr}$  shall be substituted for  $N_{p,cr}$ . Where analysis indicates no cracking at service loads, the normal pullout strength in uncracked concrete  $N_{p,deck,uncr}$  shall be substituted for  $N_{p,uncr}$ .
- Minimum distance to edge of panel is  $2h_{ef}$ .
- The minimum anchor spacing along the flute must be the greater of  $3h_{ef}$  or 1.5 times the flute width.

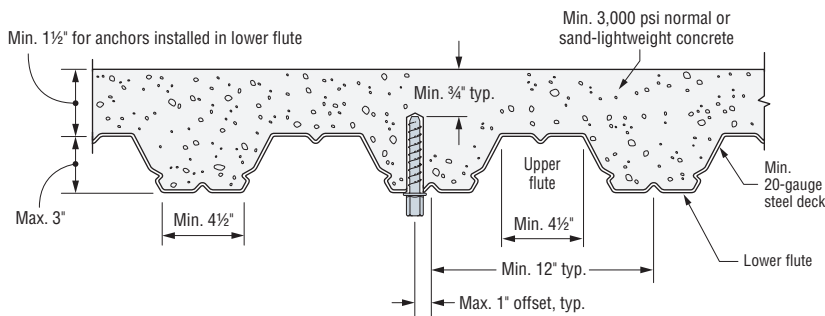

Figure 1. THD50234RH Installation in Concrete over Steel Deck

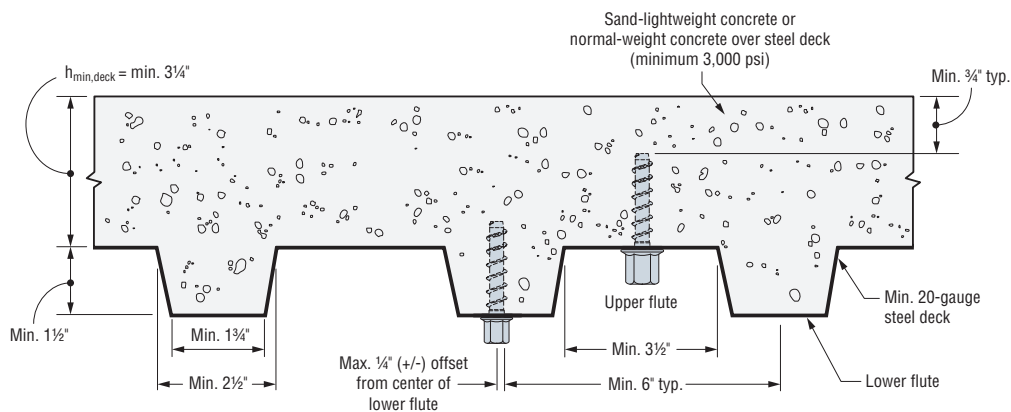

Figure 2. THDB25158RH and THDB37158RH Installation in Concrete over Steel Deck

\* See p. 12 for an explanation of the load table icons.

# Steel Rod Hanger Threaded Rod Anchor System

The Simpson Strong-Tie® steel rod hanger is a one-piece fastening system for suspending 1/4" and 3/8" threaded rod. Vertical rod hangers are designed to suspend threaded rod in overhead applications from steel joists and beams. Horizontal rod hangers are available for applications requiring installation into the side of joists, columns and overhead members. Both rod hangers provide attachment points for use in pipe hanging, fire protection, electrical conduit and cable-tray applications. Recommended for use in dry, interior, non-corrosive environments only.

## Features

- Threaded anchors for rod-hanging applications in steel members
- Suitable to be installed horizontally or vertically in overhead applications
- Self-drilling tip, no predrilling required
- Recommend installation with a 18V cordless drill/driver
- Custom-matched nut driver sets anchor to optimal depth

**Codes:** FM 3058980;  
UL File Ex3605

**Material:** Carbon steel

**Coating:** Zinc plated

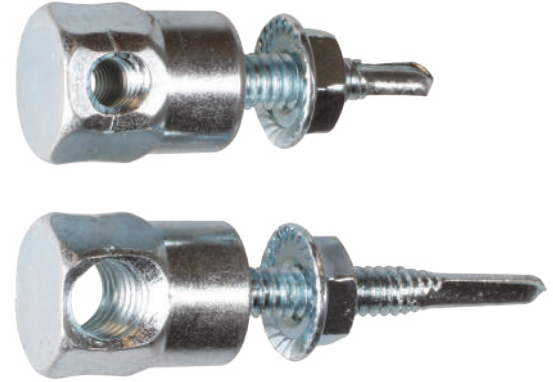

**RSH**  
**Horizontal Steel**  
**Rod Hangers**

## Steel Rod Hangers

Rod Diameter (in.)	Size	Model No.	Drill Point	Application	Steel Thickness Range	Quantity	
						Box	Carton
1/4	1/4" x 1" with nut	RSH25100N	#3	Horizontal	20 ga. – 12 ga.	25	250
1/4	#12–20 x 1 1/2"	RSH25112-5	#5		20 ga. – 1/4"		
3/8	1/4" x 1" with nut	RSH37100N	#3		20 ga. – 12 ga.		
3/8	#12–20 x 1 1/2"	RSH37112N-5	#5		20 ga. – 1/4"		
1/4	1/4" x 1"	RSV25100	#3	Vertical	20 ga. – 12 ga.	25	250
3/8	1/4" x 1" with nut	RSV37100N	#3		20 ga. – 12 ga.		
3/8	1/4" x 1 1/2"	RSV37112	#3		20 ga. – 14 ga.		
3/8	1/4" x 1 1/2" with nut	RSV37112N	#3		20 ga. – 14 ga.		
3/8	#12–20 x 1 1/2"	RSV37112N-5	#5		20 ga. – 1/4"		
3/8	1/4" x 2"	RSV37200	#3		20 ga. – 14 ga.		



**RSV**  
**Vertical Steel**  
**Rod Hangers**

## Nut Driver

Custom-matched nut driver sets the rod hangers to optimal depth every time.

Model No.	Description	Quantity	
		Box	Carton
RND62	Nut driver	10	60



**RND62**

# Steel Rod Hanger Threaded Rod Anchor System



## Ultimate and Allowable Loads for Vertical Steel Rod Hangers

Model No.	Rod Dia. (in.)	Size (in.)	Loads in Various Steel Thicknesses												UL Listed Steel Thickness Range	FM Listed Steel Thickness Range		
			33 mil (20 ga.)		43 mil (18 ga.)		54 mil (16 ga.)		68 mil (14 ga.)		97 mil (12 ga.)		3/16"				1/4"	
			Ult. (lb.)	Allow. (lb.)	Ult. (lb.)	Allow. (lb.)	Ult. (lb.)	Allow. (lb.)	Ult. (lb.)	Allow. (lb.)	Ult. (lb.)	Allow. (lb.)	Ult. (lb.)	Allow. (lb.)			Ult. (lb.)	Allow. (lb.)
RSV25100	1/4	1/4 x 1	355	130	575	190	880	325	1,110	410	2,050	760	—	—	—	—	—	—
RSV37100N <sup>3</sup>	3/8	1/4 x 1	1,370	505	1,980	730	3,405	1,260	3,890	1,440	3,900	1,440	—	—	—	—	20 ga. – 12 ga.	16 ga. – 12 ga.
RSV37112	3/8	1/4 x 1 1/2	355	130	575	190	880	325	1,110	410	—	—	—	—	—	—	—	—
RSV37112N <sup>3</sup>	3/8	1/4 x 1 1/2	1,370	505	1,980	730	3,405	1,260	3,890	1,440	—	—	—	—	—	—	20 ga. – 14 ga.	16 ga. – 14 ga.
RSV37200	3/8	1/4 x 2	355	130	575	190	880	325	1,110	410	—	—	—	—	—	—	—	—
RSV37112N-5 <sup>3</sup>	3/8	#12–20 x 1 1/2	1,370	505	1,980	730	2,185	730	2,185	730	2,560	940	3,290	1,095	3,290	1,095	20 ga. – 1/4"	16 ga. – 1/4"

Footnotes below apply to both tables.



## Ultimate and Allowable Loads for Horizontal Steel Rod Hangers

Model No.	Rod Dia. (in.)	Size (in.)	Loads in Various Steel Thicknesses												UL Listed Steel Thickness Range	FM Listed Steel Thickness Range		
			33 mil (20 ga.)		43 mil (18 ga.)		54 mil (16 ga.)		68 mil (14 ga.)		97 mil (12 ga.)		3/16"				1/4"	
			Ult. (lb.)	Allow. (lb.)	Ult. (lb.)	Allow. (lb.)	Ult. (lb.)	Allow. (lb.)	Ult. (lb.)	Allow. (lb.)	Ult. (lb.)	Allow. (lb.)	Ult. (lb.)	Allow. (lb.)			Ult. (lb.)	Allow. (lb.)
RSH25112-5	1/4	#12–20 x 1 1/2	420	155	685	255	835	310	930	310	1,240	425	1,270	425	1,350	500	—	—
RSH25100N <sup>3</sup>	1/4	1/4 x 1	1,150	385	1,235	455	1,235	455	1,235	455	1,480	545	—	—	—	—	—	—
RSH37100N <sup>3</sup>	3/8	1/4 x 1	1,575	525	1,865	665	1,865	665	1,865	665	1,865	665	—	—	—	—	18 ga. – 12 ga.	16 ga. – 12 ga.
RSH37112N-5 <sup>3</sup>	3/8	#12–20 x 1 1/2	1,490	550	1,490	550	1,490	550	1,490	550	1,490	550	1,490	550	1,490	550	18 ga. – 1/4"	16 ga. – 1/4"

1. Allowable loads are based on a factor of safety calculated in accordance with AISI S100 Section F1.
2. Mechanical and plumbing design codes may prescribe lower allowable loads. Verify with local codes.
3. Model requires installation with supplied retaining nut.
4. Values are based on steel members with the following minimum yield and tensile strengths:
  - 43 mil (18 ga.) and 33 mil (20 ga.):  $F_y = 33$  ksi and  $F_u = 45$  ksi
  - 54 mil (16 ga.) to 97 mil (12 ga.):  $F_y = 50$  ksi and  $F_u = 65$  ksi
  - 3/16" and 1/4":  $F_y = 36$  ksi and  $F_u = 58$  ksi.
5. Minimum edge distance must be 1" and minimum spacing must be 2".
6. Acceptability of base material deflection due to imposed loads must be investigated separately.

### Horizontal Installation

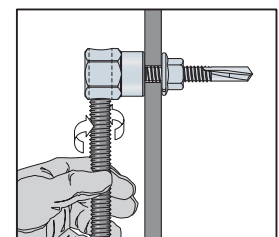
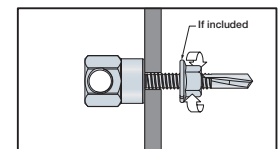
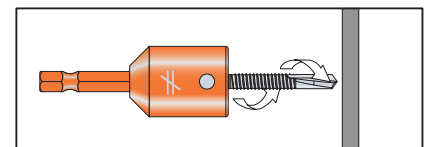
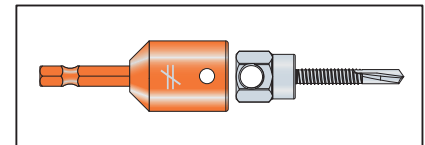

### Vertical Installation

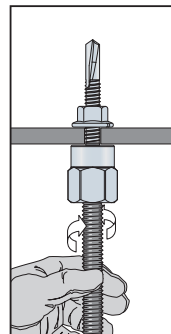
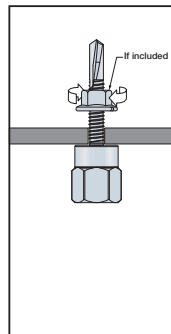
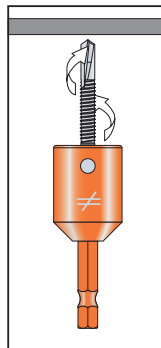
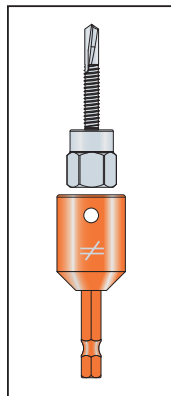

\* See p. 12 for an explanation of the load table icons.

# Wood Rod Hanger Threaded Rod Anchor System

The wood rod hanger from Simpson Strong-Tie is a one-piece fastening system for suspending 1/4" or 3/8" threaded rod. Vertical rod hangers are designed to suspend threaded rod in overhead applications from wood members. Horizontal rod hangers are available for applications requiring installation into the side of joists, columns and overhead members. Both rod hangers provide attachment points for use in pipe hanging, fire protection, electrical conduit and cable-tray applications. Recommended for use in dry, interior, non-corrosive environments only.

## Features

- Threaded anchors for rod-hanging applications in wood
- Suitable for installation horizontally or vertically in overhead applications
- No predrilling required
- Type-17 point provides for fast starts
- Recommend installation with a 18V cordless drill/driver or 18V cordless impact driver

**Codes:** FM 3058980;  
UL File Ex3605

**Material:** Carbon steel

**Coating:** Zinc plated



**RWH**  
**Horizontal Wood**  
**Rod Hanger**



**RWV**  
**Vertical Wood**  
**Rod Hanger**

## Wood Rod Hangers

Rod Diameter (in.)	Size (in.)	Model No.	Application	Point Style	Quantity	
					Box	Carton
1/4	1/4 x 2	RWV25200	Vertical	Type 17	25	250
3/8	1/4 x 1	RWV37100				
3/8	1/4 x 2	RWV37200				
3/8	5/16 x 2 1/2	RWV37212				
1/4	1/4 x 1	RWH25100	Horizontal	Type 17	25	250
3/8	1/4 x 2	RWH37200				
3/8	5/16 x 2 1/2	RWH37212				



**Type-17 point for**  
**use in wood**

# Wood Rod Hanger Design Information — Wood



## Tension Wood Rod Hanger Allowable Loads

Model No.	Rod Dia. (in.)	Size (in.)	Minimum Edge Distance (in.)	Minimum End Distance (in.)	Minimum Spacing (in.)	Allowable Tension Loads (lb.)			Pipe Size (in.)	
						DF	SP	SPF	UL Approval	FM Approval
RWW25200	¼	¼ x 2	¾	2¾	2¾	375	435	310	—	—
RWW37100	⅜	¼ x 1				155	190	105	—	—
RWW37200	⅜	¼ x 2				375	435	310	3	—
RWW37212	⅜	⅝ x 2½		605	590	495	4	4		

1. Load values are based on full shank penetration into the wood member.
2. Allowable loads may be increased by CD = 1.6 for wind or earthquake.
3. Allowable loads are based on a factor of safety of 5.0.
4. Mechanical and plumbing design codes may prescribe lower allowable loads. Verify with local codes.
5. Allowable loads are based on Douglas Fir-Larch (DF), Southern Pine (SP) and Spruce-Pine-Fir (SPF) wood members having a minimum specific gravity of 0.50, 0.55 and 0.42, respectively.



## Shear Wood Rod Hanger Allowable Loads

Model No.	Rod Dia. (in.)	Size (in.)	Minimum Edge Distance (in.)	Minimum End Distance (in.)	Minimum Spacing (in.)	Allowable Shear Loads (lb.)			Pipe Size (in.)
						DF	SP	SPF	UL Approval
RWH25100	¼	¼ x 1	1	2¾	2¾	110	135	85	—
RWH37200	⅜	¼ x 2	2½			240	225	330	3
RWH37212	⅜	⅝ x 2½		3¼	3¼	230	265	240	3

1. Load values are based on full shank penetration into the wood member.
2. Allowable loads may not be increased for short-term loading.
3. Allowable loads are based on a factor of safety of 5.0.
4. Mechanical and plumbing design codes may prescribe lower allowable loads. Verify with local codes.
5. Allowable loads are based on Douglas Fir-Larch (DF), Southern Pine (SP) and Spruce-Pine-Fir (SPF) wood members having a minimum specific gravity of 0.50, 0.55 and 0.42, respectively.

## Installation Sequence

1. Attach RND62 nut driver to a drill.
2. Insert rod hanger into the RND62 nut driver.
3. Using rotation-only mode, drive rod hanger until it contacts the surface. Do not over-tighten. RND62 nut driver will disengage the rod hanger at the appropriate depth to prevent over-driving.
4. Insert threaded rod. Minimum thread engagement should be equal to the nominal diameter of the threaded insert.

## Vertical Wood Rod Hanger

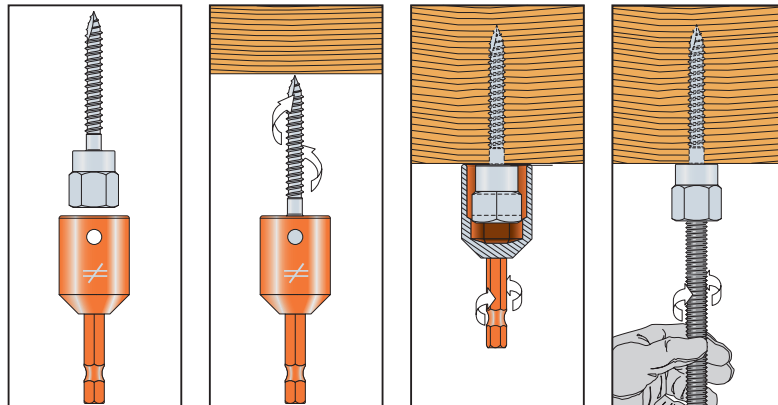

## Horizontal Wood Rod Hanger

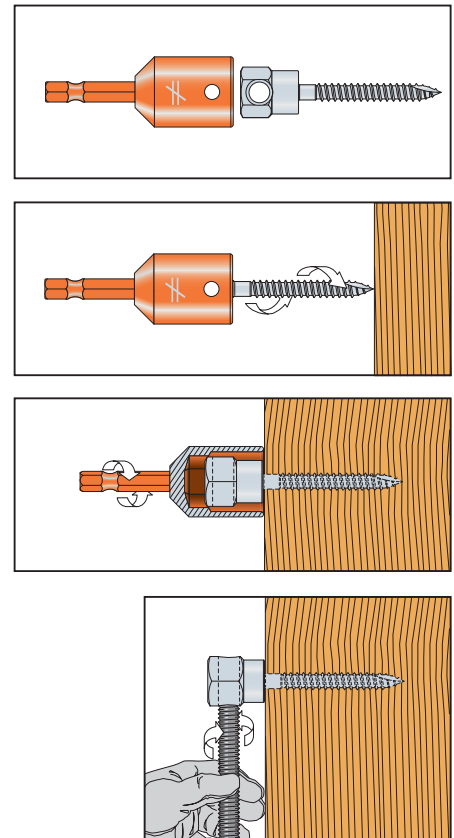

\* See p. 12 for an explanation of the load table icons.

## Drop-In Internally Threaded Anchor (DIAB)

### Expansion shell anchors for use in solid base materials

Simpson Strong-Tie introduces a redesigned Drop-In Anchor (DIAB) that provides easier installation into base materials. Improved geometry in the preassembled expansion plug improves setting capability so the anchor installs with 40% fewer hammer strikes than previous versions. These displacement-controlled expansion anchors are easily set by driving the plug toward the bottom of the anchor using either the hand- or power-setting tools. DIAB anchors feature a positive-set marking indicator at the top of the anchor — helping you see more clearly when proper installation has taken place.

Use a Simpson Strong-Tie fixed-depth stop bit to take the guesswork out of drilling to the correct depth. The fluted design of the tip draws debris away from the hole during drilling, allowing for a cleaner installation.

#### Key features

- New design offers easier installation than previous drop-in anchor design — sets with 40% fewer hammer hits
- Positive-set marking system indicates when anchor is properly set
- Lipped drop-in version available for flush installation
- Hand- and power-setting tools available for fast, easy and economical installation
- Fixed-depth stop bit helps you drill to the correct depth every time
- Available in coil-thread version for ½" and ¾" coil-thread rod

**Codes:** FM 3053987; UL File Ex3605; Multiple DOT listings; Meets the requirements of Federal Specification A-A-55614, Type 1

**Material:** Carbon steel

**Coating:** Zinc plated



Drop-In



Lipped Drop-In



Coil-Thread Drop-In

#### Fixed-Depth Drill Bits for DIAB

Model No.	Drill Bit Diameter (in.)	Drill Depth (in.)	Drop-In Anchor (in.)
MDPL037DIA	3/8	1 1/16	1/4
MDPL050DIA	1/2	1 11/16	3/8
MDPL062DIA	5/8	2 1/16	1/2



Fixed-Depth Drill Bit

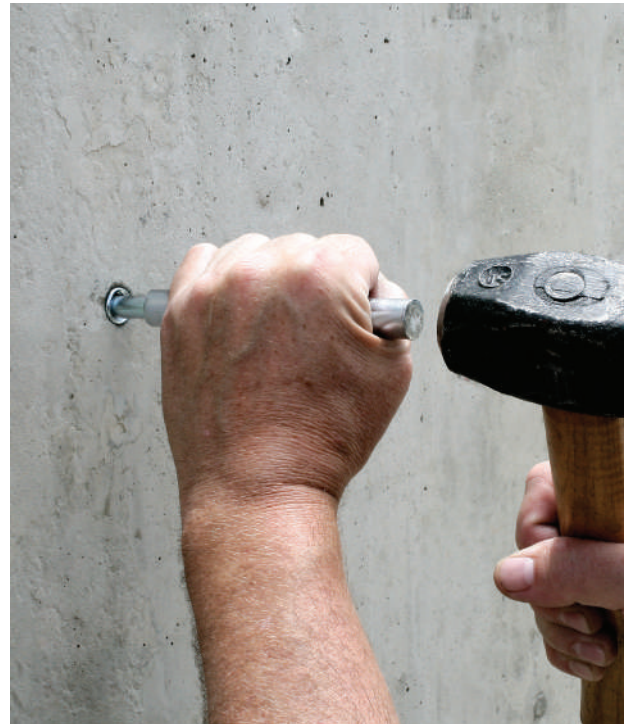

Anchor being set with hand setting tool.



Anchor being set with SDS setting tool.



Positive set indicator.



# Drop-In Internally Threaded Anchor (DIAB)

## Drop-In Anchor

Rod Size (in.)	Model No.	Drill Bit Dia. (in.)	Bolt Threads (per in.)	Body Length (in.)	Thread Length (in.)	Quantity	
						Box	Carton
¼	DIAB25	⅜	20	1	⅜	100	500
⅜	DIAB37	½	16	1⅞	⅝	50	250
½	DIAB50	⅝	13	2	¾	50	200
⅝	DIAB62	⅞	11	2½	1	25	100
¾	DIAB75	1	10	3⅝	1¼	20	80



Drop-In

## Lipped Drop-In Anchor

Rod Size (in.)	Model No.	Drill Bit Dia. (in.)	Bolt Threads (per in.)	Body Length (in.)	Thread Length (in.)	Quantity	
						Box	Carton
¼	DIABL25	⅜	20	1	⅜	100	500
⅜	DIABL37	½	16	1⅞	⅝	50	250
½	DIABL50	⅝	13	2	¾	50	200



Lipped Drop-In

## Coil-Thread Drop-In Anchor

Rod Size (in.)	Model No.	Drill Bit Dia. (in.)	Bolt Threads (per in.)	Body Length (in.)	Thread Length (in.)	Quantity	
						Box	Carton
½	DIAB50C <sup>1</sup>	⅝	6	2	¾	50	200
¾	DIAB75C <sup>1</sup>	1	4½	3⅝	1¼	20	80



Coil-Thread Drop-In

1. DIAB50C and DIAB75C accept ½" and ¾" coil-thread rod, respectively.

## Drop-In Anchor Hand-Setting Tool

Model No.	Description	Box Quantity	Carton Qty.
DIABST25	Setting tool for use with Drop-In models DIAB25, DIABL25	10	50
DIABST37	Setting tool for use with Drop-In models DIAB37, DIABL37	10	50
DIABST50	Setting tool for use with Drop-In models DIAB50, DIABL50, DIAB50C	10	50
DIABST62	Setting tool for use with Drop-In model DIAB62	5	25
DIABST75	Setting tool for use with Drop-In models DIAB75, DIAB75C	5	20



Hand-Setting Tool

1. Setting tools sold separately. Tools may be ordered by the piece.

## Drop-In Anchor Power-Setting Tool (SDS-plus®)

Model No.	Description	Box Quantity	Carton Qty.
DIABST25-SDS	Power-setting tool for use with Drop-In models DIAB25, DIABL25	10	50
DIABST37-SDS	Power-setting tool for use with Drop-In models DIAB37, DIABL37	10	50
DIABST50-SDS	Power-setting tool for use with Drop-In models DIAB50, DIABL50, DIAB50C	10	50



Power-Setting Tool

1. Setting tools sold separately. Tools may be ordered by the piece.

# Drop-In Internally Threaded Anchor (DIAB)

## DIAB Manual Installation

**⚠ Caution:** Oversized holes will reduce the anchors load capacity

1. Drill a hole in the base material using the appropriate diameter carbide drill bit or fixed depth bit as specified in the table. Drill the hole to the specified embedment. For fixed depth bits drill the hole until the shoulder of the bit contacts the surface of the base material. Then blow the hole clean of dust and debris using compressed air. Overhead installations need not be blown clean.
2. Insert the anchor into the hole. Tap with hammer until flush against the surface.
3. Using the designated Drop-In setting tool, drive expander plug towards the bottom of the anchor until the shoulder of the setting tool makes contact with the top of the anchor. When properly set 4 indentations will be visible on the top of the anchor indicating full expansion.
4. Insert bolt or threaded rod. Minimum thread engagement should be equal to the nominal diameter of the threaded insert.

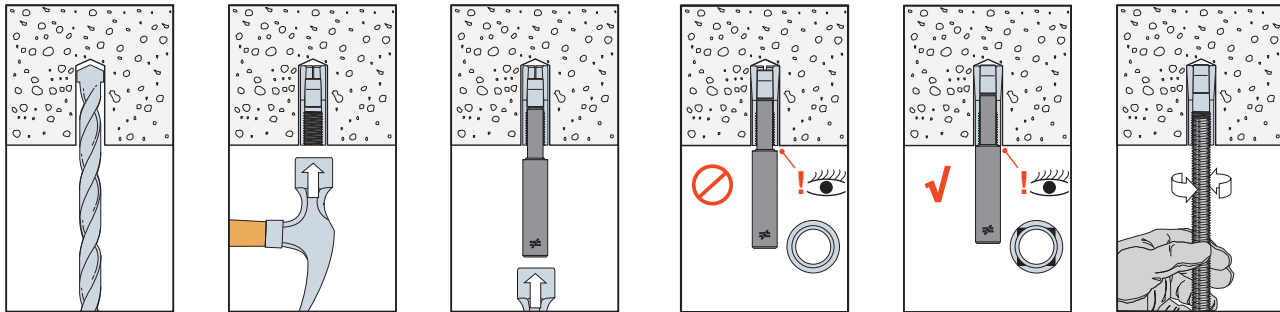

## DIAB SDS Installation

**⚠ Caution:** Oversized holes will reduce the anchors load capacity

1. Drill a hole in the base material using the appropriate diameter carbide drill bit or fixed depth drill bit as specified in the table. Drill the hole to the specified embedment. For fixed depth bits drill the hole until the shoulder of the bit contacts the surface of the base material. Then blow the hole clean of dust and debris using compressed air. Overhead installations need not be blown clean.
2. Insert the anchor into the hole. Tap with hammer until flush against the surface.
3. Attach SDS Drop-In setting tool to a drill. Drive expander plug towards the bottom of the anchor using only hammer mode until the shoulder of the setting tool makes contact with the top of the anchor. When properly set 4 indentations will be visible on the top of the anchor indicating full expansion.
4. Insert bolt or threaded rod. Minimum thread engagement should be equal to the nominal diameter of the threaded insert.

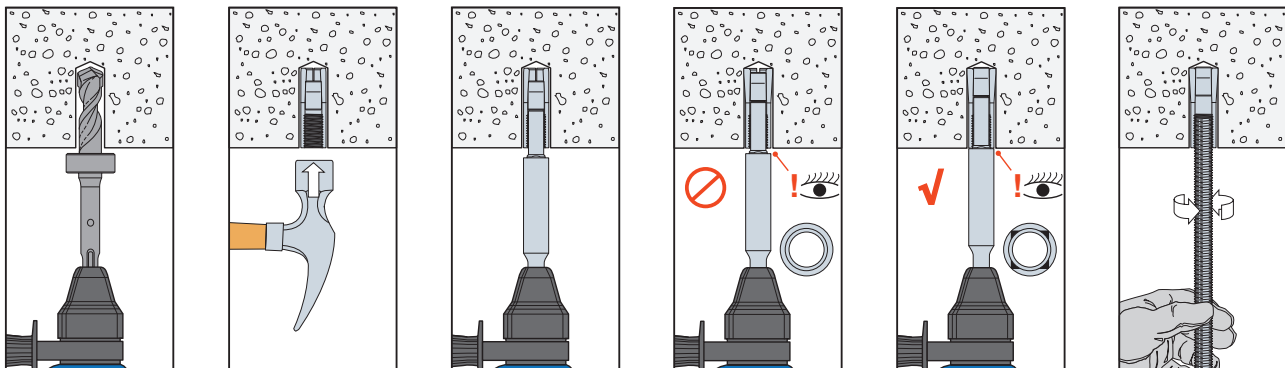

# Drop-In (DIAB) Design Information — Concrete

DIAB Allowable Tension and Shear Loads in Normal-Weight Concrete

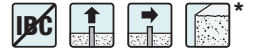

Model No.	Rod Size in. (mm)	Drill Bit Dia. In.	Embed Depth In. (mm)	Critical Edge Dist. In. (mm)	Critical Spacing In. (mm)	$f'_c \geq 2,500$ psi (17.2 MPa)				$f'_c \geq 4,000$ psi (27.6 MPa)			
						Tension Load		Shear Load		Tension Load		Shear Load	
						Ultimate lb. (kN)	Allowable lb. (kN)	Ultimate lb. (kN)	Allowable lb. (kN)	Ultimate lb. (kN)	Allowable lb. (kN)	Ultimate lb. (kN)	Allowable lb. (kN)
DIAB25 DIABL25	¼ (6.4)	⅜	1 (25)	3 (76)	4 (102)	1,565 (7.0)	390 (1.7)	1,840 (8.2)	460 (2.0)	1,965 (8.7)	490 (2.2)	1,840 (8.2)	460 (2.0)
DIAB37 DIABL37	⅜ (9.5)	½	1⅞ (40)	4½ (114)	6 (152)	2,950 (13.1)	740 (3.3)	4,775 (21.2)	1,195 (5.3)	3,910 (17.4)	980 (4.4)	4,775 (21.2)	1,195 (5.3)
DIAB50 DIABL50 DIAB50C	½ (12.7)	⅝	2 (51)	6 (152)	8 (203)	5,190 (23.1)	1,300 (5.8)	6,760 (30.1)	1,690 (7.5)	6,515 (29.0)	1,630 (7.3)	6,760 (30.1)	1,690 (7.5)
DIAB62	⅝ (15.9)	⅞	2½ (64)	7½ (191)	10 (254)	7,010 (31.2)	1,755 (7.8)	12,190 (54.2)	3,050 (13.6)	9,060 (40.3)	2,265 (10.1)	12,190 (54.2)	3,050 (13.6)
DIAB75 DIAB75C	¾ (19.1)	1	3⅞ (79)	9 (229)	12½ (318)	9,485 (42.2)	2,370 (10.5)	15,960 (71.0)	3,990 (17.7)	11,660 (51.9)	2,915 (13.0)	15,960 (71.0)	3,990 (17.7)

1. The allowable loads listed are based on a safety factor of 4.0.
2. Refer to allowable load-adjustment factors for edge distance and spacing on p. 164.
3. Allowable loads may be linearly interpolated between concrete strength listed.
4. The minimum concrete thickness is 1½ times the embedment depth.
5. Allowable loads may not be increased for short-term loading due to wind or seismic forces.

DIAB Allowable Tension and Shear Loads in Soffit of Sand-Lightweight Concrete over Steel Deck



Model No.	Rod Size in. (mm)	Drill Bit Dia. In.	Embed Depth In. (mm)	Critical End Dist. <sup>6</sup> In. (mm)	Critical Spacing In. (mm)	$f'_c \geq 3,000$ psi (20.7 MPa)			
						Tension Load		Shear Load	
						Ultimate lb. (kN)	Allowable lb. (kN)	Ultimate lb. (kN)	Allowable lb. (kN)
DIAB37 DIABL37	⅜ (9.5)	½	1⅞ (40)	4½ (114)	6 (152)	2,895 (12.9)	725 (3.2)	3,530 (15.7)	885 (3.9)
DIAB50 DIABL50 DIAB50C	½ (12.7)	⅝	2 (51)	6 (152)	8 (203)	4,100 (18.2)	1,025 (4.6)	4,685 (20.8)	1,170 (5.2)

1. The allowable loads listed are based on a safety factor of 4.0.
2. Allowable loads may not be increased for short-term loading due to wind or seismic forces.
3. Refer to allowable load-adjustment factors for edge distance and spacing on p. 164.
4. Anchors were installed in the center of the bottom flute of the steel deck.
5. Steel deck must be minimum 20-gauge thick with minimum yield strength of 33 ksi.
6. Critical end distance is defined as the distance from end of the slab in the direction of the flute.

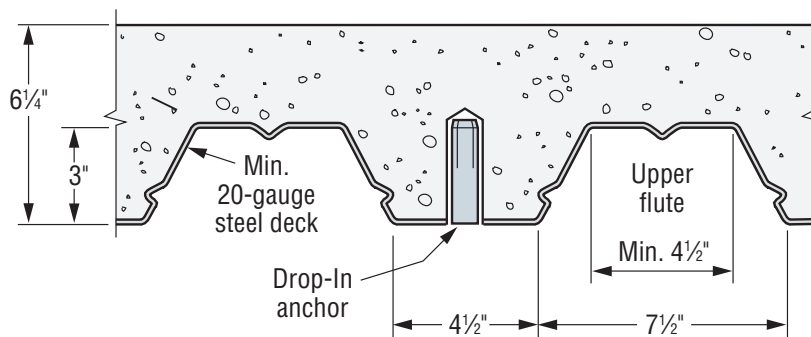

Lightweight Concrete over Steel Deck

\* See p. 12 for an explanation of the load table icons.

# Drop-In (DIAB) Design Information — Concrete

## Allowable Load-Adjustment Factors for Drop-In Anchor (DIAB) in Normal-Weight Concrete and Sand-Lightweight Concrete over Steel Deck: Edge Distance and Spacing, Tension and Shear Loads

### How to use these charts:

- The following tables are for reduced edge distance and spacing.
- Locate the anchor size to be used for either a tension and/or a shear load application.
- Locate the edge distance ( $c_{act}$ ) or spacing ( $s_{act}$ ) at which the anchor is to be installed.
- The load adjustment factor ( $f_c$  or  $f_s$ ) is the intersection of the row and column.
- Multiply the allowable load by the applicable load adjustment factor.
- Reduction factors for multiple edges or spacing are multiplied together.

### Edge Distance Tension ( $f_c$ )

Edge Dist. $c_{act}$ (in.)	Size	1/4	3/8	1/2	5/8	3/4
	$c_{cr}$	3	4 1/2	6	7 1/2	9
	$c_{min}$ $f_{cmin}$	1 3/4	2 5/8	3 1/2	4 3/8	5 1/4
1 3/4	$f_c$	0.77				
2	$f_c$	0.82				
2 1/2	$f_c$	0.91				
2 5/8	$f_c$	0.93	0.77			
3	$f_c$	1.00	0.82			
3 1/2	$f_c$		0.88	0.77		
4	$f_c$		0.94	0.82		
4 3/8	$f_c$		0.98	0.85	0.77	
4 1/2	$f_c$		1.00	0.86	0.78	
5	$f_c$			0.91	0.82	
5 1/4	$f_c$			0.93	0.83	0.77
5 1/2	$f_c$			0.95	0.85	0.79
6	$f_c$			1.00	0.89	0.82
6 1/2	$f_c$				0.93	0.85
7	$f_c$				0.96	0.88
7 1/2	$f_c$				1.00	0.91
8	$f_c$					0.94
8 1/2	$f_c$					0.97
9	$f_c$					1.00



### Edge Distance Shear ( $f_c$ )

Edge Dist. $c_{act}$ (in.)	Size	1/4	3/8	1/2	5/8	3/4
	$c_{cr}$	3	4 1/2	6	7 1/2	9
	$c_{min}$ $f_{cmin}$	1 3/4	2 5/8	3 1/2	4 3/8	5 1/4
1 3/4	$f_c$	0.54				
2	$f_c$	0.63				
2 1/2	$f_c$	0.82				
2 5/8	$f_c$	0.86	0.54			
3	$f_c$	1.00	0.63			
3 1/2	$f_c$		0.75	0.64		
4	$f_c$		0.88	0.71		
4 3/8	$f_c$		0.97	0.77	0.64	
4 1/2	$f_c$		1.00	0.78	0.65	
5	$f_c$			0.86	0.71	
5 1/4	$f_c$			0.89	0.74	0.64
5 1/2	$f_c$			0.93	0.77	0.66
6	$f_c$			1.00	0.83	0.71
6 1/2	$f_c$				0.88	0.76
7	$f_c$				0.94	0.81
7 1/2	$f_c$				1.00	0.86
8	$f_c$					0.90
8 1/2	$f_c$					0.95
9	$f_c$					1.00



- $c_{act}$  = actual edge distance at which anchor is installed (inches).
- $c_{cr}$  = critical edge distance for 100% load (inches).
- $c_{min}$  = minimum edge distance for reduced load (inches).
- $f_c$  = adjustment factor for allowable load at actual edge distance.
- $f_{ocr}$  = adjustment factor for allowable load at critical edge distance.  $f_{ocr}$  is always = 1.00.
- $f_{cmin}$  = adjustment factor for allowable load at minimum edge distance.
- $f_c = f_{cmin} + [(1 - f_{cmin})(c_{act} - c_{min}) / (c_{cr} - c_{min})]$ .

- $c_{act}$  = actual edge distance at which anchor is installed (inches).
- $c_{cr}$  = critical edge distance for 100% load (inches).
- $c_{min}$  = minimum edge distance for reduced load (inches).
- $f_c$  = adjustment factor for allowable load at actual edge distance.
- $f_{ocr}$  = adjustment factor for allowable load at critical edge distance.  $f_{ocr}$  is always = 1.00.
- $f_{cmin}$  = adjustment factor for allowable load at minimum edge distance.
- $f_c = f_{cmin} + [(1 - f_{cmin})(c_{act} - c_{min}) / (c_{cr} - c_{min})]$ .

### Spacing Tension ( $f_s$ )

Spacing $s_{act}$ (in.)	Size	1/4	3/8	1/2	5/8	3/4
	$s_{cr}$	4	6	8	10	12 1/2
	$s_{min}$ $f_{smin}$	1 1/2	2 1/4	3	3 3/4	4 3/4
1 1/2	$f_s$	0.72				
2	$f_s$	0.78				
2 1/4	$f_s$	0.80	0.72			
2 1/2	$f_s$	0.83	0.74			
3	$f_s$	0.89	0.78	0.80		
3 1/2	$f_s$	0.94	0.81	0.82		
3 3/4	$f_s$	0.97	0.83	0.83	0.80	
4	$f_s$	1.00	0.85	0.84	0.81	
4 1/2	$f_s$		0.89	0.86	0.82	
4 3/4	$f_s$		0.91	0.87	0.83	0.80
5	$f_s$		0.93	0.88	0.84	0.81
5 1/2	$f_s$		0.96	0.90	0.86	0.82
6	$f_s$		1.00	0.92	0.87	0.83
6 1/2	$f_s$			0.94	0.89	0.85
7	$f_s$			0.96	0.90	0.86
7 1/2	$f_s$			0.98	0.92	0.87
8	$f_s$			1.00	0.94	0.88
8 1/2	$f_s$				0.95	0.90
9	$f_s$				0.97	0.91
9 1/2	$f_s$				0.98	0.92
10	$f_s$				1.00	0.94
10 1/2	$f_s$					0.95
11	$f_s$					0.96
11 1/2	$f_s$					0.97
12	$f_s$					0.99
12 1/2	$f_s$					1.00



### Spacing Shear ( $f_s$ )

Spacing $s_{act}$ (in.)	Size	1/4	3/8	1/2	5/8	3/4
	$s_{cr}$	4	6	8	10	12 1/2
	$s_{min}$ $f_{smin}$	1 1/2	2 1/4	3	3 3/4	4 3/4
1 1/2	$f_s$	1.00				
2	$f_s$	1.00				
2 1/4	$f_s$	1.00	1.00			
2 1/2	$f_s$	1.00	1.00			
3	$f_s$	1.00	1.00	1.00		
3 1/2	$f_s$	1.00	1.00	1.00		
3 3/4	$f_s$	1.00	1.00	1.00	1.00	
4	$f_s$	1.00	1.00	1.00	1.00	
4 1/2	$f_s$		1.00	1.00	1.00	
4 3/4	$f_s$		1.00	1.00	1.00	1.00
5	$f_s$		1.00	1.00	1.00	1.00
5 1/2	$f_s$		1.00	1.00	1.00	1.00
6	$f_s$		1.00	1.00	1.00	1.00
6 1/2	$f_s$			1.00	1.00	1.00
7	$f_s$			1.00	1.00	1.00
7 1/2	$f_s$			1.00	1.00	1.00
8	$f_s$			1.00	1.00	1.00
8 1/2	$f_s$				1.00	1.00
9	$f_s$				1.00	1.00
9 1/2	$f_s$				1.00	1.00
10	$f_s$				1.00	1.00
10 1/2	$f_s$					1.00
11	$f_s$					1.00
11 1/2	$f_s$					1.00
12	$f_s$					1.00
12 1/2	$f_s$					1.00



- $s_{act}$  = actual spacing distance at which anchor is installed (inches).
- $s_{cr}$  = critical spacing distance for 100% load (inches).
- $s_{min}$  = minimum spacing distance for reduced load (inches).
- $f_s$  = adjustment factor for allowable load at actual spacing distance.
- $f_{ocr}$  = adjustment factor for allowable load at critical spacing distance.  $f_{ocr}$  is always = 1.00.
- $f_{smin}$  = adjustment factor for allowable load at minimum spacing distance.
- $f_s = f_{smin} + [(1 - f_{smin})(s_{act} - s_{min}) / (s_{cr} - s_{min})]$ .

- $s_{act}$  = actual spacing distance at which anchor is installed (inches).
- $s_{cr}$  = critical spacing distance for 100% load (inches).
- $s_{min}$  = minimum spacing distance for reduced load (inches).
- $f_s$  = adjustment factor for allowable load at actual spacing distance.
- $f_{ocr}$  = adjustment factor for allowable load at critical spacing distance.  $f_{ocr}$  is always = 1.00.
- $f_{smin}$  = adjustment factor for allowable load at minimum spacing distance.
- $f_s = f_{smin} + [(1 - f_{smin})(s_{act} - s_{min}) / (s_{cr} - s_{min})]$ .

# Drop-In Short / Drop-In Stainless Steel Internally Threaded Anchor (DIA)

Drop-in anchors are internally threaded drop-in expansion anchors for use in flush-mount applications in solid base materials. Available in stainless steel (DIA) or short (DIAS) version. Minimum thread engagement should be equal to the nominal diameter of the threaded insert.

## Features

- Lipped edge (DIAS) eliminates need for precisely drilled hole depth
- Hand- and power-setting tools available for fast, easy and economical installation
- Fixed-depth stop bit helps you drill to the correct depth every time
- Short length (DIAS) enables shallow embedment to help avoid drilling into rebar or pre-stressed/post-tensioned cables
- Short drop-in anchors include a setting tool compatible with the anchor to ensure consistent installation

**Material:** Stainless steel and carbon steel

**Coating:** Zinc plated

**Codes:** DOT; Factory Mutual 3017082; Underwriters Laboratories File Ex3605. Meets requirements of Federal Specifications A-A-55614, Type I.

**Caution:** The load tables list values based upon results from the most recent testing and may not reflect those in current code reports. Where code jurisdictions apply, consult the current reports for applicable load values.

## Installation

1. Drill a hole in the base material using the appropriate diameter carbide drill bit as specified in the table. Drill the hole to the specified embedment depth plus 1/8" for flush mounting. Blow the hole clean using compressed air. Overhead installations need not be blown clean.
2. Insert designated anchor into hole. Tap with hammer until flush against surface.
3. Using the designated drop-in setting tool, drive expander plug toward the bottom of the anchor until shoulder of setting tool makes contact with the top of the anchor.
4. Minimum thread engagement should be equal to the nominal diameter of the threaded insert.

**Caution:** Oversized holes will make it difficult to set the anchor and will reduce the anchor's load capacity.

## Installation Sequence

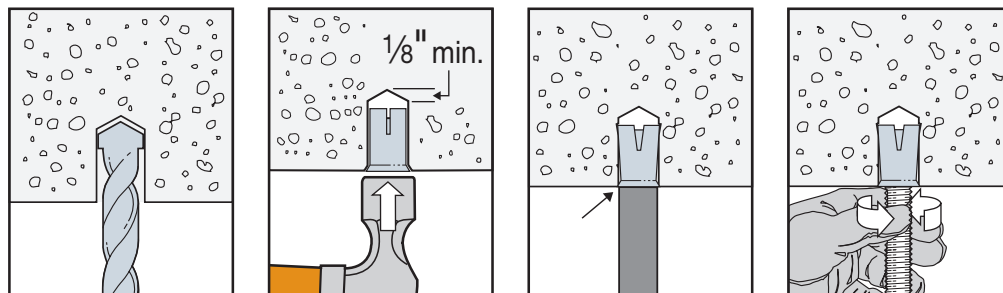

## Drop-In Anchor Product Data — Stainless Steel

Rod Size (in.)	Type 303/304 Stainless Model No.	Type 316 Stainless Model No.	Drill Bit Diameter (in.)	Bolt Threads (per in.)	Body Length (in.)	Thread Length (in.)	Quantity	
							Box	Carton
1/4	DIA25SS	DIA256SS	3/8	20	1	3/8	100	500
3/8	DIA37SS	DIA376SS	1/2	16	1 1/16	5/8	50	250
1/2	DIA50SS	DIA506SS	5/8	13	2	3/4	50	200
5/8	DIA62SS	—	7/8	11	2 1/2	1	25	100
3/4	DIA75SS	—	1	10	3 1/8	1 1/4	20	80



Drop-In  
Stainless Steel

Short  
Drop-In

## Fixed-Depth Drill Bits

Model No.	Drill Bit Diameter (in.)	Drill Depth (in.)	Drop-In Anchor (in.)
<b>Stainless-Steel Drop-In Anchors (DIA)</b>			
MDPL037DIA	3/8	1 1/16	1/4
MDPL050DIA	1/2	1 11/16	3/8
MDPL062DIA	5/8	2 1/16	1/2
<b>Short Drop-In Anchors (DIAS)</b>			
MDPL050DIAS	1/2	1 3/16	3/8
MDPL062DIAS	5/8	1 1/16	1/2



Fixed-Depth  
Drill Bit

# Drop-In Short / Drop-In Stainless Steel Internally Threaded Anchor (DIA)

## Short Drop-In Anchor Product Data

Rod Size (in.)	Model No.	Drill Bit Diameter (in.)	Bolt Threads (per in.)	Body Length (in.)	Thread Length (in.)	Quantity	
						Box	Carton
3/8	DIA37S <sup>1</sup>	1/2	16	3/4	1/4	100	500
1/2	DIA50S <sup>1</sup>	5/8	13	1	5/16	50	200

1. A dedicated setting tool is included with each box of DIA37S and DIA50S.

## Material Specifications

Anchor Component	Component Material		
	Zinc Plated Carbon Steel	Type 303/304 Stainless Steel	Type 316 Stainless Steel
Anchor Body	Meets minimum 70,000 psi tensile	AISI 303. Meets chemical requirements of ASTM A582	Type 316
Expander Plug	Meets minimum 50,000 psi tensile	AISI 303	Type 316
Thread	UNC/Coil-thread	UNC	UNC

## Allowable Tension Loads for Drop-In (Stainless Steel) Anchor in Normal-Weight Concrete



Rod Size in. (mm)	Drill Bit Dia. in. (mm)	Embed. Depth in. (mm)	Critical Edge Dist. in. (mm)	Critical Spacing in. (mm)	Tension Load						
					f' <sub>c</sub> ≥ 2,000 psi (13.8 MPa) Concrete			f' <sub>c</sub> ≥ 3,000 psi (20.7 MPa) Concrete		f' <sub>c</sub> ≥ 4,000 psi (27.6 MPa) Concrete	
					Ultimate lb. (kN)	Std. Dev. lb. (kN)	Allowable lb. (kN)	Allowable lb. (kN)	Ultimate lb. (kN)	Std. Dev. lb. (kN)	Allowable lb. (kN)
1/4 (6.4)	3/8	1 (25)	3 (76)	4 (102)	1,400 (6.2)	201 (0.9)	350 (1.6)	405 (1.8)	1,840 (8.2)	451 (2.0)	460 (2.0)
3/8 (9.5)	1/2	1 1/16 (40)	4 1/2 (114)	6 (152)	2,400 (10.7)	251 (1.1)	600 (2.7)	795 (3.5)	3,960 (17.6)	367 (1.6)	990 (4.4)
1/2 (12.7)	5/8	2 (51)	6 (152)	8 (203)	3,320 (14.8)	372 (1.7)	830 (3.7)	1,178 (5.2)	6,100 (27.1)	422 (1.9)	1,525 (6.8)
5/8 (15.9)	7/8	2 1/2 (64)	7 1/2 (191)	10 (254)	5,040 (22.4)	689 (3.1)	1,260 (5.6)	1,715 (7.6)	8,680 (38.6)	971 (4.3)	2,170 (9.7)
3/4 (19.1)	1	3 1/8 (79)	9 (229)	12 1/2 (318)	8,160 (36.3)	961 (4.3)	2,040 (9.1)	2,365 (10.5)	10,760 (47.9)	1,696 (7.5)	2,690 (12.0)

See footnotes below.

## Allowable Shear Loads for Drop-In (Stainless Steel) Anchor in Normal-Weight Concrete



Rod Size in. (mm)	Drill Bit Dia. in. (mm)	Embed. Depth in. (mm)	Critical Edge Dist. in. (mm)	Critical Spacing in. (mm)	Shear Load					
					f' <sub>c</sub> ≥ 2,000 psi (13.8 MPa) Concrete			f' <sub>c</sub> ≥ 3,000 psi (20.7 MPa) Concrete		f' <sub>c</sub> ≥ 4,000 psi (27.6 MPa) Concrete
					Ultimate lb. (kN)	Std. Dev. lb. (kN)	Allowable lb. (kN)	Allowable lb. (kN)	Allowable lb. (kN)	
1/4 (6.4)	3/8	1 (25)	3 1/2 (89)	4 (102)	1,960 (8.7)	178 (0.8)	490 (2.2)	490 (2.2)	490 (2.2)	
3/8 (9.5)	1/2	1 1/16 (40)	5 1/4 (133)	6 (152)	3,240 (14.4)	351 (1.6)	810 (3.6)	925 (4.1)	1,040 (4.6)	
1/2 (12.7)	5/8	2 (51)	7 (178)	8 (203)	7,000 (31.1)	562 (2.5)	1,750 (7.8)	1,750 (7.8)	1,750 (7.8)	
5/8 (15.9)	7/8	2 1/2 (64)	8 3/4 (222)	10 (254)	11,080 (49.3)	923 (4.1)	2,770 (12.3)	2,770 (12.3)	2,770 (12.3)	
3/4 (19.1)	1	3 1/8 (79)	10 1/2 (267)	12 1/2 (318)	13,800 (61.4)	1,781 (7.9)	3,450 (15.3)	3,725 (16.6)	4,000 (17.8)	

- The allowable loads listed are based on a safety factor of 4.0.
- Refer to allowable load-adjustment factors for edge distance and spacing on p. 168.
- Allowable loads may be linearly interpolated between concrete strengths listed.
- The minimum concrete thickness is 1 1/2 times the embedment depth.

\* See p. 12 for an explanation of the load table icons.

# Drop-In (DIA) Design Information — Concrete

Allowable Tension and Shear Loads for  
 3/8" and 1/2" Short Drop-In Anchor in Sand-Lightweight Concrete Fill over Steel Deck



Model No.	Rod Size (in.)	Drill Bit Dia. (in.)	Emb. Depth (in.)	Tension Critical End Distance (in.)	Shear Critical End Distance (in.)	Critical Spacing (in.)	Install through the Lower Flute or Upper Flute of Steel Deck, $f'_c \geq 3,000$ psi Concrete (20.7 MPa)			
							Tension Load		Shear Load	
							Ultimate (lb.)	Allowable (lb.)	Ultimate (lb.)	Allowable (lb.)
DIA37S	3/8	1/2	3/4	6	7	8	1,344	335	1,649	410
DIA50S	1/2	5/8	1	8	9 3/8	10 3/8	1,711	430	2,070	515

1. The allowable loads listed are based on a safety factor of 4.0.
2. Allowable loads may not be increased for short-term loading due to wind or seismic forces.
3. Refer to allowable load-adjustment factors for edge distances and spacing on p. 169.
4. Anchors were installed with a 1" offset from the centerline of the flute.

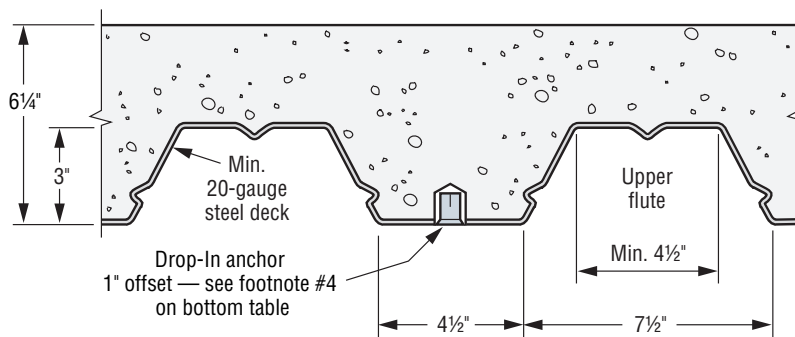

Figure 1. Lightweight Concrete over Steel Deck

Allowable Tension and Shear Loads for  
 3/8" and 1/2" Short Drop-In Anchor in Normal-Weight Concrete



Model No.	Rod Size (in.)	Drill Bit Dia. (in.)	Emb. Depth (in.)	Tension Critical Edge Distance (in.)	Shear Critical Edge Distance (in.)	Critical Spacing (in.)	Normal-Weight Concrete, $f'_c \geq 2,500$ psi				Normal-Weight Concrete, $f'_c \geq 4,000$ psi			
							Tension Load		Shear Load		Tension Load		Shear Load	
							Ultimate (lb.)	Allowable (lb.)	Ultimate (lb.)	Allowable (lb.)	Ultimate (lb.)	Allowable (lb.)	Ultimate (lb.)	Allowable (lb.)
DIA37S	3/8	1/2	3/4	4 1/2	5 1/4	3	1,500	375	2,274	570	2,170	540	3,482	870
DIA50S	1/2	5/8	1	6	7	4	2,039	510	3,224	805	3,420	855	5,173	1,295

1. The allowable loads listed are based on a safety factor of 4.0.
2. Allowable loads may not be increased for short-term loading due to wind or seismic forces.
3. Refer to allowable load-adjustment factors for edge distances and spacing on p. 168.
4. Allowable loads may be linearly interpolated between concrete strengths.
5. The minimum concrete thickness is 1 1/2 times the embedment depth.

Allowable Tension and Shear Loads for  
 3/8" and 1/2" Short Drop-In Anchor in Hollow-Core Concrete Panel



Model No.	Rod Size (in.)	Drill Bit Dia. (in.)	Emb. Depth (in.)	Tension Critical Edge Distance (in.)	Shear Critical Edge Distance (in.)	Critical Spacing (in.)	Hollow Core Concrete Panel, $f'_c \geq 4,000$ psi			
							Tension Load		Shear Load	
							Ultimate (lb.)	Allowable (lb.)	Ultimate (lb.)	Allowable (lb.)
DIA37S	3/8	1/2	3/4	4 1/2	5 1/4	3	1,860	465	3,308	825
DIA50S	1/2	5/8	1	6	7	4	2,650	660	4,950	1,235

1. The allowable loads listed are based on a safety factor of 4.0.
2. Allowable loads may not be increased for short-term loading due to wind or seismic forces.
3. Refer to allowable load-adjustment factors for edge distances and spacing on p. 168.
4. Allowable loads may be linearly interpolated between concrete strengths.

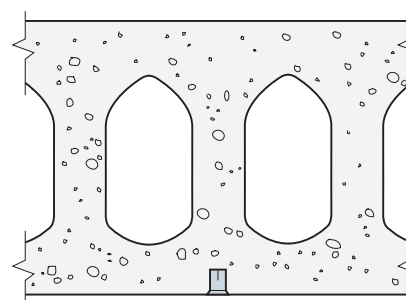

Figure 2. Hollow-Core Concrete Panel  
 (anchor can be installed below web or hollow core)

\* See p. 12 for an explanation of the load table icons.

# Drop-In (DIA) Design Information — Concrete

## Allowable Load-Adjustment Factors for Drop-In (Stainless Steel) and Short Drop-In Anchors in Normal-Weight Concrete: Edge Distance and Spacing, Tension and Shear Loads

### How to use these charts:

1. The following tables are for reduced edge distance and spacing.
2. Locate the anchor size to be used for either a tension and/or shear load application.
3. Locate the edge distance ( $c_{act}$ ) or spacing ( $s_{act}$ ) at which the anchor is to be installed.
4. The load adjustment factor ( $f_c$  or  $f_s$ ) is the intersection of the row and column.
5. Multiply the allowable load by the applicable load adjustment factor.
6. Reduction factors for multiple edges or spacing are multiplied together.

### Edge Distance Tension ( $f_c$ )

Edge Dist. $c_{act}$ (in.)	Size	1/4	3/8	1/2	5/8	3/4
	$c_{cr}$	3	4 1/2	6	7 1/2	9
$c_{min}$	1 3/4	2 5/8	3 1/2	4 3/8	5 1/4	
$f_{cmin}$	0.65	0.65	0.65	0.65	0.65	
1 3/4		0.65				
2		0.72				
2 1/2		0.86				
2 5/8		0.90	0.65			
3		1.00	0.72			
3 1/2			0.81	0.65		
4			0.91	0.72		
4 3/8			0.98	0.77	0.65	
4 1/2			1.00	0.79	0.66	
5				0.86	0.72	
5 1/4				0.90	0.75	0.65
5 1/2				0.93	0.78	0.67
6				1.00	0.83	0.72
6 1/2					0.89	0.77
7					0.94	0.81
7 1/2					1.00	0.86
8						0.91
8 1/2						0.95
9						1.00



### Spacing Tension and Shear ( $f_s$ )

$s_{act}$ (in.)	Size	1/4	3/8 <sup>9</sup>	3/8	1/2 <sup>10</sup>	1/2	5/8	3/4
	$E$	1	3/4	1 1/2	1	2	2 1/2	3 1/8
$s_{cr}$	4	3	6	4	8	10	12 1/2	
$s_{min}$	2	1 1/2	3	2	4	5	6 1/4	
$f_{smin}$	0.50	0.50	0.50	0.50	0.50	0.50	0.50	
1 1/2			0.50					
2		0.50	0.67		0.50			
2 1/2		0.63	0.83		0.63			
3		0.75	1.00	0.50	0.75			
3 1/2		0.88		0.58	0.88			
4		1.00		0.67	1.00	0.50		
4 1/2				0.75		0.56		
5				0.83		0.63	0.50	
5 1/2				0.92		0.69	0.55	
6				1.00		0.75	0.60	
6 1/4						0.78	0.63	0.50
7						0.88	0.70	0.56
8						1.00	0.80	0.64
9							0.90	0.72
10							1.00	0.80
11								0.88
12								0.96
12 1/2								1.00



See notes below.

### Edge Distance Shear ( $f_c$ )

Edge Dist. $c_{act}$ (in.)	Size	1/4	3/8	1/2	5/8	3/4
	$c_{cr}$	3 1/2	5 1/4	7	8 3/4	10 1/2
$c_{min}$	1 3/4	2 5/8	3 1/2	4 3/8	5 1/4	
$f_{cmin}$	0.45	0.45	0.45	0.45	0.45	
1 3/4		0.45				
2		0.53				
2 1/2		0.69				
2 5/8		0.73	0.45			
3		0.84	0.53			
3 1/2		1.00	0.63	0.45		
4			0.74	0.53		
4 3/8			0.82	0.59	0.45	
4 1/2			0.84	0.61	0.47	
5			0.95	0.69	0.53	
5 1/4			1.00	0.73	0.56	0.45
5 1/2				0.76	0.59	0.48
6				0.84	0.65	0.53
6 1/2				0.92	0.72	0.58
7				1.00	0.78	0.63
7 1/2					0.84	0.69
8					0.91	0.74
8 1/2					0.97	0.79
8 3/4					1.00	0.82
9						0.84
9 1/2						0.90
10						0.95
10 1/2						1.00

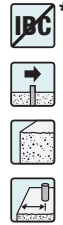

1.  $E$  = Embedment depth (inches).
2.  $s_{act}$  = actual spacing distance at which anchors are installed (inches).
3.  $s_{cr}$  = critical spacing distance for 100% load (inches).
4.  $s_{min}$  = minimum spacing distance for reduced load (inches).
5.  $f_s$  = adjustment factor for allowable load at actual spacing distance.
6.  $f_{scr}$  = adjustment factor for allowable load at critical spacing distance.  $f_{scr}$  is always = 1.00.
7.  $f_{smin}$  = adjustment factor for allowable load at minimum spacing distance.
8.  $f_s = f_{smin} + [(1 - f_{smin})(s_{act} - s_{min}) / (s_{cr} - s_{min})]$ .
9. 3/8" short drop-in (DIA37S).
10. 1/2" short Drop-in (DIA50S)

1.  $c_{act}$  = actual edge distance at which anchor is installed (inches).
2.  $c_{cr}$  = critical edge distance for 100% load (inches).
3.  $c_{min}$  = minimum edge distance for reduced load (inches).
4.  $f_c$  = adjustment factor for allowable load at actual edge distance.
5.  $f_{ccr}$  = adjustment factor for allowable load at critical edge distance.  $f_{ccr}$  is always = 1.00.
6.  $f_{cmin}$  = adjustment factor for allowable load at minimum edge distance.
7.  $f_c = f_{cmin} + [(1 - f_{cmin})(c_{act} - c_{min}) / (c_{cr} - c_{min})]$ .

\* See p. 12 for an explanation of the load table icons.



# Drop-In (DIA) Design Information — Concrete

## Allowable Load-Adjustment Factors for Short Drop-in Anchors in Sand-Lightweight Concrete over Steel Deck: Edge Distance and Spacing, Tension and Shear Loads

### How to use these charts:

1. The following tables are for reduced edge distance and spacing.
2. Locate the anchor size to be used for either a tension and/or shear load application.
3. Locate the edge distance ( $c_{act}$ ) or spacing ( $s_{act}$ ) at which the anchor is to be installed.
4. The load adjustment factor ( $f_c$  or  $f_s$ ) is the intersection of the row and column.
5. Multiply the allowable load by the applicable load adjustment factor.
6. Reduction factors for multiple edges or spacing are multiplied together.

### Edge Distance Tension ( $f_c$ )

Edge Dist. $c_{act}$ (in.)	Size	¾	½
	$c_{cr}$	6	8
	$c_{min}$	3½	4¾
	$f_{cmin}$	0.65	0.65
3½		0.65	
4		0.72	
4½		0.79	
4¾		0.83	0.65
5		0.86	0.68
5½		0.93	0.73
6		1.00	0.78
6½			0.84
7			0.89
7½			0.95
8			1.00



See notes below.

### Spacing Tension and Shear ( $f_s$ )

$s_{act}$ (in.)	Size	¾	½
	$s_{cr}$	8	10¾
	$s_{min}$	4	5¼
	$f_{smin}$	0.50	0.50
4		0.50	
4½		0.56	
5		0.63	
5¼		0.66	0.50
6		0.75	0.57
6½		0.81	0.62
7		0.88	0.66
7½		0.94	0.71
8		1.00	0.76
8½			0.80
9			0.85
9½			0.90
10			0.94
10¾			1.00

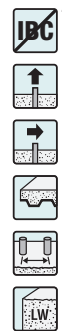

### Edge Distance Shear ( $f_c$ )

Edge Dist. $c_{act}$ (in.)	Size	¾	½
	$c_{cr}$	7	9¾
	$c_{min}$	3½	4¾
	$f_{cmin}$	0.45	0.45
3½		0.45	
4		0.53	
4½		0.61	
4¾		0.65	0.45
5		0.69	0.48
5½		0.76	0.54
6		0.84	0.60
6½		0.92	0.66
7		1.00	0.72
7½			0.78
8			0.84
8½			0.90
9			0.96
9¾			1.00



1.  $s_{act}$  = actual spacing distance at which anchors are installed (inches).
2.  $s_{cr}$  = critical spacing distance for 100% load (inches).
3.  $s_{min}$  = minimum spacing distance for reduced load (inches).
4.  $f_s$  = adjustment factor for allowable load at actual spacing distance.
5.  $f_{s_{cr}}$  = adjustment factor for allowable load at critical spacing distance.  $f_{s_{cr}}$  is always = 1.00.
6.  $f_{s_{min}}$  = adjustment factor for allowable load at minimum spacing distance.
7.  $f_s = f_{s_{min}} + [(1 - f_{s_{min}}) (s_{act} - s_{min}) / (s_{cr} - s_{min})]$ .

1.  $c_{act}$  = actual edge distance at which anchor is installed (inches).
2.  $c_{cr}$  = critical edge distance for 100% load (inches).
3.  $c_{min}$  = minimum edge distance for reduced load (inches).
4.  $f_c$  = adjustment factor for allowable load at actual edge distance.
5.  $f_{c_{cr}}$  = adjustment factor for allowable load at critical edge distance.  $f_{c_{cr}}$  is always = 1.00.
6.  $f_{c_{min}}$  = adjustment factor for allowable load at minimum edge distance.
7.  $f_c = f_{c_{min}} + [(1 - f_{c_{min}}) (c_{act} - c_{min}) / (c_{cr} - c_{min})]$ .

\* See p. 12 for an explanation of the load table icons.

# Hollow Drop-In Internally Threaded Anchor

The Simpson Strong-Tie® Hollow Drop-In Anchor (HDIA) is an internally threaded, flush-mount expansion anchor for use in hollow materials such as CMU and hollow-core plank, as well as in solid base materials such as brick, normal-weight and lightweight concrete.

## Features:

- Suitable for suspending conduit, cable trays, pipe supports, fire sprinklers and suspended lighting into concrete
- Expansion design allows HDIA to anchor into CMU, hollow-core plank, brick, normal-weight concrete and lightweight concrete
- Internally threaded anchor allows for easy bolt removal

**Material:** Die-cast Zamac 3 alloy shell with carbon-steel cone or 304 stainless-steel cone

**Codes:** Factory Mutual 3053987 (3/8"–1/2" diameter)  
Underwriters Laboratories EX3605 (3/8"–1/2" diameter)



Hollow Drop-In

## Hollow Drop-In Anchor

Size (in.)	Model No.	Drill Bit Diameter (in.)	Threads (per in.)	Overall Anchor Length (in.)	Quantity	
					Package Qty.	Carton Qty.
1/4	HDIA25	3/8	20	3/4	100	1,600
1/4	HDIA25SS	3/8	20	3/4	100	1,600
5/16	HDIA31	5/8	18	1 1/4	50	200
3/8	HDIA37	5/8	16	1 1/4	50	200
3/8	HDIA37SS	5/8	16	1 1/4	50	200
1/2	HDIA50	3/4	13	1 3/4	50	250
5/8	HDIA62	1	11	2	25	125

## HDIASTH Setting Tool for Hollow Materials

Setting tool designed to set the Hollow Drop-In internally threaded anchor in hollow materials such as CMU and hollow-core plank.

Model No.	Description	Size (in.)	Carton Qty.
HDIASTH25	Setting tool for use with Hollow Drop-In models HDIA25, HDIA25SS	1/4	25
HDIASTH31	Setting tool for use with Hollow Drop-In model HDIA31	5/16	25
HDIASTH37	Setting tool for use with Hollow Drop-In models HDIA37, HDIA37SS	3/8	25
HDIASTH50	Setting tool for use with Hollow Drop-In model HDIA50	1/2	25
HDIASTH62	Setting tool for use with Hollow Drop-In model HDIA62	5/8	10

1. Tools sold separately. Tools may be ordered by the piece.



HDIASTH Setting Tool

## HDIASTS Setting Tool for Solid Materials

Setting tool designed to set the Hollow Drop-In internally threaded anchor in solid materials such as brick, normal-weight and lightweight concrete.

Model No.	Description	Size (in.)	Box Qty.	Carton Qty.
HDIASTS25	Setting tool for use with Hollow Drop-In models HDIA25, HDIA25SS	1/4	25	125
HDIASTS31-37	Setting tool for use with Hollow Drop-In models HDIA31, HDIA37, HDIA37SS	5/16 – 3/8	10	50
HDIASTS50	Setting tool for use with Hollow Drop-In model HDIA50	1/2	10	50
HDIASTS62	Setting tool for use with Hollow Drop-In model HDIA62	5/8	5	20

1. Tools sold separately. Tools may be ordered by the piece.



HDIASTS Setting Tool

# Hollow Drop-In Internally Threaded Anchor

## Installation Instructions — Solid Base (using solid setting tool)

- Drill a hole in the base material using the appropriate diameter carbide drill bit as specified in the table. Drill the hole to the specified embedment depth.
- Blow the hole clean using compressed air. Overhead installations need not be blown clean.
- Insert the HDIA into hole. Tap with hammer until flush against surface.
- Using the designated setting tool, drive the anchor to the bottom of the drilled hole. After the anchor reaches the bottom of the drilled hole, perform an additional 3 hammer blows against the setting tool to drive the anchor body over the cone.
- Position fixture; insert fastener and tighten.

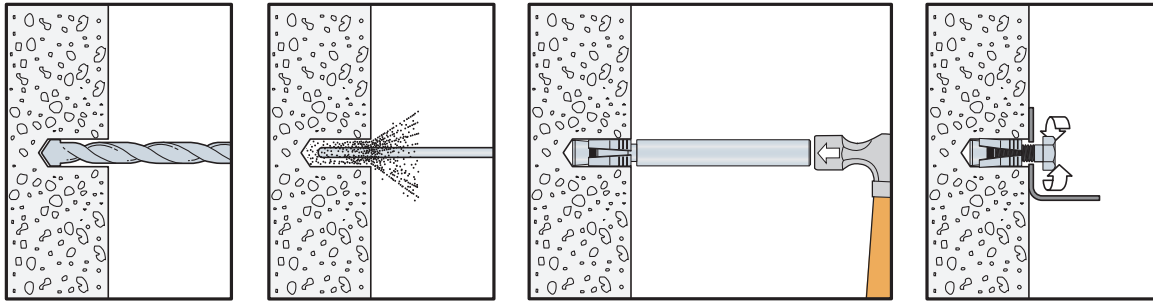

## Installation Instructions — Hollow Base (using hollow setting tool)

- Drill a hole in the base material using the appropriate diameter carbide drill bit as specified in the table.
- Thread the HDIA onto the designated setting tool for hollow base materials.
- Insert the HDIA into the hole. Tap the setting tool until the face of the tool contacts the surface.
- Rotate the setting tool a minimum of 2 turns to set the anchor.
- Remove the setting tool.
- Position fixture; insert fastener and tighten.

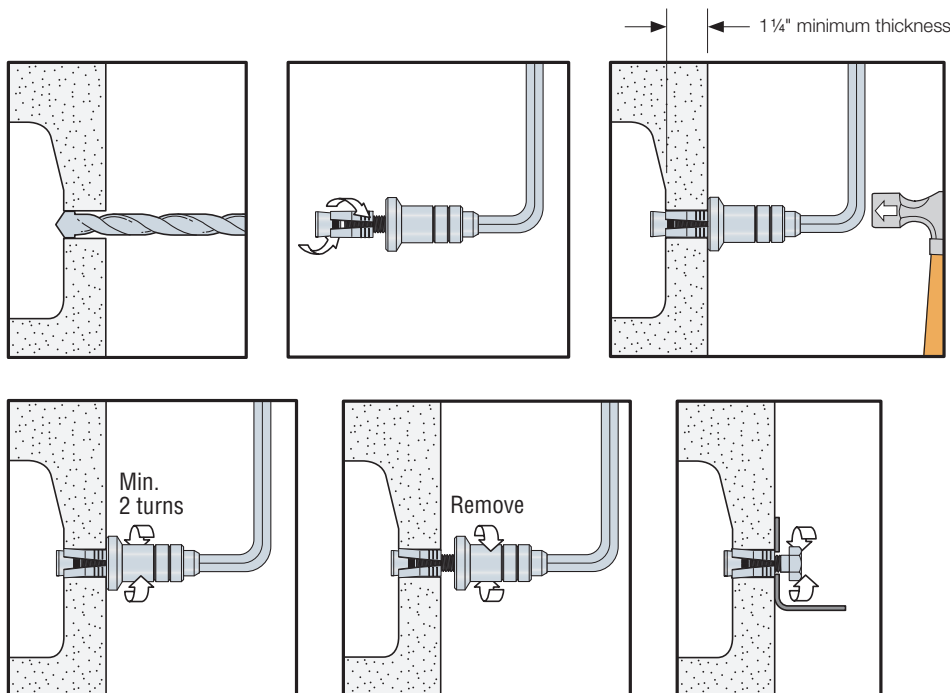

# Hollow Drop-In Design Information — Concrete and Masonry

Allowable Tension Loads for Hollow Drop-In Anchor  
in Normal-Weight Concrete



Model No.	Size in. (mm)	Drill Bit Dia. in. (mm)	Embed Depth in. (mm)	Critical Edge Dist. in. (mm)	Critical Spacing in. (mm)	Tension Load			
						$f'_c \geq 2,500$ psi (17.2 MPa)		$f'_c \geq 4,000$ psi (27.6 MPa)	
						Ultimate lb. (kN)	Allowable lb. (kN)	Ultimate lb. (kN)	Allowable lb. (kN)
HDIA25, HDIA25SS	1/4 (6.4)	3/8 (9.5)	7/8 (22)	2 5/8 (67)	3 1/2 (89)	1,180 (5.2)	295 (1.3)	1,220 (5.4)	305 (1.4)
HDIA31	5/16 (7.9)	5/8 (15.9)	1 1/2 (38)	4 1/2 (114)	6 (152)	3,000 (13.3)	750 (3.3)	3,420 (15.2)	855 (3.8)
HDIA37, HDIA37SS	3/8 (9.5)	5/8 (15.9)	1 1/2 (38)	4 1/2 (114)	6 (152)	3,000 (13.3)	750 (3.3)	3,420 (15.2)	855 (3.8)
HDIA50	1/2 (12.7)	3/4 (19.1)	2 (51)	6 (152)	8 (203)	4,260 (18.9)	1,065 (4.7)	5,500 (24.5)	1,375 (6.1)
HDIA62	5/8 (15.9)	1 (25.4)	2 1/4 (57)	6 3/4 (171)	9 (229)	6,100 (27.1)	1,525 (6.8)	6,300 (28.0)	1,575 (7.0)

1. The allowable loads listed are based on a safety factor of 4.0.
2. The minimum concrete thickness is 1 1/2 times the embedment depth.
3. Allowable loads may be linearly interpolated between concrete strengths listed.

Allowable Shear Loads for Hollow Drop-In Anchor  
in Normal-Weight Concrete



Model No.	Size in. (mm)	Drill Bit Dia. in. (mm)	Embed Depth in. (mm)	Critical Edge Dist. in. (mm)	Critical Spacing in. (mm)	Shear Load Based on Anchor Strength		Shear Load Based on Steel Strength	
						$f'_c \geq 2,500$ psi (17.2 MPa)		F1554 Grade 36	A193 Grade B7
						Ultimate lb. (kN)	Allowable lb. (kN)	Allowable lb. (kN)	Allowable lb. (kN)
HDIA25, HDIA25SS	1/4 (6.4)	3/8 (9.5)	7/8 (22)	2 5/8 (67)	3 1/2 (89)	1,840 (8.2)	460 (2.0)	485 (2.2)	1,045 (4.6)
HDIA31	5/16 (7.9)	5/8 (15.9)	1 1/2 (38)	4 1/2 (114)	6 (152)	2,660 (11.8)	665 (3.0)	755 (3.4)	1,630 (7.3)
HDIA37, HDIA37SS	3/8 (9.5)	5/8 (15.9)	1 1/2 (38)	4 1/2 (114)	6 (152)	3,580 (15.9)	895 (4.0)	1,085 (4.8)	2,340 (10.4)
HDIA50	1/2 (12.7)	3/4 (19.1)	2 (51)	6 (152)	8 (203)	8,220 (36.6)	2,055 (9.1)	1,930 (8.6)	4,160 (18.5)
HDIA62	5/8 (15.9)	1 (25.4)	2 1/4 (57)	6 3/4 (171)	9 (229)	10,180 (45.3)	2,545 (11.3)	3,025 (13.5)	6,520 (29.0)

1. The allowable loads listed are based on a safety factor of 4.0.
2. The minimum concrete thickness is 1 1/2 times the embedment depth.
3. Allowable load must be the lesser of the load based on anchor strength or steel strength.

\* See p. 12 for an explanation of the load table icons.

# Hollow Drop-In Design Information — Concrete and Masonry

Allowable Tension and Shear Loads for Hollow Drop-In Anchor in 8" Lightweight, Medium-Weight and Normal-Weight Hollow CMU

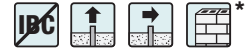

Model No.	Size in. (mm)	Drill Bit Dia. in. (mm)	Embed Depth <sup>4</sup> in. (mm)	Minimum Edge Dist. in. (mm)	Minimum End Dist. in. (mm)	Minimum Spacing in. (mm)	Tension Load		Shear Load	
							Ultimate lb. (kN)	Allowable lb. (kN)	Ultimate lb. (kN)	Allowable lb. (kN)
HDIA25, HDIA25SS	¼ (6.4)	¾ (9.5)	¾ (19)	4 (102)	4½ (117)	8 (203)	500 (2.2)	100 (0.4)	975 (4.3)	195 (0.9)
HDIA31	⅝ (7.9)	¾ (15.9)	1¼ (32)	4 (102)	4½ (117)	8 (203)	500 (2.2)	100 (0.4)	1,450 (6.4)	290 (1.3)
HDIA37, HDIA37SS	¾ (9.5)	¾ (15.9)	1¼ (32)	4 (102)	4½ (117)	8 (203)	500 (2.2)	100 (0.4)	1,450 (6.4)	290 (1.3)
HDIA50	½ (12.7)	¾ (19.1)	1¼ (44)	4 (102)	4½ (117)	8 (203)	1,525 (6.8)	305 (1.4)	2,300 (10.2)	460 (2.0)
HDIA62	⅝ (15.9)	1 (25.4)	2 (51)	4 (102)	4½ (117)	8 (203)	1,525 (6.8)	305 (1.4)	2,325 (10.3)	465 (2.1)

1. The allowable loads listed are based on a safety factor of 5.0.
2. Values for 8-inch wide lightweight, medium-weight, and normal-weight CMU.
3. The minimum specified compressive strength of masonry,  $f_m$ , at 28 days with a minimum face shell thickness of 1¼" is 1,500 psi.
4. The installed end of the anchor may extend into the CMU cavity depending upon face shell thickness.

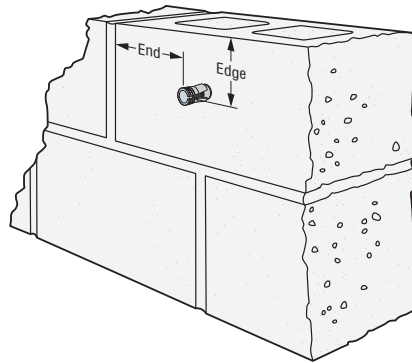

Tension and Shear Loads for Hollow Drop-In Anchor in Hollow-Core Concrete Panel



Model No.	Size in. (mm)	Drill Bit Dia. in. (mm)	Embed Depth <sup>4</sup> in. (mm)	Critical Edge Dist. in. (mm)	Critical Spacing in. (mm)	Tension Load		Shear Load Based on Anchor Strength		Shear Load Based on Steel Strength of Threaded Rod	
						$f'_c \geq 5,000$ psi (34.5 MPa)		$f'_c \geq 5,000$ psi (34.5 MPa)		F1554 Grade 36	A193 Grade B7
						Ultimate lb. (kN)	Allowable lb. (kN)	Ultimate lb. (kN)	Allowable lb. (kN)	Allowable lb. (kN)	Allowable lb. (kN)
HDIA25, HDIA25SS	¼ (6.4)	¾ (9.5)	¾ (19)	3 (76)	4½ (114)	1,340 (6.0)	335 (1.5)	2,040 (9.1)	510 (2.3)	485 (2.2)	1,045 (4.6)
HDIA31	⅝ (7.9)	¾ (15.9)	1¼ (32)	5 (127)	7½ (191)	1,820 (8.1)	455 (2.0)	3,240 (14.4)	810 (3.6)	755 (3.4)	1,630 (7.3)
HDIA37, HDIA37SS	¾ (9.5)	¾ (15.9)	1¼ (32)	5 (127)	7½ (191)	1,820 (8.1)	455 (2.0)	4,560 (20.3)	1,140 (5.1)	1,085 (4.8)	2,340 (10.4)
HDIA50	½ (12.7)	¾ (19.1)	1¼ (44)	7 (178)	10½ (267)	2,840 (12.6)	710 (3.2)	5,820 (25.9)	1,455 (6.5)	1,930 (8.6)	4,160 (18.5)
HDIA62	⅝ (15.9)	1 (25.4)	2 (51)	8 (203)	12 (305)	2,980 (13.3)	745 (3.3)	8,700 (38.7)	2,175 (9.7)	3,025 (13.5)	6,520 (29.0)

1. The allowable loads listed are based on a safety factor of 4.0.
2. The minimum concrete thickness over the open cores is 1¼".
3. The minimum specified compressive strength of the concrete used in the hollow-core panel,  $f'_c$ , is 5,000 psi (34.5 MPa).
4. The installed end of the anchor may extend into the panel cavity depending upon face shell thickness.

\* See p. 12 for an explanation of the load table icons.

# Zinc Nailon™ Pin Drive Anchors

Zinc Nailon anchors are low-cost, easy-to-install anchors for applications under static loads.

## Features



- Available with carbon and stainless-steel pins
- Pin and head configuration designed to make anchor tamper-resistant

## Materials

- Body — Die-cast Zamac 3 alloy
- Pin — Carbon steel; Type 304 stainless steel

**Code:** Meets Federal Specification A-A-1925A, Type 1

## Installation

-  **Caution:** Not for use in overhead applications.
-  **Caution:** Nailon anchors are not recommended for eccentric tension (prying) loads — capacity will be greatly reduced in such applications

1. Drill a hole in base material using a carbide drill bit the same diameter as the nominal diameter of the anchor to be installed. Drill the hole to specified embedment depth, plus ¼" for pin extension, and blow hole clean using compressed air. Alternatively, drill the hole deep enough to accommodate embedment depth and dust from drilling.
2. Position fixture and insert Nailon anchor.
3. Tap with hammer until flush with fixture, then drive pin until flush with top of head.



**Zinc Nailon Anchor**  
(Mushroom)

## Zinc Nailon Product Data

Size (in.)	Carbon Steel Pin Model No.	Stainless Steel Pin Model No.	Quantity		
			Box	Carton	Bulk
3/16 x 7/8	ZN18078	—	100	1,600	3,000
1/4 x 3/4	ZN25034	ZN25034SS	100	500	2,000
1/4 x 1	ZN25100	ZN25100SS	100	500	1,500
1/4 x 1 1/4	ZN25114	ZN25114SS	100	500	1,500
1/4 x 1 1/2	ZN25112	ZN25112SS	100	500	1,000
1/4 x 2	ZN25200	ZN25200SS	100	400	1,000
1/4 x 2 1/2	ZN25212	ZN25212SS	100	400	—
1/4 x 3	ZN25300	ZN25300SS	100	400	1,000

## Allowable Tension and Shear Loads for Zinc Nailon in Normal-Weight Concrete

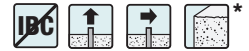

Size (in.)	Drill Bit Dia. (in.)	Embed. Depth (in.)	Ultimate Loads (lb.)		Allowable Loads (lb.) <sup>1</sup>	
			$f'c \geq 3,000$ psi		$f'c \geq 3,000$ psi	
			Tension	Shear	Tension	Shear
3/16	3/16	5/8	460	465	115	115
1/4	1/4	5/8	590	635	150	160
		3/4	780	765	195	190
		1 1/2	1,050	1,050	265	265

1. The allowable loads are based on a safety factor of 4.0.

## Installation Sequence

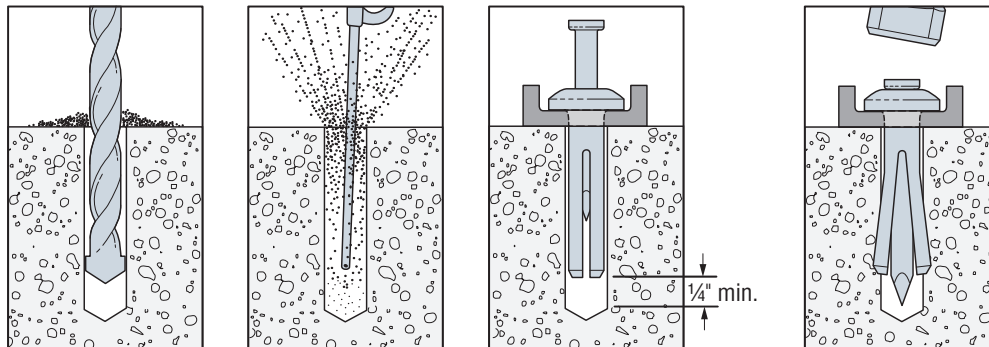

\* See p. 12 for an explanation of the load table icons.

# Crimp Drive® Anchor

The crimp anchor is an easy-to-install expansion anchor for use in concrete and grout-filled block. The pre-formed curvature along the shaft creates an expansion mechanism that secures the anchor in place and eliminates the need for a secondary tightening procedure. This speeds up anchor installation and reduces the overall cost.

Five crimp anchor head styles are available to handle different applications that include fastening wood or light-gauge steel, attaching concrete formwork, hanging overhead support for sprinkler pipes or suspended ceiling panels.

**Material:** Carbon steel, stainless steel

**Coating:** Zinc plated and mechanically galvanized

**Codes:** Factory Mutual 3031136 for the 3/8" rod coupler.

**Head Styles:** Mushroom, rod coupler, countersunk, tie-wire and duplex

## Installation

**Warning:** Industry studies show that hardened fasteners can experience performance problems in wet or corrosive environments. Accordingly, with the exception of the duplex anchor, use these products in dry, interior and non-corrosive environments only.

1. Drill a hole using the specified diameter carbide bit into the base material to a depth of at least 1/2" deeper than the required embedment.
2. Blow the hole clean of dust and debris using compressed air. Overhead application need not be blown clean. Where a fixture is used, drive the anchor through the fixture into the hole until the head sits flush against the fixture.
3. Be sure the anchor is driven to the required embedment depth. The rod coupler and tie-wire models should be driven in until the head is seated against the surface of the base material.



**Mushroom Head**



**Rod Coupler**



**Countersunk Head**



**Tie-Wire**



**Duplex**

## Installation Sequence

### Rod Coupler

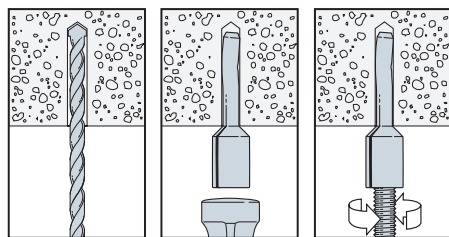

### Tie-Wire

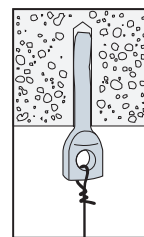

### Mushroom Head

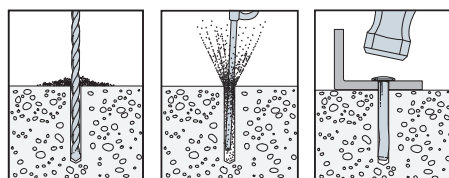

### Duplex

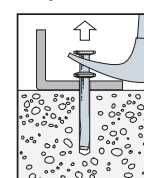

Duplex-head anchor may be removed with a claw hammer

## Countersunk Head Installation Sequence

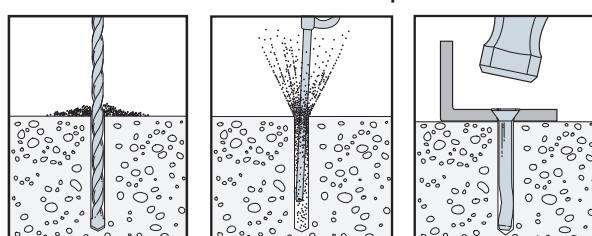

# Crimp Drive® Anchor

## Crimp Drive Anchor Product Data

Mechanical Anchors

Size (in.)	Model No.	Head Style/ Finish	Drill Bit Dia. (in.)	Min. Fixture Hole Size	Min. Embed. (in.)	Quantity				
						Pkg. Qty.	Carton Qty.			
3/16 x 1 1/4	CD18114M	Mushroom Head / Zinc Plated	3/16	1/4	7/8	100	1,600			
3/16 x 2	CD18200M				1 1/4	100	500			
3/16 x 2 1/2	CD18212M				1 1/4	100	500			
3/16 x 3	CD18300M				1 1/4	100	500			
3/16 x 3 1/2	CD18312M				1 1/4	100	500			
3/16 x 4	CD18400M				1 1/4	100	500			
1/4 x 1	CD25100M		Mushroom Head / Zinc Plated	1/4	5/16	7/8	100	1,600		
1/4 x 1 1/4	CD25114M					7/8	100	1,600		
1/4 x 1 1/2	CD25112M					1 1/4	100	1,600		
1/4 x 2	CD25200M					1 1/4	100	500		
1/4 x 2 1/2	CD25212M					1 1/4	100	500		
1/4 x 3	CD25300M					1 1/4	100	500		
1/4 x 3 1/2	CD25312M					1 1/4	100	500		
1/4 x 4	CD25400M					1 1/4	100	500		
3/8 x 2	CD37200M					3/8	7/16	1 3/4	25	125
3/8 x 3	CD37300M							1 3/4	25	125
1/4 x 3	CD25300MG	Mushroom Head / Mechanically Galvanized	1/4	5/16	1 1/4	100	500			
1/4" rod coupler	CD25114RC	Rod Coupler / Zinc Plated	3/16	N/A	1 1/4	100	500			
3/8" rod coupler	CD37112RC		1/4	N/A	1 1/2	50	250			
3/16 x 2 1/2	CD18212C	Countersunk Head / Zinc Plated	3/16	1/4	1 1/4	100	500			
3/16 x 3	CD18300C				1 1/4	100	500			
3/16 x 4	CD18400C				1 1/4	100	500			
1/4 x 1 1/2	CD25112C		1/4	5/16	1 1/4	100	500			
1/4 x 2	CD25200C				1 1/4	100	500			
1/4 x 2 1/2	CD25212C				1 1/4	100	500			
1/4 x 3	CD25300C				1 1/4	100	500			
1/4 x 3 1/2	CD25312C				1 1/4	100	400			
1/4 x 4	CD25400C				1 1/4	100	400			
1/4 x 3	CD25300CMG				Countersunk Head / Mechanically Galvanized <sup>1</sup>	1/4	5/16	1 1/4	100	500
1/4 x 4	CD25400CMG							1 1/4	100	400
1/4" Tie Wire	CD25118T				Tie Wire/Zinc Plated	1/4	N/A	1 1/8	100	500
1/4" duplex	CD25234D	Duplex Head/Zinc Plated	1/4	5/16	1 1/4	100	500			

1. Mechanical galvanizing meets ASTM B695, Class 55, Type 1. Intended for some pressure-treated wood sill plate applications. Not for use in other corrosive or outdoor environments. See p. 261 for details.

### Length Identification Head Marks on Mushroom, Countersunk and Duplex-Head Crimp Drive Anchors (corresponds to length of anchor — inches)

Mark	□	A	B	C	D	E	F
From	1	1 1/2	2	2 1/2	3	3 1/2	4
Up To But Not Including	1 1/2	2	2 1/2	3	3 1/2	4	4 1/2



## Crimp Drive® Design Information — Concrete

Carbon-Steel Crimp Drive Allowable Tension and Shear Loads  
in Normal-Weight Concrete

Size (in.)	Drill Bit Diameter (in.)	Embed. Depth (in.)	Minimum Spacing (in.)	Minimum Edge Distance (in.)	Tension Load		Shear Load	
					$f'_c \geq 2,000$ psi Concrete	$f'_c \geq 4,000$ psi Concrete	$f'_c \geq 2,000$ psi Concrete	$f'_c \geq 4,000$ psi Concrete
					Allowable Load (lb.)	Allowable Load (lb.)	Allowable Load (lb.)	Allowable Load (lb.)
<b>Mushroom/Countersunk Head</b>								
3/16	3/16	1 1/4	3	3	145	250	340	450
1/4	1/4	1 1/4	3	3	175	275	395	610
3/8	3/8	1 3/4	4	4	365	780	755	1,305
<b>Duplex Head</b>								
1/4	1/4	1 1/4	3	3	175	275	395	610
<b>Tie Wire</b>								
1/4	1/4	1 1/8	3	3	155	215	265	325
<b>Rod Coupler<sup>4</sup></b>								
1/4	3/16	1 1/4	3	3	145	250	—	—
3/8	1/4	1 1/2	4	4	265	600	—	—

1. The allowable loads listed are based on a safety factor of 4.0.

2. The minimum concrete thickness is 1 1/2 times the embedment depth.

3. Allowable loads may be linearly interpolated between concrete strengths listed.

4. For rod coupler, mechanical and plumbing design codes may prescribe lower allowable loads; verify with local codes.

\* See p. 12 for an explanation of the load table icons.

# Crimp Drive® Design Information — Concrete

Carbon-Steel Crimp Drive Allowable Tension and Shear Loads  
in Sand-Lightweight Concrete over Steel Deck

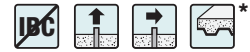

Mechanical Anchors

Size (in.)	Drill Bit Diameter (in.)	Embed. Depth (in.)	Minimum Spacing (in.)	Minimum Edge Distance (in.)	Tension Load (Install in Concrete)	Tension Load (Install Through Steel Deck)	Shear Load (Install in Concrete)	Shear Load (Install Through Steel Deck)
					$f'_c \geq 3,000$ psi Concrete	$f'_c \geq 3,000$ psi Concrete	$f'_c \geq 3,000$ psi Concrete	$f'_c \geq 3,000$ psi Concrete
					Allowable Load (lb.)	Allowable Load (lb.)	Allowable Load (lb.)	Allowable Load (lb.)
<b>Mushroom/Countersunk Head</b>								
3/16	3/16	1 1/4	4	4	115	85	345	600
1/4	1/4	1 1/4	4	4	145	130	375	890
3/8	3/8	1 3/4	5 1/2	5 1/2	315	330	1,030	1,085
<b>Duplex Head</b>								
1/4	1/4	1 1/4	4	4	145	130	375	890
<b>Tie Wire</b>								
1/4	1/4	1 1/8	3	3	130	90	275	210
<b>Rod Coupler<sup>4</sup></b>								
1/4	3/16	1 1/4	4	4	115	85	—	—
3/8	1/4	1 1/2	5	5	300	280	—	—

1. The allowable loads listed are based on a safety factor of 4.0.
2. The minimum concrete thickness is 1 1/2 times the embedment depth.
3. Anchors may be installed off-center in the flute, up to 1" from the center of flute.
4. Anchor may be installed in either upper or lower flute.
5. Deck profile shall be 3" deep, 20-gauge minimum.
6. For rod coupler, mechanical and plumbing design codes may prescribe lower allowable loads; verify with local codes.

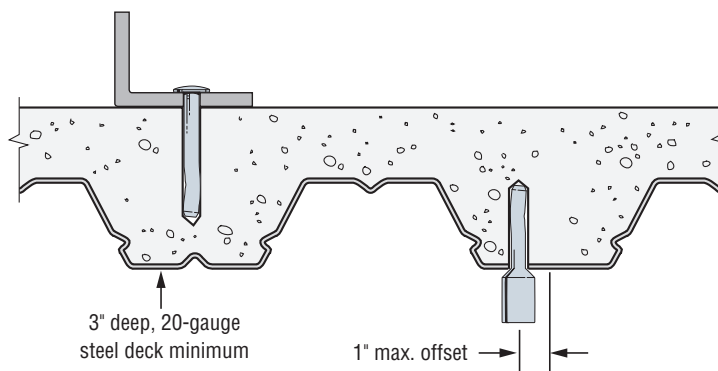

**Figure 1.** Sand-Lightweight Concrete on Steel Deck

\* See p. 12 for an explanation of the load table icons.

## CSD/DSD Split-Drive Anchors

The Split-Drive anchor is a one-piece expansion anchor that can be installed in concrete, grout-filled block and stone. As the anchor is driven in, the split-type expansion mechanism on the working end compresses and exerts force against the walls of the hole.

### Features

- Available in countersunk (CSD) and duplex-head (DSD) styles
- DSD anchor can be removed with a claw hammer for temporary applications

**Material:** Carbon steel

**Coating:** Zinc plated; mechanically galvanized

### Installation

**Warning (CSD only):** Industry studies show that hardened fasteners can experience performance problems in wet or corrosive environments. Accordingly, use these products in dry, interior and non-corrosive environments only.

**Caution:** Oversized holes in the base material will greatly reduce the anchor's load capacity. For CSD, embedment depths greater than 1 1/2" may cause bending during installation.

1. Drill a hole in base material using a 1/4"-diameter carbide-tipped drill. Drill hole to specified embedment depth and blow clean using compressed air. (Overhead installation need not be blown clean.) Alternatively, drill hole deep enough to accommodate embedment depth and dust from drilling. Position fixture and insert split-drive anchor through fixture hole.
2. For CSD, 3/8"-diameter fixture hole is recommended for hard fixtures such as steel. For DSD, 5/16"-diameter fixture hole is recommended.
3. Drive anchor until head is flush against fixture.



**DSD**  
(duplex)

**CSD**  
(countersunk)

### Installation Sequence

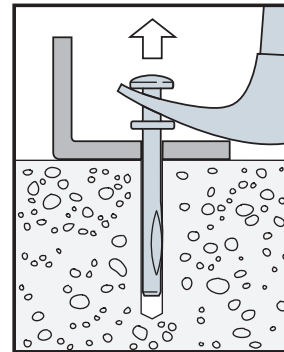
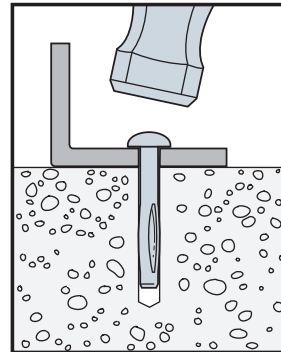
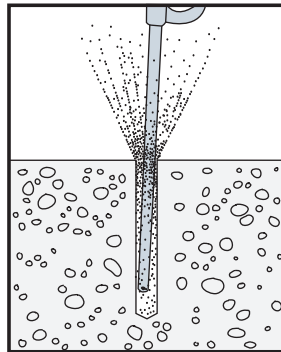
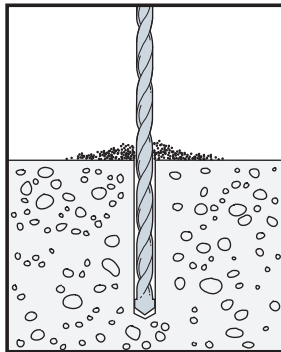

DSD anchor may be removed with a claw hammer

# CSD/DSD Split-Drive Anchors

## CSD/DSD Product Data

Size (in.)	Model No.	Head Style/Finish	Drill Bit Diameter (in.)	Quantity	
				Box	Carton
¼ x 1½	CSD25112	Countersunk head – Zinc plated	¼	100	500
¼ x 2	CSD25200			100	500
¼ x 2½	CSD25212			100	500
¼ x 3	CSD25300			100	400
¼ x 3½	CSD25312			100	400
¼ x 4	CSD25400			100	400
¼ x 3	CSD25300MG	Countersunk head – Mechanically galvanized <sup>1</sup>	¼	100	400
¼ x 4	CSD25400MG			100	400
¼ x 3	DSD25300	Duplex head – Zinc plated	¼	100	400

1. Mechanical galvanizing meets ASTM B695, Class 55, Type 1. Intended for some preservative-treated wood sill plate applications. Not for use in other corrosive or outdoor environments. See p. 261 for details.

Mechanical Anchors

## CSD Allowable Tension and Shear Loads in Normal-Weight Concrete

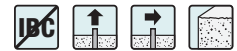

Size (in.)	Drill Bit Diameter (in.)	Embed. Depth (in.)	Minimum Spacing (in.)	Minimum Edge Distance (in.)	Tension Load (lb.)		Shear Load (lb.)	
					$f'_c \geq 2,000$ psi		$f'_c \geq 2,000$ psi	
					Ultimate Load	Allowable Load	Ultimate Load	Allowable Load
¼	¼	1¼	2½	3	655	165	970	240

## DSD Allowable Tension and Shear Loads in Normal-Weight Concrete

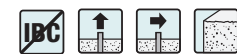

Size (in.)	Drill Bit Diameter (in.)	Embed. Depth (in.)	Minimum Spacing (in.)	Minimum Edge Distance (in.)	Concrete Compressive Strength (psi)	Tension Load (lb.)		Shear Load (lb.)	
						Ultimate Load	Allowable Load	Ultimate Load	Allowable Load
¼	¼	1¼	2½	3	2,500	800	200	2,480	620
¼	¼	1¼	2½	3	4,000	1,060	265	2,740	685

\* See p. 12 for an explanation of the load table icons.

# Sure Wall Drywall Anchor

Sure Wall anchors are self-drilling drywall anchors and provide excellent holding value and greater capacity than screws alone. This anchor cuts threads into drywall, greatly increasing the bearing surface and strength of the fastening.

## Features

- Self-drilling — may be installed in gypsum board drywall with only a screwdriver
- Easy to remove and reinstall

**Material:** Die-cast zinc or reinforced nylon



**Sure Wall Nylon**

**Sure Wall Zinc**

## Sure Wall Product Data

Screw Size	Model No.		Style	Quantity		Applications
	Packaged with Screws	Packaged Without Screws		Box	Carton	
#8 x 1 ¼	SWN08LS-R100	SWN08L-R100	Nylon	100	500	¾", ½" drywall, ceiling tile
#8 x 1 ¼	SWZ08LS-R100	SWZ08L-R100	Zinc	100	500	¾", ½", ⅜" drywall, plaster

## Sure Wall Tension and Shear Loads in ½" Drywall



Model No.	Screw Size	Allowable Loads	
		Tension (lb.)	Shear (lb.)
SWN08LS	#8	10	50
SWZ08LS	#8	10	50

1. The allowable loads are based on a safety factor of 4.0.
2. The allowable loads listed are based on single anchor tests.
3. The performance of multiple anchors spaced closely together has not been investigated.

## Installation Sequence

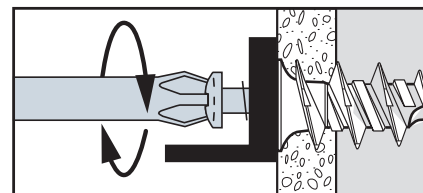
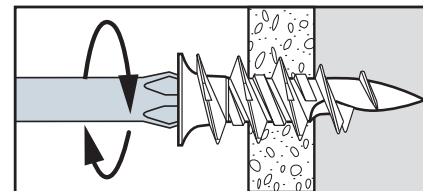
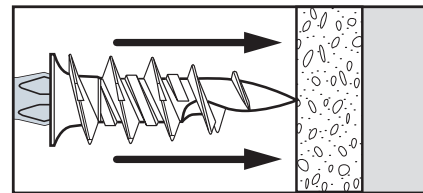

\* See p. 12 for an explanation of the load table icons.

# Direct Fastening Solutions

---





# Powder-Actuated Tool / Fastener Suitability

This matrix matches Simpson Strong-Tie powder-actuated tools with the fasteners typically used with each tool.

Fasteners		General-Purpose Tools			
		PTP-27L 	PT-27 	PT-22A-RB 	PT-22HA-RB 
<b>0.300"-Headed Fasteners with 0.157" Shank Diameter</b>					
PDPA-XXX		Max. 2½"	Max. 2½"	Max. 2½"	Max. 2½"
PDPWL-XXX		Max. 3"	3"	Max. 2½"	Max. 2½"
PDPAS-XXX					
PDPAT-XXX		✓	✓	✓	✓
PCLDPA-XXX		✓	✓	✓	✓
PECLDPA-XXX		✓	✓	✓	✓
PTRHA3-XXX		✓	✓	✓	✓
<b>0.300"-Headed Fasteners with 0.145" Shank Diameter</b>					
PINW-XXX		✓	✓	✓	✓
PINWP-XXX		3"	Max. 2½"	Max. 2½"	Max. 2½"
PHBC-XXX		✓	✓	✓	✓
PCC-XXX		✓	✓	✓	✓
PBXP-100		✓	✓	✓	✓
<b>0.250"-Headed Fasteners with 0.140" Shank Diameter</b>					
PHD-XXX					
<b>8 mm-Headed Fasteners</b>					
PKP-250		✓	✓	✓	✓
<b>⅜"-Headed Fasteners / Threaded Studs</b>					
PSLV3-XXX					

See [strongtie.com](http://strongtie.com) for more tool and fastener product information.



# Powder-Actuated Tools, Fasteners and Loads

Simpson Strong-Tie Powder Actuated Tools				
				
	<b>PTP-27L</b>	<b>PT-27</b>	<b>PT-22A</b>	<b>PT-22HA</b>
<b>Load Caliber</b>	0.27 cal strip loads	0.27 cal strip loads	0.22 cal "A" crimp	0.22 cal "A" crimp
<b>Load Power Level</b>	Brown (2) – Purple (6)	Brown (2) – Red (5)	Brown (2) – Yellow (4)	Brown (2) – Yellow (4)
<b>Firing Action</b>	Automatic	Semi-automatic	Single shot	Single shot
<b>Features</b>	Adjustable Power	Professional Grade	Economical	DIY

## PDPA Drive Pins

- Manufactured with tight tolerances for superior performance
- Code listed per ICC-ES ESR-2138; City of L.A. RR25469; Florida FL15730

All pins/loads available in 100 count boxes. See [strongtie.com](http://strongtie.com) or product guide (S-A-PG) for additional information.

0.300"-Headed Fasteners with 0.157" Shank Diameter

Length (in.)	Model No.
1/2	PDPA-50
1/2 knurled	PDPA-50K
5/8 knurled	PDPA-62K
3/4	PDPA-75
1	PDPA-100
1 1/16	PDPA-106
1 1/4	PDPA-125
1 5/16	PDPA-131
1 1/2	PDPA-150
1 7/8	PDPA-187
2	PDPA-200
2 1/2	PDPA-250
2 7/8	PDPA-287

- These models available in mechanically galvanized finish (PDPA-200MG, PDPA-250MG and PDPA-287MG).



PDPA

0.300"-Headed Fasteners with 0.157" Shank Diameter and 1" Metal Washers

Length (in.)	Model No.
1/2	PDPAWL-50
1/2 knurled	PDPAWL-50K
3/4	PDPAWL-75
1	PDPAWL-100
1 1/4	PDPAWL-125
1 1/2	PDPAWL-150
1 7/8	PDPAWL-187
2	PDPAWL-200
2 1/4	PDPAWL-225
2 1/2	PDPAWL-250
2 7/8	PDPAWL-287

- These models available in mechanically galvanized finish (PDPAWL-200MG, PDPAWL-250MG and PDPAWL-287MG).



PDPAWL

0.300"-Headed Fasteners with 0.157" Shank Diameter — 10-Pin Collation

Length (in.)	Model No.
1/2	PDPAS-50
1/2 knurled	PDPAS-50K
5/8 knurled	PDPAS-62K
3/4	PDPAS-75
1	PDPAS-100
1 1/4	PDPAS-125
1 1/2	PDPAS-150
1 7/8	PDPAS-187
2	PDPAS-200
2 1/2	PDPAS-250
2 7/8	PDPAS-287



PDPAS

0.300"-Headed Tophat Fasteners with 0.157" Shank Diameter

Length (in.)	Model No.
1/2 knurled	PDPAT-50K
5/8 knurled	PDPAT-62K
3/4	PDPAT-75
1	PDPAT-100



Point sticks for ease of hole location.

PDPAT

Pre-Assembled Ceiling Clips — 0.300"-Headed Fasteners with 0.157" Shank Diameter

Length (in.)	Model No.
7/8	PCLDPA-87
1 1/16	PCLDPA-106
1 5/16	PCLDPA-131
1 1/4	PECLDPA-106
1 5/8	PECLDPA-131



PCLDPA



PECLDPA

# Powder-Actuated Tools, Fasteners and Loads

Direct Fastening Solutions

Threaded Rod Hangers  
— 0.300"-Headed  
Fasteners with  
0.157" Shank Diameter

Length (in.)	Model No.
1 5/16, 1/4 – 20 threaded rod hanger	PTRHA4-131
1 5/16, 3/8 – 16 threaded rod hanger	PTRHA3-131



0.300"-Headed  
Fasteners with 0.145"  
Shank Diameter and  
1 7/16" Metal Washers

Length (in.)	Model No.
1 1/2	PINW-150
2	PINW-200
2 1/2	PINW-250
3	PINW-300



0.300"-Headed Fasteners  
with 0.145" Shank  
Diameter and 1 3/8"  
Plastic White Washers

Length (in.)	Model No.
1	PINWP-100W
1 1/2	PINWP-150W
1 3/4	PINWP-175W
2	PINWP-200W
2 1/2	PINWP-250W
3	PINWP-300W

These models available with inverted plastic washer (PINWP-150MF and PINWP-250MF).



Highway Basket Clips  
— 0.300"-Headed  
Fasteners with  
0.145" Shank Diameter

Description	Model No.
Clip with 1 1/2" pin	PHBC-150
Clip with 2" pin	PHBC-200
Clip with 2 1/2" pin	PHBC-250



Pre-Assembled BX  
Cable Straps and  
Conduit Straps —  
0.300"-Headed  
Fasteners with 0.145"  
Shank Diameter

Description	Model No.
BX cable strap with 1" pin	PBXDP-100
Conduit clip 1/2" EMT with 1" pin	PCC50-DP100
Conduit clip 3/4" EMT with 1" pin	PCC75-DP100
Conduit clip 1" EMT with 1" pin	PCC100-DP100



3/8" — 16 Threaded Studs\*

Length (in.)	Model No.
3/8 – 16 knurled (T-1 1/4, S-3/4)	PSLV3-12575K
3/8 – 16 (T-1 1/4, S-1)	PSLV3-125100
3/8 – 16 (T-1 1/4, S-1 1/4)	PSLV3-125125

\*Shank diameter is 0.205".  
Note: T = thread length,  
S = shank length.



Concrete Forming Pin —  
0.187"-Headed with  
0.145" Shank Diameter

Length (in.)	Model No.
3/16 x 2 1/2 concrete forming pin	PKP-250

**Note:** Lengths in inches are for reference only and may not be exact.



1/4"-Headed Hammer  
Drive Fastener with  
3/8" Metal Washer

Length (in.)	Model No.
3/4	PHD-75
1	PHD-100
1 1/4	PHD-125



**PHT-38**  
Manual Hammer Tool  
*(not for use with powder loads)*



**Warning:** Do not use powder loads with this tool. This is a hammer drive tool only. Use of powder loads with this tool may result in injury or death.

# Powder-Actuated Tools, Fasteners and Loads

## 0.22-Caliber "A" Crimp Loads — Single Shot

Description	Model No.
0.22 cal. — Brown (Level 2)	P22AC2
	P22AC2A
0.22 cal. — Green (Level 3)	P22AC3
	P22AC3A
0.22 cal. — Yellow (Level 4)	P22AC4
	P22AC4A

**Note:** An "A" in a part number denotes imported load.  
No "A" indicates a domestic load.



P22AC

## 0.27-Caliber Single-Shot Loads — Long

Description	Model No.
0.27 cal. — Yellow (Level 4)	P27LVL4
0.27 cal. — Red (Level 5)	P27LVL5
0.27 cal. — Purple (Level 6)	P27LVL6



P27LVL

## 0.27-Caliber Plastic, 10-Shot Strip Loads

Description	Model No.
0.27 cal. — Brown (Level 2)	P27SL2
	P27SL2A
0.27 cal. — Green (Level 3)	P27SL3
	P27SL3A
0.27 cal. — Yellow (Level 4)	P27SL4
	P27SL4A
0.27 cal. — Red (Level 5)	P27SL5
	P27SL5A
0.27 cal. — Purple (Level 6)	P27SL6

**Note:** An "A" in a part number denotes imported load.  
No "A" indicates a domestic load.



P27SL







## 0.25-Caliber Plastic 10-Shot Strip Loads

Description	Model No.
0.25 cal. — Green (Level 3)	P25SL3
0.25 cal. — Yellow (Level 4)	P25SL4
0.25 cal. — Red (Level 5)	P25SL5



P25SL

# Gas Tool / Fastener Suitability

<p>Gas Tool GCN-MEP</p>																										
<p>Fuel Cell GFCXX</p>																										
<p>0.106"-Diameter Shank Pins GDP US Patent 605,016</p>	<table border="1"> <thead> <tr> <th>Model No.</th> <th>Length (in.)</th> </tr> </thead> <tbody> <tr> <td>GDP-50KT</td> <td>1/2</td> </tr> <tr> <td>GDP-62KT</td> <td>5/8</td> </tr> <tr> <td>GDP-75KT</td> <td>3/4</td> </tr> <tr> <td>GDP-100KT</td> <td>1</td> </tr> <tr> <td>GDP-125KT</td> <td>1 1/4</td> </tr> <tr> <td>GDP-150KT</td> <td>1 1/2</td> </tr> </tbody> </table>	Model No.	Length (in.)	GDP-50KT	1/2	GDP-62KT	5/8	GDP-75KT	3/4	GDP-100KT	1	GDP-125KT	1 1/4	GDP-150KT	1 1/2											
Model No.	Length (in.)																									
GDP-50KT	1/2																									
GDP-62KT	5/8																									
GDP-75KT	3/4																									
GDP-100KT	1																									
GDP-125KT	1 1/4																									
GDP-150KT	1 1/2																									
<p>0.118"- / 0.102"-Diameter Stepped-Shank Pins GDPS</p>	<table border="1"> <thead> <tr> <th>Model No.</th> <th>Length (in.)</th> </tr> </thead> <tbody> <tr> <td>GDPS-50KT</td> <td>1/2</td> </tr> <tr> <td>GDPS-62KT</td> <td>5/8</td> </tr> <tr> <td>GDPS-75KT</td> <td>3/4</td> </tr> </tbody> </table>	Model No.	Length (in.)	GDPS-50KT	1/2	GDPS-62KT	5/8	GDPS-75KT	3/4																	
Model No.	Length (in.)																									
GDPS-50KT	1/2																									
GDPS-62KT	5/8																									
GDPS-75KT	3/4																									
<p>Spiral Knurl Pins GDPSK</p>	<table border="1"> <thead> <tr> <th>Model No.</th> <th>Length (in.)</th> </tr> </thead> <tbody> <tr> <td>GDPSK-138KT</td> <td>1 3/8</td> </tr> </tbody> </table>	Model No.	Length (in.)	GDPSK-138KT	1 3/8																					
Model No.	Length (in.)																									
GDPSK-138KT	1 3/8																									
<p>Mechanical Electrical Plumbing Pins</p>	<table border="1"> <thead> <tr> <th>Model No.</th> <th>Description</th> </tr> </thead> <tbody> <tr> <td>GCC50-R100</td> <td>1/2" conduit clip with pin</td> </tr> <tr> <td>GCC75-R100</td> <td>3/4" conduit clip with pin</td> </tr> <tr> <td>GCC100-R100</td> <td>1" conduit clip with pin</td> </tr> <tr> <td>GCC125-R50</td> <td>1" conduit clip (13-gauge steel) with pin</td> </tr> <tr> <td>GAC-R100</td> <td>Angle clip with pin</td> </tr> <tr> <td>GCT-R50</td> <td>Tie-strap holder with pin</td> </tr> <tr> <td>GW50-R200</td> <td>1/2" dome washer x 1/2" step-shank (0.110"/0.128") pin</td> </tr> <tr> <td>GW75-R200</td> <td>1/2" dome washer with 0.125" x 3/4" pin</td> </tr> <tr> <td>GW100-R100</td> <td>1/2" dome washer with pin</td> </tr> <tr> <td>GTS4-5075-R200</td> <td>1/4" threaded stud, 1/2" length 1/4-20 thread, 3/4" length shank (0.127" diameter)</td> </tr> <tr> <td>GTH-R200</td> <td>Tophat pin</td> </tr> </tbody> </table>	Model No.	Description	GCC50-R100	1/2" conduit clip with pin	GCC75-R100	3/4" conduit clip with pin	GCC100-R100	1" conduit clip with pin	GCC125-R50	1" conduit clip (13-gauge steel) with pin	GAC-R100	Angle clip with pin	GCT-R50	Tie-strap holder with pin	GW50-R200	1/2" dome washer x 1/2" step-shank (0.110"/0.128") pin	GW75-R200	1/2" dome washer with 0.125" x 3/4" pin	GW100-R100	1/2" dome washer with pin	GTS4-5075-R200	1/4" threaded stud, 1/2" length 1/4-20 thread, 3/4" length shank (0.127" diameter)	GTH-R200	Tophat pin	
Model No.	Description																									
GCC50-R100	1/2" conduit clip with pin																									
GCC75-R100	3/4" conduit clip with pin																									
GCC100-R100	1" conduit clip with pin																									
GCC125-R50	1" conduit clip (13-gauge steel) with pin																									
GAC-R100	Angle clip with pin																									
GCT-R50	Tie-strap holder with pin																									
GW50-R200	1/2" dome washer x 1/2" step-shank (0.110"/0.128") pin																									
GW75-R200	1/2" dome washer with 0.125" x 3/4" pin																									
GW100-R100	1/2" dome washer with pin																									
GTS4-5075-R200	1/4" threaded stud, 1/2" length 1/4-20 thread, 3/4" length shank (0.127" diameter)																									
GTH-R200	Tophat pin																									

See product guide (S-A-PG) and [strongtie.com](http://strongtie.com) for additional information.

## Gas- and Powder-Actuated Fasteners Design Information – Concrete

Powder-Actuated and Gas-Actuated Fasteners –  
Allowable Tension Loads in Normal-Weight Concrete

Direct Fastening Type	Model No.	Shank Diameter in. (mm)	Minimum Penetration in. (mm)	Minimum Edge Distance in. (mm)	Minimum Spacing in. (mm)	Allowable Tension Load — lb. (kN)				
						f <sub>c</sub> = 2,500 psi (17.2 MPa)	f <sub>c</sub> = 3,000 psi (20.7 MPa)	f <sub>c</sub> = 4,000 psi (27.6 MPa)	f <sub>c</sub> = 5,000 psi (34.5 MPa)	f <sub>c</sub> = 6,000 psi (41.3 MPa)
Powder Actuated	PDPAT PDPAT PDPAT	0.157 (4.0)	3/4 (19)	3.5 (89)	5 (127)	110 (0.49)	110 (0.49)	110 (0.49)	—	110 (0.49)
			1 (25)	3.5 (89)	5 (127)	210 (0.93)	240 (1.07)	310 (1.38)	—	160 (0.71)
			1 1/4 (32)	3.5 (89)	5 (127)	320 (1.42)	340 (1.51)	380 (1.69)	—	365 (1.62)
			1 1/2 (38)	3.5 (89)	5 (127)	375 (1.67)	400 (1.78)	450 (2.00)	—	465 (2.07)
	PINW PINWP	0.145 (3.7)	1 (25)	3 (76)	4 (102)	70 (0.31)	100 (0.44)	150 (0.67)	—	150 (0.67)
			1 1/4 (32)	3 (76)	4 (102)	195 (0.87)	255 (1.13)	370 (1.65)	—	370 (1.65)
	PSLV3	0.205 (5.2)	1 1/4 (32)	4 (102)	6 (152)	260 (1.16)	—	—	—	—
Gas Actuated	GDP	0.106 (2.7)	5/8 (16)	3 (76)	4 (102)	25 (0.11)	30 (0.13)	45 (0.20)	45 (0.20)	—
			3/4 (19)	3 (76)	4 (102)	30 (0.13)	30 (0.13)	30 (0.13)	30 (0.13)	—
	GW-75 GW-100 GTH	0.125 (3.2)	5/8 (16)	3 (76)	4 (102)	65 (0.29)	70 (0.31)	95 (0.42)	—	—
			3/4 (19)	3 (76)	4 (102)	95 (0.42)	105 (0.47)	190 (0.85)	—	—

1. The fasteners must not be driven until the concrete has reached the designated minimum compressive strength.
2. Minimum concrete thickness must be three times the fastener embedment into the concrete.
3. The allowable tension values are only for the fastener in the concrete. Members connected to the concrete must be investigated in accordance with accepted design criteria.
4. The allowable load values listed are for static load conditions. Refer to ICC-ES ESR-2138 and ESR-2811 code reports for seismic load conditions.
5. For fastener installation in concrete with compressive strength outside of the listed range, published allowable loads shall not be extrapolated.

Powder-Actuated and Gas-Actuated Fasteners –  
Allowable Shear Loads in Normal-Weight Concrete

Direct Fastening Type	Model No.	Shank Diameter in. (mm)	Minimum Penetration in. (mm)	Minimum Edge Distance in. (mm)	Minimum Spacing in. (mm)	Allowable Shear Load — lb. (kN)				
						f <sub>c</sub> = 2,500 psi (17.2 MPa)	f <sub>c</sub> = 3,000 psi (20.7 MPa)	f <sub>c</sub> = 4,000 psi (27.6 MPa)	f <sub>c</sub> = 5,000 psi (34.5 MPa)	f <sub>c</sub> = 6,000 psi (41.3 MPa)
Powder Actuated	PDPAT PDPAT PDPAT	0.157 (4.0)	3/4 (19)	3.5 (89)	5 (127)	120 (0.53)	125 (0.56)	135 (0.60)	—	130 (0.58)
			1 (25)	3.5 (89)	5 (127)	285 (1.27)	290 (1.29)	310 (1.38)	—	350 (1.56)
			1 1/4 (32)	3.5 (89)	5 (127)	360 (1.60)	380 (1.69)	420 (1.87)	—	390 (1.73)
			1 1/2 (38)	3.5 (89)	5 (127)	405 (1.80)	430 (1.91)	485 (2.16)	—	495 (2.20)
	PINW PINWP	0.145 (3.7)	1 (25)	3 (76)	4 (102)	140 (0.62)	165 (0.73)	205 (0.91)	—	205 (0.91)
			1 1/4 (32)	3 (76)	4 (102)	265 (1.18)	265 (1.18)	265 (1.18)	—	265 (1.18)
Gas Actuated	GDP	0.106 (2.7)	5/8 (16)	3 (76)	4 (102)	25 (0.11)	25 (0.11)	25 (0.11)	25 (0.11)	—
			3/4 (19)	3 (76)	4 (102)	50 (0.22)	55 (0.24)	75 (0.33)	75 (0.33)	—
	GW-75 GW-100 GTH	0.125 (3.2)	5/8 (16)	3 (76)	4 (102)	60 (0.27)	65 (0.29)	95 (0.42)	—	—
			3/4 (19)	3 (76)	4 (102)	135 (0.60)	145 (0.64)	215 (0.96)	—	—

1. The fasteners must not be driven until the concrete has reached the designated minimum compressive strength.
2. Minimum concrete thickness must be three times the fastener embedment into the concrete.
3. The allowable shear values are only for the fastener in the concrete. Members connected to the concrete must be investigated in accordance with accepted design criteria.
4. The allowable load values listed are for static load conditions. Refer to ICC-ES ESR-2138 and ESR-2811 code reports for seismic load conditions.
5. For fastener installation in concrete with compressive strength outside of the listed range, published allowable loads shall not be extrapolated.

\* See p. 12 for an explanation of the load table icons.

## Gas- and Powder-Actuated Fasteners Design Information – Concrete

Powder-Actuated and Gas-Actuated Assemblies —  
Allowable Tension Loads in Normal-Weight Concrete

Direct Fastening Type	Model No.	Shank Diameter in. (mm)	Minimum Penetration in. (mm)	Minimum Edge Distance in. (mm)	Minimum Spacing in. (mm)	Allowable Tension Load — lb. (kN)				
						f <sub>c</sub> = 2,500 psi (17.2 MPa)	f <sub>c</sub> = 3,000 psi (20.7 MPa)	f <sub>c</sub> = 4,000 psi (27.6 MPa)	f <sub>c</sub> = 5,000 psi (34.5 MPa)	f <sub>c</sub> = 6,000 psi (41.3 MPa)
Powder Actuated	PCLDPA	0.157 (4.0)	¾ (19)	3.5 (89)	5 (102)	70 (0.31)	—	120 (0.53)	—	130 (0.58)
			1 (25)	3.5 (89)	5 (102)	175 (0.78)	—	180 (0.80)	—	190 (0.85)
			1¼ (32)	3.5 (89)	5 (102)	210 (0.93)	—	210 (0.93)	—	190 (0.85)
	PECLDPA	0.157 (4.0)	7/8 (22)	3.5 (89)	5 (102)	90 (0.40)	—	110 (0.49)	—	85 (0.38)
			1 (25)	3.5 (89)	5 (102)	180 (0.80)	—	155 (0.69)	—	180 (0.80)
	PTRHA3 PTRHA4	0.157 (4.0)	1¼ (32)	3.5 (89)	5 (102)	185 (0.82)	—	220 (0.98)	—	190 (0.85)
Gas Actuated	GAC	0.125 (3.2)	¾ (19)	3 (76)	4 (102)	105 (0.47)	120 (0.53)	150 (0.67)	170 (0.76)	195 (0.87)

- The fasteners must not be driven until the concrete has reached the designated minimum compressive strength.
- Minimum concrete thickness must be three times the fastener embedment into the concrete.
- The allowable tension values are only for the fastener in the concrete. Members connected to the concrete must be investigated in accordance with accepted design criteria.
- The allowable load values listed are for static load conditions. Refer to ICC-ES ESR-2138 and ESR-2811 code reports for seismic load conditions.
- For fastener installation in concrete with compressive strength outside of the listed range, published allowable loads shall not be extrapolated.

Powder-Actuated and Gas-Actuated Assemblies —  
Allowable Oblique Loads in Normal-Weight Concrete

Direct Fastening Type	Model No.	Shank Diameter in. (mm)	Minimum Penetration in. (mm)	Minimum Edge Distance in. (mm)	Minimum Spacing in. (mm)	Allowable Oblique Load — lb. (kN)				
						f <sub>c</sub> = 2,500 psi (17.2 MPa)	f <sub>c</sub> = 3,000 psi (20.7 MPa)	f <sub>c</sub> = 4,000 psi (27.6 MPa)	f <sub>c</sub> = 5,000 psi (34.5 MPa)	f <sub>c</sub> = 6,000 psi (41.3 MPa)
Powder Actuated	PCLDPA	0.157 (4.0)	¾ (19)	3.5 (89)	5 (102)	115 (0.51)	—	105 (0.47)	—	140 (0.62)
			1 (25)	3.5 (89)	5 (102)	255 (1.13)	—	240 (1.07)	—	245 (1.09)
			1¼ (32)	3.5 (89)	5 (102)	250 (1.11)	—	265 (1.18)	—	265 (1.18)
	PECLDPA	0.157 (4.0)	7/8 (22)	3.5 (89)	5 (102)	135 (0.60)	—	130 (0.58)	—	115 (0.51)
			1 (25)	3.5 (89)	5 (102)	225 (1.00)	—	230 (1.02)	—	255 (1.13)
	Gas Actuated	GAC	0.125 (3.2)	¾ (19)	3 (76)	4 (102)	130 (0.58)	135 (0.60)	145 (0.64)	155 (0.69)

- The fasteners must not be driven until the concrete has reached the designated minimum compressive strength.
- Minimum concrete thickness must be three times the fastener embedment into the concrete.
- The allowable oblique values are only for the fastener in the concrete. Members connected to the concrete must be investigated in accordance with accepted design criteria.
- Oblique load direction is 45° from the concrete member surface.
- The allowable load values listed are for static load conditions. Refer to ICC-ES ESR-2138 and ESR-2811 code reports for seismic load conditions.
- For fastener installation in concrete with compressive strength outside of the listed range, published allowable loads shall not be extrapolated.

\* See p. 12 for an explanation of the load table icons.

## Gas- and Powder-Actuated Fasteners Design Information – Concrete

Powder-Actuated Fasteners — Allowable Tension and Shear Loads  
for Attachment of Wood Sill Plates to Normal-Weight Concrete

Direct Fastening Type	Model No.	Overall Length in. (mm)	Nominal Head Diameter in. (mm)	Shank Diameter in. (mm)	Washer Thickness in. (mm)	Washer Bearing Area in. <sup>2</sup> (mm <sup>2</sup> )	f' <sub>c</sub> = 2,500 psi (17.2 MPa)	
							Allowable Tension Load lb. (kN)	Allowable Shear Load lb. (kN)
Powder Actuated	PDPAWL-287 PDPAWL-287MG	2 <sup>7</sup> / <sub>8</sub> (73)	0.300 (7.6)	0.157 (4.0)	0.070 (1.8)	0.767 (495)	200 (0.89)	205 (0.91)

1. The fasteners must not be driven until the concrete has reached the designated minimum compressive strength.
2. Minimum concrete thickness must be three times the fastener embedment into the concrete.
3. The allowable tension and shear values are only for the fastener in the concrete. Members connected to the concrete must be investigated in accordance with accepted design criteria.
4. Minimum concrete edge distance is 1<sup>3</sup>/<sub>4</sub>".
5. Only mechanically galvanized fasteners may be used to attach preservative-treated wood to concrete.
6. Minimum spacing shall be 4" on center.
7. The allowable load values listed are for static load conditions. Refer to ICC-ES ESR-2138 code report for seismic load conditions.

Spacing of Powder-Actuated Fasteners  
for Attachment of Wood Sill Plates to Normal-Weight Concrete

Direct Fastening Type	Model No.	Overall Length in. (mm)	Nominal Head Diameter in. (mm)	Shank Diameter in. (mm)	Maximum Spacing in. (mm)
					Interior Nonstructural Walls <sup>2</sup>
Powder Actuated	PDPAWL-287 <sup>3</sup> PDPAWL-287MG <sup>3</sup>	2 <sup>7</sup> / <sub>8</sub> (73)	0.300 (7.6)	0.157 (4.0)	48 (1,219)

1. Spacings are based upon the attachment of 2" (nominal thickness) wood sill plates, with specific gravity of 0.50 or greater, to concrete floor slabs or footings.
2. All walls shall have fasteners placed at 6" from ends of sill plates, with maximum spacing as shown in the table.
3. Fasteners shall not be driven until the concrete has reached a compressive strength of 2,500 psi. Minimum edge distance is 1<sup>3</sup>/<sub>4</sub>".
4. The maximum horizontal transverse load on the wall shall be 5 psf.
5. The maximum wall height shall be 14 feet.
6. For exterior walls and interior structural walls, this table is not applicable and allowable loads must be used.
7. Walls shall be laterally supported at the top and the bottom.
8. Minimum spacing shall be 4" on center.
9. Only mechanically galvanized fasteners may be used to attach preservative-treated wood to concrete.

## Gas- and Powder-Actuated Fasteners Design Information – Concrete

Powder-Actuated and Gas-Actuated Fasteners –  
Allowable Tension Loads in Sand-Lightweight Concrete over Steel Deck

Direct Fastening Type	Model No.	Shank Diameter in. (mm)	Minimum Penetration in. (mm)	Allowable Tension Load — lb. (kN)				
				Installed in Concrete <sup>4</sup>	Installed Thru. 3" "W" Deck with 3 1/4" Concrete Fill <sup>5</sup>	Installed Thru. 3" "W" Deck with 2 1/4" Concrete Fill <sup>6</sup>	Installed Thru. 1.5" "B" Deck with 2 1/4" Concrete Fill <sup>7</sup>	Installed Thru. 1.5" "B" Deck with 2" Concrete Fill <sup>8</sup>
				$f'_c = 3,000$ psi (20.7 MPa) Concrete				
Powder Actuated	PDDPA PDPAT PDDPAWL	0.157 (4.0)	3/4 (19)	85 (0.38)	105 (0.47)	—	—	160 (0.71)
			1 (25)	150 (0.67)	145 (0.64)	—	—	210 (0.93)
			1 1/4 (32)	320 (1.42)	170 (0.76)	—	—	265 (1.18)
			1 1/2 (38)	385 (1.71)	325 (1.45)	—	—	—
	PINW PINWP	0.145 (3.7)	7/8 (22)	85 (0.38)	40 (0.18)	—	—	—
	PSLV3	0.205 (5.2)	1 1/4 (32)	—	225 (1.00)	—	—	—
Gas Actuated	GDP	0.106 (2.7)	5/8 (16)	75 (0.33)	—	60 (0.27)	65 (0.29)	—
			3/4 (19)	105 (0.47)	—	60 (0.27)	130 (0.58)	—
	GW-75 GW-100 GTH	0.125 (3.2)	5/8 (16)	60 (0.27)	—	35 (0.16)	—	—
			3/4 (19)	115 (0.51)	—	55 (0.24)	—	—

- The fastener shall not be driven until the concrete has reached the designated compressive strength.
- The allowable tension values are for the fastener only. Members connected to the concrete must be investigated separately in accordance with accepted design criteria.
- Steel deck must be minimum 20 gauge and have a minimum yield strength of 38,000 psi.
- The minimum fastener spacing is 4". The minimum edge distances are 3 1/2" and 3" for powder-actuated fasteners and gas-actuated fasteners, respectively.
- The fastener shall be installed minimum 1 1/2" from the edge of flute and 4" from the end of the deck. The minimum fastener spacing is 4".
- The fastener shall be installed minimum 1" from the edge of flute and 3" from the end of the deck. The minimum fastener spacing is 4". For GW and GTH fasteners, the fastener must be a minimum of 1 1/8" from the edge of flute.
- The fastener shall be installed minimum 7/8" from the edge of flute. For inverted 1.5" "B" deck configuration, the fastener must be a minimum of 1" from the edge of flute. Fastener must be installed minimum 3" from the end of the deck. The minimum fastener spacing is 4".
- The fastener shall be installed minimum 7/8" from the edge of flute and 4" from the end of the deck. The minimum fastener spacing is 4".
- The allowable load values listed are for static load conditions. Refer to ICC-ES ESR-2138 and ESR-2811 code reports for seismic load conditions.

\* See p. 12 for an explanation of the load table icons.



# Gas- and Powder-Actuated Fasteners Design Information – Concrete

Powder-Actuated and Gas-Actuated Fasteners —  
Allowable Shear Loads in Sand-Lightweight Concrete over Steel Deck



Direct Fastening Type	Model No.	Shank Diameter in. (mm)	Minimum Penetration in. (mm)	Allowable Shear Load — lb. (kN)				
				Installed in Concrete <sup>9</sup>	Installed Thru. 3" "W" Deck with 3 1/4" Concrete Fill <sup>5</sup>	Installed Thru. 3" "W" Deck with 2 1/4" Concrete Fill <sup>6</sup>	Installed Thru. 1.5" "B" Deck with 2 1/4" Concrete Fill <sup>7</sup>	Installed Thru. 1.5" "B" Deck with 2" Concrete Fill <sup>8</sup>
				f'c = 3,000 psi (20.7 MPa) Concrete				
Powder Actuated	PDPA PDPAT PDPAWL	0.157 (4.0)	3/4 (19)	105 (0.47)	280 (1.25)	—	—	275 (1.22)
			1 (25)	225 (1.00)	280 (1.25)	—	—	370 (1.65)
			1 1/4 (32)	420 (1.87)	320 (1.42)	—	—	460 (2.05)
			1 1/2 (38)	455 (2.02)	520 (2.31)	—	—	—
	PINW PINWP	0.145 (3.7)	7/8 (22)	250 (1.11)	275 (1.22)	—	—	—
Gas Actuated	GDP	0.106 (2.7)	5/8 (16)	35 (0.16)	—	180 (0.80)	195 (0.87)	—
			3/4 (19)	140 (0.62)	—	180 (0.80)	270 (1.20)	—
	GW-75 GW-100 GTH	0.125 (3.2)	5/8 (16)	110 (0.49)	—	215 (0.96)	—	—
			3/4 (19)	130 (0.58)	—	235 (1.05)	—	—

1. The fastener shall not be driven until the concrete has reached the designated compressive strength.
2. The allowable shear values are for the fastener only. Members connected to the concrete must be investigated separately in accordance with accepted design criteria.
3. Steel deck must be minimum 20 gauge and have a minimum yield strength of 38,000 psi.
4. Shear values are for loads applied toward edge of flute.
5. The fastener shall be installed minimum 1 1/2" from the edge of flute and 4" from the end of the deck. The minimum fastener spacing is 4".
6. The fastener shall be installed minimum 1" from the edge of flute and 3" from the end of the deck. The minimum fastener spacing is 4". For GW and GTH fasteners, the fastener must be a minimum of 1 1/8" from the edge of flute.
7. The fastener shall be installed minimum 7/8" from the edge of flute. For inverted 1.5" "B" deck configuration, the fastener must be a minimum of 1" from the edge of flute. Fastener must be installed minimum 3" from the end of the deck. The minimum fastener spacing is 4".
8. The fastener shall be installed minimum 7/8" from the edge of flute and 4" from the end of the deck. The minimum fastener spacing is 4".
9. The minimum fastener spacing is 4". The minimum edge distances are 3 1/2" and 3" for powder-actuated fasteners and gas-actuated fasteners, respectively.
10. The allowable load values listed are for static load conditions. Refer to ICC-ES ESR-2138 and ESR-2811 code reports for seismic load conditions.

C-A-2021 © 2021 SIMPSON STRONG-TIE COMPANY INC.

Direct Fastening Solutions

\* See p. 12 for an explanation of the load table icons.

## Gas- and Powder-Actuated Fasteners Design Information – Concrete

Powder-Actuated and Gas-Actuated Assemblies –  
Allowable Tension Loads in Sand-Lightweight Concrete over Steel Deck

Direct Fastening Type	Model No.	Shank Diameter in. (mm)	Minimum Penetration in. (mm)	Allowable Tension Load — lb. (kN)			
				Installed Thru. 3" "W" Deck with 2 1/2" Concrete Fill <sup>4</sup>	Installed Thru. 3" "W" Deck with 2 1/4" Concrete Fill <sup>5</sup>	Installed Thru. 1.5" "B" Deck with 2 1/4" Concrete Fill <sup>6</sup>	Installed Thru. 1.5" "B" Deck with 2" Concrete Fill <sup>7</sup>
				f <sub>c</sub> = 3,000 psi (20.7 MPa) Concrete			
Powder Actuated	PTRHA3 PTRHA4	0.157 (4.0)	1 1/4 (32)	160 (0.71)	—	—	175 (0.78)
	PCLDPA	0.157 (4.0)	3/4 (19)	115 (0.51)	—	—	60 (0.27)
			1 (25)	140 (0.62)	—	—	160 (0.71)
			1 1/4 (32)	160 (0.71)	—	—	180 (0.80)
	PECDLPA	0.157 (4.0)	7/8 (22)	80 (0.36)	—	—	95 (0.40)
			1 (25)	120 (0.53)	—	—	135 (0.60)
Gas Actuated	GAC	0.125 (3.2)	3/4 (19)	—	105 (0.47)	90 (0.40)	—

- The fastener shall not be driven until the concrete has reached the designated compressive strength.
- The allowable tension values are for the fastener only. Members connected to the concrete must be investigated separately in accordance with accepted design criteria.
- Steel deck must be minimum 20 gauge and have a minimum yield strength of 38,000 psi.
- The fastener shall be installed minimum 1 1/2" from the edge of flute and 4" from the end of the deck. The minimum fastener spacing is 4".
- The fastener shall be installed minimum 1" from the edge of flute and 3" from the end of the deck. The minimum fastener spacing is 4".
- The fastener shall be installed minimum 7/8" from the edge of flute and 3" from the end of the deck. The minimum fastener spacing is 4".
- The fastener shall be installed minimum 7/8" from the edge of flute and 4" from the end of the deck. The minimum fastener spacing is 4".
- The allowable load values listed are for static load conditions. Refer to ICC-ES ESR-2138 and ESR-2811 code reports for seismic load conditions.

Powder-Actuated and Gas-Actuated Assemblies –  
Allowable Oblique Loads in Sand-Lightweight Concrete over Steel Deck

Direct Fastening Type	Model No.	Shank Diameter in. (mm)	Minimum Penetration in. (mm)	Allowable Oblique Load — lb. (kN)			
				Installed Thru. 3" "W" Deck with 2 1/2" Concrete Fill <sup>4</sup>	Installed Thru. 3" "W" Deck with 2 1/4" Concrete Fill <sup>5</sup>	Installed Thru. 1.5" "B" Deck with 2 1/4" Concrete Fill <sup>6</sup>	Installed Thru. 1.5" "B" Deck with 2" Concrete Fill <sup>7</sup>
				f <sub>c</sub> = 3,000 psi (20.7 MPa) Concrete			
Powder Actuated	PCLDPA	0.157 (4.0)	3/4 (19)	155 (0.69)	—	—	175 (0.78)
			1 (25)	175 (0.78)	—	—	240 (1.07)
			1 1/4 (32)	185 (0.82)	—	—	280 (1.25)
	PECDLPA	0.157 (4.0)	7/8 (22)	110 (0.49)	—	—	110 (0.49)
			1 (25)	145 (0.64)	—	—	175 (0.78)
	Gas Actuated	GAC	0.125 (3.2)	3/4 (19)	—	120 (0.53)	90 (0.40)

- The fastener shall not be driven until the concrete has reached the designated compressive strength.
- The allowable oblique values are for the fastener only. Members connected to the concrete must be investigated separately in accordance with accepted design criteria.
- Steel deck must be minimum 20 gauge and have a minimum yield strength of 38,000 psi.
- The fastener shall be installed minimum 1 1/2" from the edge of flute and 4" from the end of the deck. The minimum fastener spacing is 4".
- The fastener shall be installed minimum 1" from the edge of flute and 3" from the end of the deck. The minimum fastener spacing is 4".
- The fastener shall be installed minimum 7/8" from the edge of flute and 3" from the end of the deck. The minimum fastener spacing is 4".
- The fastener shall be installed minimum 7/8" from the edge of flute and 4" from the end of the deck. The minimum fastener spacing is 4".
- Oblique load direction is 45° from the concrete member surface.
- The allowable load values listed are for static load conditions. Refer to ICC-ES ESR-2138 and ESR-2811 code reports for seismic load conditions.

\* See p. 12 for an explanation of the load table icons.

# Gas- and Powder-Actuated Fasteners Design Information – CMU

Powder-Actuated and Gas-Actuated Fasteners – Allowable Tension and Shear Loads in Hollow and Grout-Filled CMU<sup>4,5,8</sup>



Direct Fastening Type	Model No.	Shank Diameter in. (mm)	Minimum Penetration in. (mm)	Minimum Edge Distance in. (mm)	8-inch Hollow CMU		8-inch Grout-Filled CMU	
					Tension Load	Shear Load	Tension Load	Shear Load
					Allowable lb. (kN)	Allowable lb. (kN)	Allowable lb. (kN)	Allowable lb. (kN)
Powder Actuated	PDPA PDPAT PDPAWL	0.157 (4.0)	1¾ (44)	3½ (89)	125 <sup>1</sup> (0.56)	210 <sup>1</sup> (0.93)	190 <sup>3</sup> (0.85)	245 <sup>3</sup> (1.09)
	PINW PINWP	0.145 (3.7)	1¾ (44)	3½ (89)	110 <sup>1</sup> (0.49)	200 <sup>1</sup> (0.89)	—	—
Gas Actuated	GDP	0.106 (2.7)	5⁄8 (16)	3 (76)	35 <sup>1</sup> (0.16)	60 <sup>1</sup> (0.27)	—	—
	GW-75 GW-100 GTH	0.125 (3.2)	5⁄8 (16)	3 (76)	75 <sup>2</sup> (0.33)	90 <sup>2</sup> (0.40)	—	—

1. Allowable values for fasteners in hollow lightweight concrete masonry units conforming to ASTM C90.
2. Allowable values for fasteners in hollow medium-weight concrete masonry units conforming to ASTM C90.
3. Allowable values for fasteners in grout-filled lightweight concrete masonry units conforming to ASTM C90 with coarse grout conforming to ASTM C746.
4. The minimum allowable nominal size of the CMU must be 8" high by 8" wider by 16" long, with a minimum 1¼"-thick face shell thickness.
5. Allowable values are for fasteners installed in the center of a CMU face shell. See Figure 1 for the applicable placement zone.
6. Minimum penetration is measured from the outside face of the CMU.
7. Allowable values are for the fastener only. Members connected to the CMU must be investigated separately in accordance with accepted design criteria.
8. The allowable load values listed are for static load conditions. Refer to ICC-ES ESR-2138 and ESR-2811 code reports for seismic load conditions.

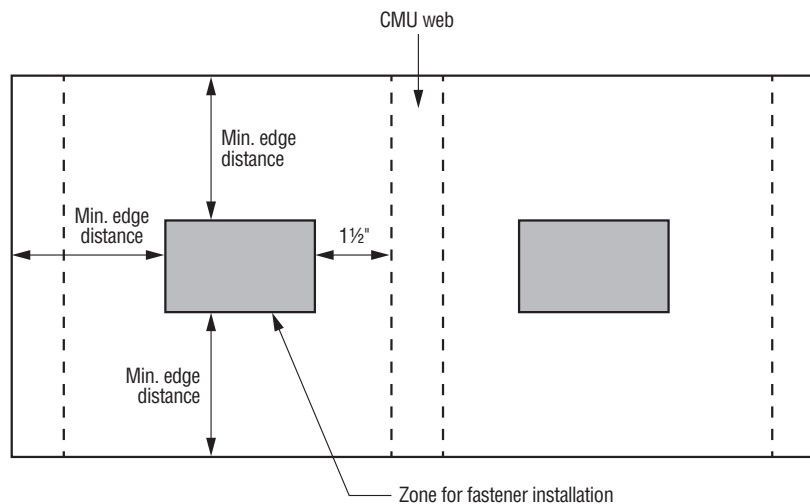

Figure 1. Zone for Fastener Installation in Face Shell of CMU

\* See p. 12 for an explanation of the load table icons.

# Gas- and Powder-Actuated Fasteners Design Information – Steel

Powder-Actuated and Gas-Actuated Fasteners —  
Allowable Tension Loads in Steel<sup>1</sup>



Direct Fastening Type	Model No.	Shank Diameter <sup>10</sup> in. (mm)	Minimum Edge Distance in. (mm)	Minimum Spacing in. (mm)	Minimum Steel Strength <sup>3</sup> ASTM	Allowable Tension Load — lb. (kN)					
						1/8"-Thick Steel	3/16"-Thick Steel	1/4"-Thick Steel	3/8"-Thick Steel	1/2"-Thick Steel	3/4"-Thick Steel
Powder Actuated	PDPA PDPAT PDPAWL	0.157 (4.0)	0.5 (13)	1 (25)	A36	—	260 (1.16)	370 (1.65)	380 <sup>7</sup> (1.69)	530 <sup>7</sup> (2.36)	195 <sup>4</sup> (0.87)
			0.5 (13)	1 (25)	A572 Gr. 50 or A992	—	305 (1.36)	335 (1.49)	355 <sup>7</sup> (1.58)	485 <sup>5</sup> (2.16)	170 <sup>6</sup> (0.76)
	PINW PINWP	0.145 (3.7)	0.5 (13)	1 (25)	A36	—	155 (0.69)	—	—	—	—
	PSLV3 Smooth shank	0.205 (5.2)	1 (25)	1½ (38)	A36	—	270 (1.20)	680 (3.02)	—	—	—
	PSLV3-12575K Knurled shank	0.205 (5.2)	1 (25)	1½ (38)	A36	—	270 (1.20)	870 (3.87)	—	—	—
Gas Actuated	GDP	0.106 (2.7)	0.5 (13)	1 (25)	A36	125 (0.56)	210 (0.93)	220 (0.98)	—	—	—
			0.5 (13)	1 (25)	A572 Gr. 50 or A992	—	225 (1.00)	185 (0.82)	—	—	—
	GDPS	0.118/0.102 (3.0/2.6)	0.5 (13)	1 (25)	A36	—	95 (0.42)	170 (0.76)	165 <sup>8</sup> (0.73)	145 <sup>8</sup> (0.64)	—
			0.5 (13)	1 (25)	A572 Gr. 50 or A992	—	110 (0.49)	170 (0.76)	155 <sup>8</sup> (0.69)	—	—
	GW-50	0.128/0.110 (3.3/2.8)	0.5 (13)	1 (25)	A36	—	225 (1.00)	275 (1.22)	245 <sup>9</sup> (1.09)	—	—
			0.5 (13)	1 (25)	A572 Gr. 50 or A992	—	240 (1.07)	215 <sup>9</sup> (0.96)	280 <sup>9</sup> (1.25)	—	—

- The entire pointed portion of the fastener must penetrate through the steel to obtain the tabulated values, unless otherwise indicated.
- The allowable tension values are for the fastener only. Members connected to the steel must be investigated separately in accordance with accepted design criteria.
- Steel strength must comply with the minimum requirements of ASTM A 36 ( $F_y = 36$  ksi,  $F_u = 58$  ksi), ASTM A 572, Grade 50 ( $F_y = 50$  ksi,  $F_u = 65$  ksi), or ASTM A992 ( $F_y = 50$  ksi,  $F_u = 65$  ksi).
- Based upon minimum penetration depth of 0.46" (11.7 mm).
- Based upon minimum penetration depth of 0.58" (14.7 mm).
- Based upon minimum penetration depth of 0.36" (9.1 mm).
- The fastener must be driven to where the point of the fastener penetrates through the steel.
- Based upon minimum penetration depth of 0.35" (8.9 mm).
- Based upon minimum penetration depth of 0.25" (6.4 mm).
- For stepped shank fasteners: (Diameter of shank above the step)/(Diameter of shank below the step.)
- The allowable load values listed are for static load conditions. Refer to ICC-ES ESR-2138 and ESR-2811 code reports for seismic load conditions.

\* See p. 12 for an explanation of the load table icons.

# Gas- and Powder-Actuated Fasteners Design Information – Steel

## Powder-Actuated and Gas-Actuated Fasteners — Allowable Shear Loads in Steel<sup>1</sup>



Direct Fastening Type	Model No.	Shank Diameter <sup>10</sup> in. (mm)	Minimum Edge Distance in. (mm)	Minimum Spacing in. (mm)	Minimum Steel Strength <sup>3</sup> ASTM	Allowable Shear Load — lb. (kN)					
						1/8"-Thick Steel	3/16"-Thick Steel	1/4"-Thick Steel	3/8"-Thick Steel	1/2"-Thick Steel	3/4"-Thick Steel
Powder Actuated	PDPA, PDPAT, PDPAWL	0.157 (4.0)	0.5 (13)	1 (25)	A36	—	410 (1.82)	365 (1.62)	385 <sup>7</sup> (1.71)	385 <sup>7</sup> (1.71)	325 <sup>4</sup> (1.45)
					A572 Gr. 50 or A992	—	420 (1.87)	365 (1.62)	290 <sup>7</sup> (1.29)	275 <sup>7</sup> (1.22)	275 <sup>7</sup> (1.22)
	PINW, PINWP	0.145 (3.7)	0.5 (13)	1 (25)	A36	—	395 (1.76)	—	—	—	—
					PSLV3 Smooth shank	—	770 (3.43)	1,120 (4.98)	—	—	—
Gas Actuated	GDP	0.106 (2.7)	0.5 (13)	1 (25)	A36	285 (1.27)	225 (1.00)	205 (0.91)	—	—	—
					A572 Gr. 50 or A992	—	250 (1.11)	145 (0.64)	—	—	—
	GDPS	0.118/0.102 (3.0/2.6)	0.5 (13)	1 (25)	A36	—	180 (0.80)	265 (1.18)	225 <sup>8</sup> (1.00)	225 <sup>8</sup> (1.00)	—
					A572 Gr. 50 or A992	—	205 (0.91)	305 (1.36)	205 <sup>8</sup> (0.91)	—	—
	GW-50	0.128/0.110 (3.3/2.8)	0.5 (13)	1 (25)	A36	—	400 (1.78)	345 (1.53)	310 <sup>9</sup> (1.38)	—	—
					A572 Gr. 50 or A992	—	380 (1.69)	325 <sup>9</sup> (1.45)	350 <sup>9</sup> (1.56)	—	—

- The entire pointed portion of the fastener must penetrate through the steel to obtain the tabulated values, unless otherwise indicated.
- The allowable shear values are for the fastener only. Members connected to the steel must be investigated separately in accordance with accepted design criteria.
- Steel strength must comply with the minimum requirements of ASTM A 36 ( $F_y = 36$  ksi,  $F_u = 58$  ksi), ASTM A 572, Grade 50 ( $F_y = 50$  ksi,  $F_u = 65$  ksi), or ASTM A992 ( $F_y = 50$  ksi,  $F_u = 65$  ksi).
- Based upon minimum penetration depth of 0.46" (11.7 mm).
- Based upon minimum penetration depth of 0.58" (14.7 mm).
- Based upon minimum penetration depth of 0.36" (9.1 mm).
- The fastener must be driven to where the point of the fastener penetrates through the steel.
- Based upon minimum penetration depth of 0.35" (8.9 mm).
- Based upon minimum penetration depth of 0.25" (6.4 mm).
- For stepped shank fasteners: (Diameter of shank above the step)/(Diameter of shank below the step).
- The allowable load values listed are for static load conditions. Refer to ICC-ES ESR-2138 and ESR-2811 code reports for seismic load conditions.

## Spiral Knurl Pin Allowable Tension and Shear Loads in Cold-Formed Steel Studs



Model No.	Shank Diameter in. (mm)	Minimum Edge Dist. in. (mm)	Minimum Spacing in. (mm)	Designation Thickness mil (gauge)	Allowable Loads	
					Tension lb. (kN)	Shear lb. (kN)
GDPSK-138	0.109 (2.8)	13/16 (2.1)	4 (102)	33 (20)	30 (0.13)	70 (0.31)
				43 (18)	48 (0.21)	89 (0.40)
				54 (16)	92 (0.41)	150 (0.67)
				68 (14)	73 (0.32)	218 (0.97)

- Entire pointed portion of the fastener must penetrate through the cold-formed steel to obtain tabulated values.
- The allowable tension and shear values are for the fastener only. Members connected to the cold-formed steel must be investigated separately in accordance with accepted design criteria.
- Fastener is to be installed in the center of the stud flange.
- Loads are based on cold-formed steel members with a minimum yield strength,  $F_y = 33$  ksi and tensile strength,  $F_u = 45$  ksi for 33 mil (20 ga.) and 43 mil (18 ga.), and minimum yield strength,  $F_y = 50$  ksi and tensile strength,  $F_u = 65$  ksi for 54 mil (16 ga.) and 68 mil (14 ga.)

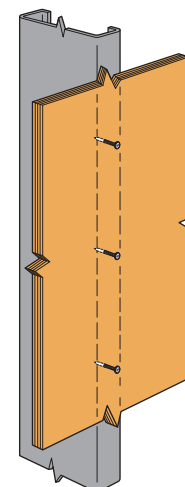

Typical GDPSK Installation

\* See p. 12 for an explanation of the load table icons.

# Restoration Solutions

---





# CSS Composite Strengthening Systems™

Restoration Solutions

## Your Full-Solution Partner for Composite Strengthening Systems

Simpson Strong-Tie® Composite Strengthening Systems (CSS) provide efficient solutions for the structural reinforcement and retrofit of aging, damaged or overloaded concrete, masonry, steel and timber structures.

The primary benefit of Composite Strengthening Systems versus traditional retrofit methods is that significant flexural, axial or shear strength gains can be realized with an easy-to-apply composite that does not add significant weight or mass to the structure. Many times it is the most economical choice given the reduced prep and labor costs and may be installed without taking the structure out of service.

### CSS Advantages

- In-house engineering and technical support
- Increase capacity without significantly increasing weight or mass
- High tensile strength
- Very lightweight and user-friendly installation
- Non-corrosive
- Low aesthetic impact
- Compatible with many finishes and protective coatings
- Economical solution versus conventional methods

For complete information regarding specific products suitable to your unique situation or condition, please visit [strongtie.com/css](http://strongtie.com/css) or call your local RPS specialist or CSS Field Engineer at (800) 999-5099.



Flier F-R-CSS

Flier F-R-FRCM



## CSS Composite Strengthening Systems™

## CSS Solutions

CSS enhances the strength of existing structural elements which require additional strengthening, rehabilitation and repair in such applications as seismic retrofit, structural preservation, force protection, blast mitigation, and corrosion-related repair and rehabilitation. CSS increases strength without adding weight or mass like traditional strengthening methods.

## CSS Reinforcement Solutions for Structural Elements

Reinforcement Type	Structural Element			
	Slab	Beam	Wall	Column/Pile
Externally Applied Laminates	Flexural/Collector	Flexural/Collector	Tensile/Flexural	Flexural
Near-Surface Mounted Laminates	Flexural/Collector	Flexural/Collector	Tensile/Flexural	Flexural
Fabrics	Flexural/Collector	Shear/Flexural/Collector	Shear/Flexural/Tensile	Shear/Flexural/Confinement
FRCM	Flexural/Collector	Shear/Flexural/Collector	Shear/Flexural/Tensile	Shear/Flexural/Confinement



- 1. Slab** — Adds collector reinforcement, negative (not shown) and positive moment flexural capacity
- 2. Slab opening** — Trim reinforcement
- 3. Beam** — Laminates, FRCM or fabrics for flexure and/or collector reinforcement, fabrics or FRCM for shear stirrup reinforcement and potential use of FRP anchors (shown in orange)
- 4. Wall** — Stiffening, flexural, shear or tensile reinforcement with FRCM, fabrics and/or laminates (FRCM shown above)
- 5. New wall opening** — Trim reinforcement
- 6. Column wrapping** — Full column wrap to achieve required strengthening, possibly with additional near-surface mounted laminates, FRCM or fabric for flexure; effective solution for under-reinforced column ties
- 7. Protective coating** — High-performance protection against exposure, corrosion, chemical attack, abrasion, fire resistance and other environmental factors

# CSS Composite Strengthening Systems™

## Components

### Fabric

Several types of code-listed\* and non-code-listed FRP fabrics including carbon fiber and E-glass are available to meet specifier and contractor requirements. Field lamination provides flexibility and short installation time, resulting in lower labor costs and less downtime than are usual with traditional retrofit methods.

- Conforms to any shape
- Can be cut/field-adjusted to address odd shapes/orientations
- May be placed in multiple layers for increased capacity gain
- Variety of tow orientation/composition allows for design flexibility

### Carbon Fiber Fabrics

CSS-CUCF11*	Code-Listed Unidirectional Carbon Fabric — 11 oz./yd. <sup>2</sup> (370 g/m <sup>2</sup> )
CSS-CUCF22*	Code-Listed Unidirectional Carbon Fabric — 22 oz./yd. <sup>2</sup> (740 g/m <sup>2</sup> )
CSS-CUCF44F*	Code-Listed Unidirectional Carbon Fabric — 44 oz./yd. <sup>2</sup> (1,490 g/m <sup>2</sup> )
CSS-UCF10	Unidirectional Carbon Fabric — 10 oz./yd. <sup>2</sup> (340 g/m <sup>2</sup> )
CSS-UCF20	Unidirectional Carbon Fabric — 20 oz./yd. <sup>2</sup> (680 g/m <sup>2</sup> )
CSS-BCF06	Bidirectional Carbon Fabric (0/90°) — 6 oz./yd. <sup>2</sup> (204 g/m <sup>2</sup> )
CSS-BCF018	Bidirectional Carbon Fabric (0/90°) — 18 oz./yd. <sup>2</sup> (611 g/m <sup>2</sup> )
CSS-BCF418	Bidirectional Carbon Fabric (+/- 45°) — 18 oz./yd. <sup>2</sup> (611 g/m <sup>2</sup> )

### E-Glass Fiberglass Fabrics

CSS-CBGF424*	Code-Listed Bidirectional E-Glass Fabric (+/- 45) — 24 oz./yd. <sup>2</sup> (814 g/m <sup>2</sup> )
CSS-BGF012	Bidirectional E-Glass Fabric (0/90°) — 12 oz./yd. <sup>2</sup> (407 g/m <sup>2</sup> )
CSS-BGF018	Bidirectional E-Glass Fabric (0/90°) — 18 oz./yd. <sup>2</sup> (611 g/m <sup>2</sup> )

### Carbon and Fiberglass Anchors

High-strength FRP anchors are field laminated and used to carry load into the concrete to effectively improve bond strength, or through the concrete to transfer load for increased capacity. Termination and through anchors in carbon and fiberglass are available in diameters from ¼ in. (6.4 mm) to 1½ in. (38.1 mm) in commonly used stock and custom lengths.

CSS-CA	Carbon Fiber Anchor
CSS-GA	Fiberglass Anchor

### Epoxies

CSS-ES-3KT	Epoxy Primer and Saturant — 3 US gallon (11.4 L)
CSS-ES-150KT	Epoxy Primer and Saturant — 150 US gallon (567.8 L)
CSS-EP-3KT	Epoxy Paste and Filler — 3 US gallon (11.4 L)

### Protective Coatings

FX505GR05-5	FX-505 Water-Based Acrylic Coating — 5 US gallon (18.9 L)
FX-70-9GN01KT3	FX-70-9™ Epoxy Coating — 3 US gallon (11.4 L) kit
FX70-9GN01KT15	FX-70-9 Epoxy Coating — 15 US gallon (56.8 L) kit
FX207KT1-1	FX-207 Slurry Seal — 3.3 US gallon (12.5 L) kit

### Fire Insulation

FX-207 Slurry Seal may be applied over CSS FRP materials for fire insulation and flame-spread/smoke-developed coating providing a 4-hour rated system per ASTM E119 and UL 263 and a Class A finish for ASTM E84 flame-spread and smoke-developed classification.



For use in beam/slab external reinforcing system fire resistance classification. See UL Fire Resistance Directory (R37897).

\* Code-listed fabrics and laminates (ICC-ES ESR-3403) have been evaluated per ICC-ES AC125 for Concrete and Reinforced and Unreinforced Masonry Strengthening Using Externally Bonded Fiber-Reinforced Polymer (FRP) Composite Systems.

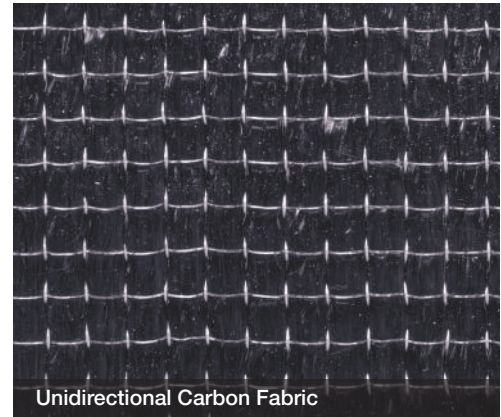

Unidirectional Carbon Fabric



Unidirectional E-Glass Fabric



Carbon Termination Anchor



FX-70-9 Epoxy Coating applied over Carbon Fiber Fabric

# CSS Composite Strengthening Systems™

## Components (cont.)

### Precured Carbon-Fiber Laminate

CSS-CUCL is an epoxy-based, pultruded, unidirectional, high-strength, non-corrosive carbon-fiber-reinforced polymer (CFRP) precured laminate for both surface mounted and near surface mounted (NSM) structural reinforcement applications.

- Code listed (ICC-ES ESR-3403) per ICC-ES AC125
- No field saturation required
- Highest tensile capacity available
- Lower overall installed cost/labor savings
- Available in a variety of widths and thicknesses and may be cut to length

CSS-CUCL                      Code-Listed Unidirectional Carbon Laminate  
 CSS-EP                        Epoxy Paste and Filler

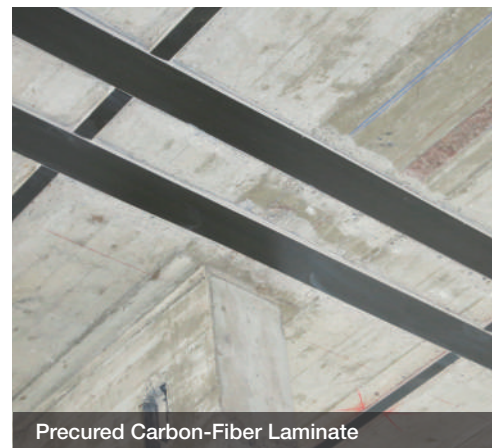

Precured Carbon-Fiber Laminate

### Fabric-Reinforced Cementitious Matrix (FRCM)

Repair, protect and strengthen aging, damaged or overloaded concrete and masonry structures in one application and significantly reduce your installed cost. FRCM or Fabric-Reinforced Cementitious Matrix combines high-performance sprayable mortar with carbon-fiber grid to create thin-walled, reinforced concrete shells without adding significant weight or mass to the structure.

#### Benefits

- Code listed (ICC-ES ESR-3506) per ICC-ES AC434 for concrete and unreinforced masonry strengthening
- Repair and strengthen structures using only a thin layer of material
- Can be applied in multiple grid layers (four maximum) to achieve desired strengthening
- Lightweight system for vertical surfaces and overhead applications
- Suitable for harsh environments or service conditions including marine locations, elevated temperatures, humidity, abrasion and UV
- Works on damp substrates
- Installation process is similar to that for wet shotcrete repair mortars
- Quick installation with less preparation than traditional shotcrete repairs with rebar
- Does not create a vapor barrier
- Matches substrate finish

CSS-CM                      Cementitious Matrix — 55 lb. (24.9 kg) bag  
 CSS-BCG19550          Bidirectional Carbon Grid  
 CSS-HBCG19550        Heavy Bidirectional Carbon Grid  
 CSS-UCG19550        Unidirectional Carbon Grid



Fabric-Reinforced Cementitious Matrix (FRCM)



For use in beam/slab external reinforcing system fire resistance classification. See UL Fire Resistance Directory (R37897).

For complete information, please visit [strongtie.com/css](http://strongtie.com/css) or call (800) 999-5099.

# In-house Engineering and Technical Services

We recognize that specifying Simpson Strong-Tie® Composite Strengthening Systems™ is unlike choosing any other product we offer. Leverage our expertise to help with your strengthening designs.

## Our Engineering and Technical Services Include:

### Assessment

- Feasibility studies to ensure suitable solutions for your application
- Partnering with trained and licensed contractors to provide rough order-of-magnitude (ROM) budget estimates

### Complete Engineering Package

- Complete engineering package
- Specifications prepared to your unique project requirements
- Detailed proposal documentation, including drawings
- Calculations provided for Engineer of Record reference during submittal review
- Calculations for each unique element
- Elevation drawings for each element and component
- Typical detail sheet showing installation details
- General notes to include in the plans
- Signed and sealed documents for all 50 states and throughout Canada

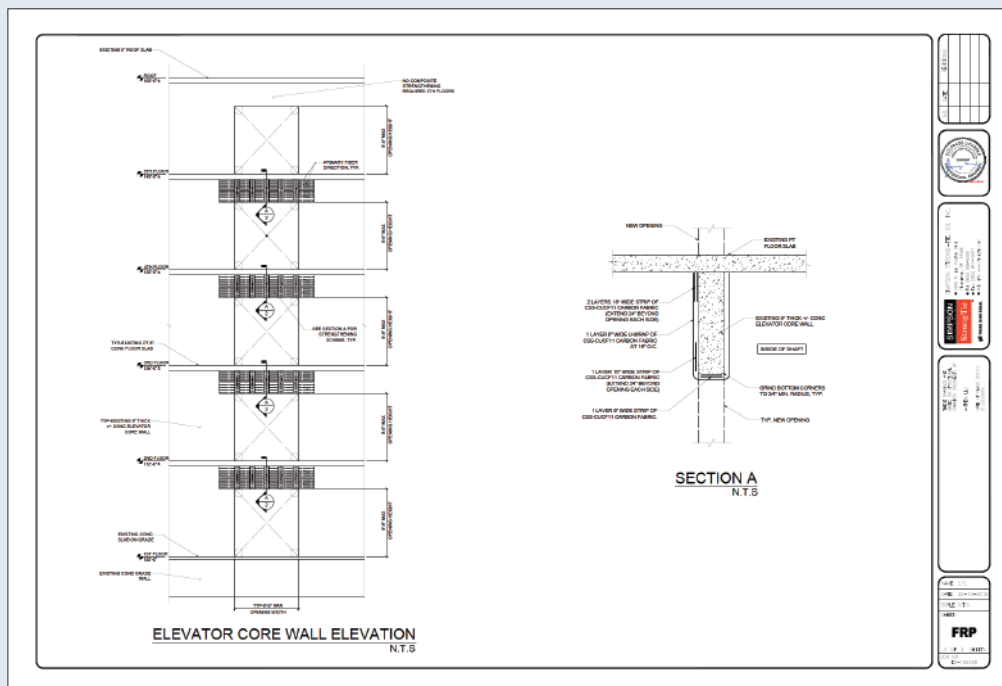



## FX-70® Structural Pile Repair and Protection System

### FX-70 Structural Pile Repair and Protection System for Concrete, Timber and Steel Structures

Degradation of structures at the waterline is common in marine environments. Tidal action, river current, saltwater exposure, chemical intrusion, floating debris, marine borers, electrolysis, wet-dry cycles and general weathering are all examples of destructive marine factors addressed by the FX-70 Structural Repair and Protection System.

The FX-70 system features custom-made tongue-and-groove seamed fiberglass jackets that provide a corrosion-resistant protective shell for the life of the repair. High-strength repair grouts are used to strengthen and protect damaged piles. These products displace existing water and can be easily pumped or poured into the FX-70 jacket even while it is submerged in water.

#### FX-70 System Advantages

- Economically repair damage to concrete, timber and steel pilings without taking the structure out of service
- No need for cofferdams or dewatering
- No need for heavy lifting equipment
- Resists corrosion, deterioration, weathering and abrasion to protect and prevent deterioration of steel, concrete and timber pilings
- Low-impact installation in marine environments
- Easily blends with existing structure
- Economically repair damage to timber piles without taking the structure out of service
- Protect or prevent further deterioration of and steel pilings instead of replacing them
- Manufactured in the U.S.

To learn more, visit [strongtie.com/fx70](http://strongtie.com/fx70) or call (800) 999-5099.

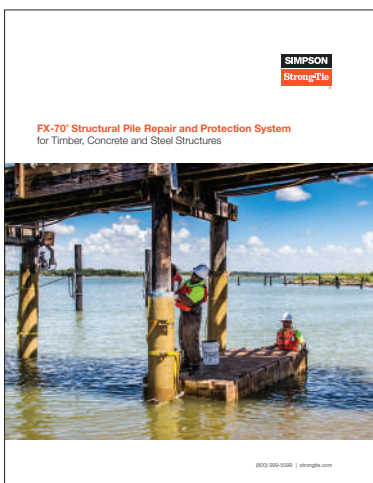

Watch How to Install FX-70 Jackets in Water at [strongtie.com/videolibrary](http://strongtie.com/videolibrary).

Flier F-R-FX70



# FX-70® Structural Pile Repair and Protection System

The FX-70 structural pile repair and protection system is customized to the exact specifications of each job, manufactured in the U.S.A., and shipped directly to your job site. The FX-70 tongue-and-groove seamed jacket provides a corrosion-resistant shell with over 40 years of demonstrated in-service performance.

## Components

**Cross-Section of Tongue-and-Groove Joint**

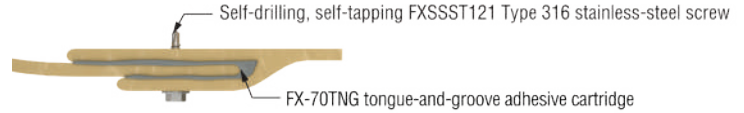

### Epoxy Grout Method

Typically for Section Loss ≤ 25%

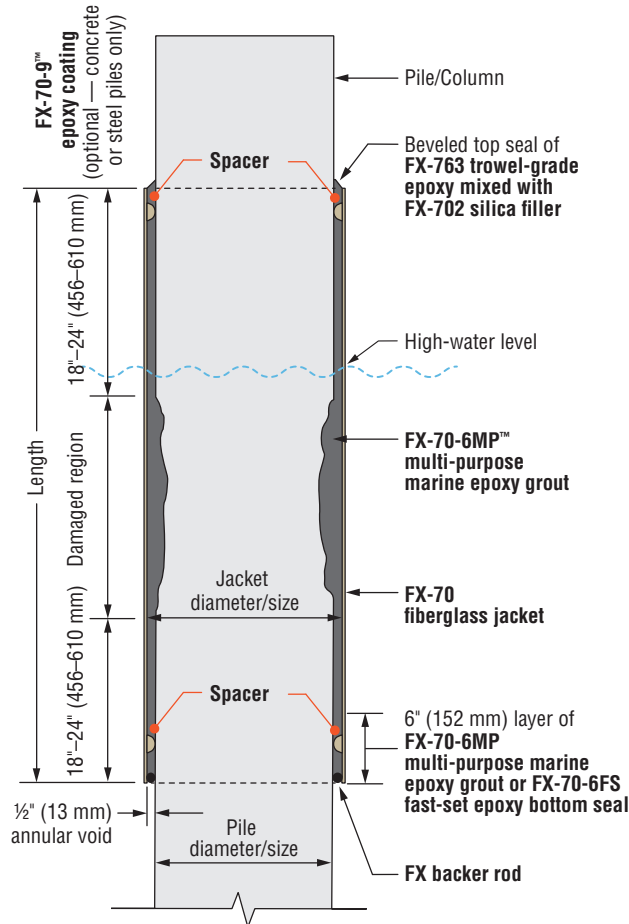

- **FX-70-6MP multi-purpose marine epoxy grout** used for bottom seal and repair
- Typical annular void of 1/2" (13 mm)
- 3/4" (19 mm) annular void for H-piles

### Cementitious Grout Combination Method

Typically for Section Loss > 25%

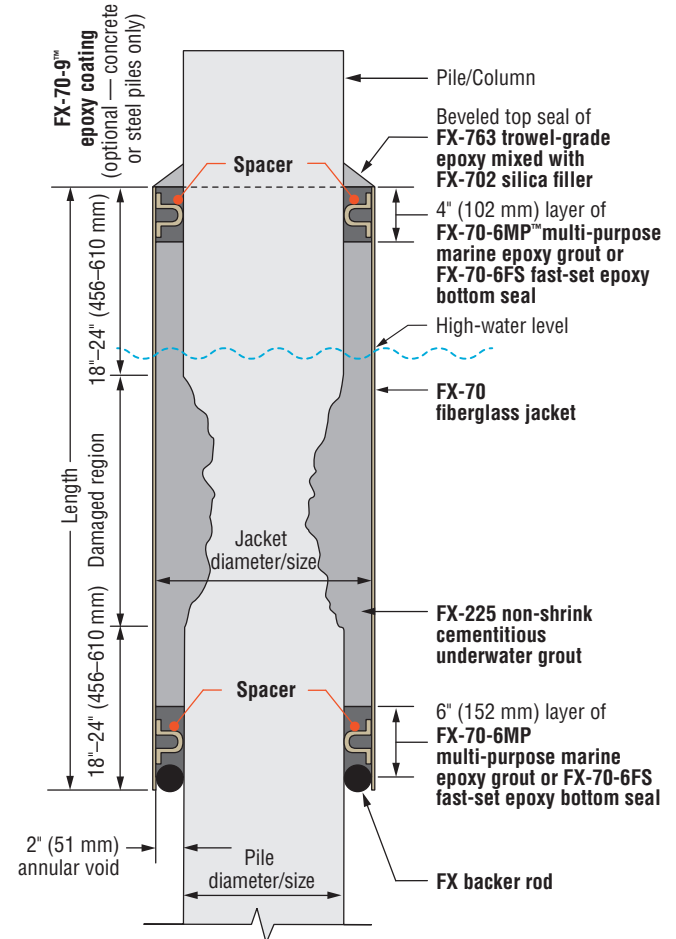

- **FX-70-6MP multi-purpose marine epoxy grout** used for top and bottom seal
- **FX-225 non-shrink underwater grout** used for repair
- Typical annular void of 2" (51 mm)

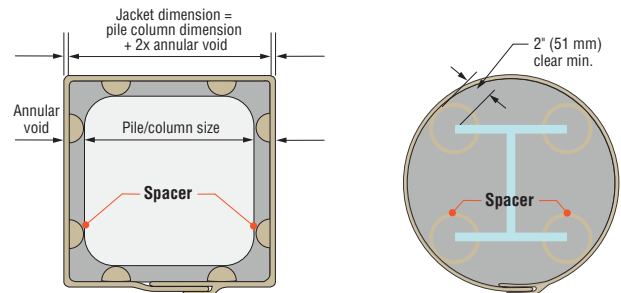
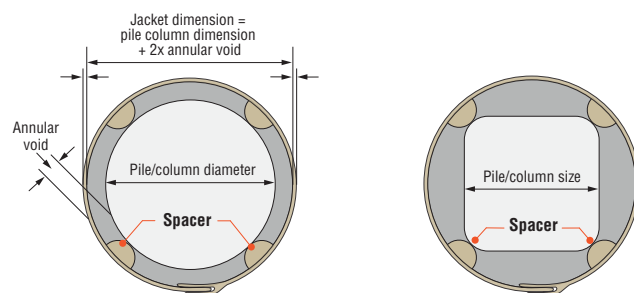

# CI-SLV Super-Low-Viscosity Injection Epoxy

CI-SLV super-low-viscosity structural injection epoxy is a two-component, high-modulus, high-solids, moisture-tolerant epoxy specially designed for pressure injection, gravity feeding and flood coat filling of concrete cracks when substrate temperatures are between 60°F (16°C) to 90°F (32°C). Available in 3-gallon bulk kits or convenient side-by-side cartridges dispensed through a static mixing nozzle using either a manual or pneumatic dispensing tool.

## Features

- Chemically bonds with the concrete to provide a structural repair. CI-SLV seals the crack from moisture, protecting rebar in the concrete from corrosion.
- Moisture-tolerant, can be used on dry and damp surfaces
- Low surface tension allows the material to effectively penetrate narrow cracks
- Formulated for maximum penetration under pressure
- Non-shrink and resistant to oils, salts and mild chemicals
- Can be used with metered pressure-injection equipment
- Freeze-thaw resistant

## Applications

- Pressure injection
- Gravity feed
- Underwater pressure injection
- Flood coat

## Product Information

Mix Ratio/Type	2:1
Mixed Color	Clear
Crack Width	0.002" – 0.25" (0.05 mm – 6 mm)
Shelf Life	24 months
Storage Temperature	45°F (7°C) – 90°F (32°C)
Volatile Organic Compound (VOC)	8 g/L mixed
Yield	231 in. <sup>3</sup> /US gal. (0.001 m <sup>3</sup> /L)
For Flood-Coat Applications	150 – 200 ft. <sup>2</sup> /US gal. (3.7 – 4.9 m <sup>2</sup> /L) depending on surface profile and porosity
Pot Life, 1 Quart	6 minutes at 90°F (32°C) 25 minutes at 72°F (22°C)
Thin Film (5 mil)	Set to touch: 4 hrs.
Cure Time at 72°F, ASTM D5895	Dry through: 9 hrs.
Manufactured in the USA using global materials	

## Code Reports, Standards and Compliance

ASTM C881 and AASHTO M235      Type I/IV; Grade 1; Class C

## Installation Instructions

Installation instructions are located at the following locations: pp. 224–229, product packaging or on the CI-SLV Technical Data Sheet at [strongtie.com/rps](http://strongtie.com/rps).

## Accessories

See p. 223 for information on crack repair accessories.

## CI-SLV Packaging Information

Model No.	Capacity (ounces)	Packaging Type	Package Quantity	Carton Quantity	Dispensing Tools	Mixing Nozzle
CISLV32	32	Side-by-side cartridge	1	5	ADT30S, ADT30P	EMN022 (included)
CISLV3KT	384	3 gallon bulk kit	1 case of (3) gallon cans	—	Metering pumps offered by third-party manufacturers	—

1. Cartridge estimation guidelines are available at [strongtie.com/apps](http://strongtie.com/apps).



CI-SLV



# CI-SLV Super Low Viscosity Injection Epoxy

## Technical Information

### Compressive Strength

Cure Time	60°F (16°C) psi (MPa)	72°F (22°C) psi (MPa)	90°F (32°C) psi (MPa)	Test Standard
4-hour cure	—	—	10,250 (70.7)	ASTM D695
8-hour cure	—	4,450 (30.7)	11,500 (79.3)	
16-hour cure	5,750 (39.6)	10,200 (70.3)	11,700 (80.7)	
24-hour cure	7,600 (52.4)	11,250 (77.6)	11,900 (82.0)	
3-day cure	12,800 (88.3)	13,150 (90.7)	12,250 (84.5)	
7-day cure	13,400 (92.4)	13,300 (91.7)	12,500 (86.2)	
14-day cure	13,700 (94.5)	13,600 (93.8)	12,500 (86.2)	
28-day cure	13,700 (94.5)	14,200 (97.9)	12,500 (86.2)	

Temperature Range	>60°F (16°C)	Test Standard
Epoxy Classification	Types I, IV; Grade I (LV)	ASTM C881
Viscosity — mixed <sup>1</sup>	150 cP	ASTM D2556
Gel Time — 60 gram mass <sup>1</sup>	40 minutes	ASTM C881
Bond Strength, Slant Shear: Hardened to Hardened Concrete — 2-day cure <sup>2</sup> Hardened to Hardened Concrete — 14-day cure <sup>2</sup>	2,200 psi (15.2 MPa) 3,600 psi (24.8 MPa)	ASTM C882
Tensile Strength — 7-day cure <sup>2</sup>	7,500 psi (51.7 MPa)	ASTM D638
Elongation at Break — 7-day cure <sup>2</sup>	2.14%	ASTM D638
Flexural Strength — 7-day cure <sup>2</sup>	7,300 psi (50.3 MPa)	ASTM D790
Modulus of Elasticity in Compression — 7-day cure <sup>2</sup>	318,000 psi (2,192.5 MPa)	ASTM D695
Heat Deflection Temperature — 7-day cure <sup>3</sup>	122°F (50°C)	ASTM D648
Glass Transition Temperature — 7-day cure <sup>3</sup>	128°F (53°C)	ASTM E1356
Water Absorption — 14-day cure <sup>4</sup>	0.51%	ASTM D570
Linear Coefficient of Shrinkage <sup>3</sup>	0.005	ASTM D2566
Coefficient of Thermal Expansion <sup>3</sup>	2.89 x 10 <sup>-5</sup> in./in.°F 5.20 x 10 <sup>-5</sup> cm/cm°C	ASTM C531
Shore D Hardness — 24-hour cure <sup>3</sup>	82	ASTM D2240
Shore D Hardness — 7-day cure <sup>3</sup>	82	ASTM D2240
Adhesion to Concrete — 24-hour cure <sup>3</sup>	1,100 psi (7.6 MPa)	ASTM D7234

1. Tested at 72°F (22°C).

2. Cured at 60°F (16°C).

3. Cured at 72°F (22°C).

4. Cured at 72°F (22°C), immersed in water 24 hours.

## CI-LV Low-Viscosity Injection Epoxy

CI-LV low-viscosity structural injection epoxy is a two-component, high-modulus, high-solids, moisture-tolerant epoxy specially designed for pressure injection, gravity feeding and flood coat filling of concrete cracks and for increasing the bond between freshly placed repair mortars or concrete mixes and existing concrete when substrate temperatures are between 40°F (4°C) to 90°F (32°C). Available in 3-gallon bulk kits or convenient side-by-side cartridges dispensed through a static mixing nozzle using either a manual or pneumatic dispensing tool.

### Features

- Chemically bonds with the concrete to provide a structural repair. CI-LV seals the crack from moisture, protecting rebar in the concrete from corrosion.
- Approved under NSF/ANSI Standard 61 (719 in.<sup>2</sup> /1,000 gal.)
- Moisture-tolerant, can be used on dry and damp surfaces
- Low surface tension allows the material to effectively penetrate narrow cracks
- Formulated for maximum penetration under pressure
- Non-shrink and resistant to oils, salts and mild chemicals
- Can be used with metered pressure-injection equipment
- Freeze-thaw resistant

### Applications

- Pressure injection
- Gravity feed
- Repair mortar
- Underwater pressure injection
- Flood coat
- Bonding agent

### Product Information

Mix Ratio/Type	2:1
Mixed Color	Dark amber
Crack Width	0.002" – 0.25" (0.05 mm – 6 mm)
Shelf Life	24 months
Storage Temperature	45°F (7°C) – 90°F (32°C)
Base Material Temperature	40°F (4°C) – 90°F (32°C)
Volatile Organic Compound (VOC)	2 g/L mixed
Yield	231 in. <sup>3</sup> /US gal. (0.001 m <sup>3</sup> /L)
For Flood-Coat Applications	150 – 200 ft. <sup>2</sup> /US gal. (3.7 – 4.9 m <sup>2</sup> /L) depending on surface profile and porosity
Pot Life, 1 Quart	10 minutes at 90°F (32°C) 25 minutes at 72°F (22°C) 100 minutes at 50°F (10°C)
Thin Film (5 mil)	Set to touch: 3 hrs. 50 min.
Cure Time at 72°F, ASTM D5895	Dry through: 6 hrs. 15 min.
Manufactured in the USA using global materials	

### Code Reports, Standards and Compliance

ASTM C881 and AASHTO M235	Type I/II; Grade 1; Class B, Type I/IV and II/V, Grade 1, Class C
NSF/ANSI/CAN 61	(216 in. <sup>2</sup> / 1,000 gal.)

### Installation Instructions

Installation instructions are located at the following locations: pp. 224–229, product packaging or on the CI-LV Technical Data Sheet at [strongtie.com/rps](http://strongtie.com/rps).

### Accessories

See p. 223 for information on crack repair accessories.

### CI-LV Packaging Information

Model No.	Capacity (ounces)	Packaging Type	Package Quantity	Carton Quantity	Dispensing Tools	Mixing Nozzle
CI-LV32	32	Side-by-side cartridge	1	5	ADT30S, ADT30P	EMN022 (included)
CI-LV3KT	384	3 gallon bulk kit	1 case of (3) gallon cans	—	Metering pumps offered by third-party manufacturers	—

1. Cartridge estimation guidelines are available at [strongtie.com/apps](http://strongtie.com/apps).



CI-LV

# CI-LV Low-Viscosity Injection Epoxy

## Technical Information

### Compressive Strength

Cure Time	40°F (4°C) psi (MPa)	60°F (16°C) psi (MPa)	72°F (22°C) psi (MPa)	90°F (32°C) psi (MPa)	Test Standard
4-hour cure	—	—	—	9,800 (67.6)	ASTM D695
8-hour cure	—	—	5,000 (34.5)	10,100 (69.6)	
16-hour cure	—	—	9,100 (62.7)	10,350 (71.4)	
24-hour cure	—	6,250 (43.0)	9,250 (63.8)	10,450 (72)	
3-day cure	5,350 (36.9)	10,800 (74.5)	10,700 (73.8)	11,150 (76.9)	
7-day cure	9,100 (62.7)	11,250 (77.6)	11,000 (75.8)	11,150 (76.9)	
14-day cure	11,000 (75.8)	11,800 (81.4)	11,250 (77.6)	11,150 (76.9)	
28-day cure	12,150 (83.8)	12,000 (82.7)	11,600 (80.0)	11,450 (78.9)	

Temperature Range	Class B 40°–60°F (4°C–16°C)	Class C >60°F (16°C)	Test Standard
Epoxy Classification	Types I, II; Grade I (LV)	Types I, II, IV, V; Grade I (LV)	ASTM C881
Viscosity — mixed <sup>1</sup>	1,500 cP	350 cP	ASTM D2556
Gel Time — 60 gram mass <sup>1</sup>	400 minutes	45 minutes	ASTM C881
Bond Strength, Slant Shear: Hardened to Hardened Concrete — 2-day cure <sup>2</sup> Hardened to Hardened Concrete — 14-day cure <sup>2</sup> Fresh to Hardened Concrete — 14-day cure <sup>3</sup>	1,100 psi (7.6 MPa) 2,150 psi (14.8 MPa) 1,850 psi (12.8 MPa)	2,400 psi (16.5 MPa) 3,450 psi (23.8 MPa) 1,850 psi (12.8 MPa)	ASTM C882
Tensile Strength — 7-day cure <sup>2</sup>	5,550 psi (38.2 MPa)	7,950 psi (54.8 MPa)	ASTM D638
Elongation at Break — 7-day cure <sup>2</sup>	2.2%	3.2%	ASTM D638
Flexural Strength — 14-day cure <sup>2</sup>	5,500 psi (37.9 MPa)	11,900 psi (82.0 MPa)	ASTM D790
Modulus of Elasticity in Compression — 7-day cure <sup>2</sup>	318,000 psi (2,190 MPa)	382,000 psi (2,630 MPa)	ASTM D695
Heat Deflection Temperature — 7-day cure <sup>3</sup>	127°F (53°C)		ASTM D648
Glass Transition Temperature — 7-day cure <sup>3</sup>	136°F (58°C)		ASTM E1356
Water Absorption — 7-day cure <sup>4</sup>	0.27%		ASTM D570
Linear Coefficient of Shrinkage <sup>3</sup>	0.005		ASTM D2566
Coefficient of Thermal Expansion <sup>3</sup>	5.82 x 10 <sup>-5</sup> in./in.°F 1.05 x 10 <sup>-4</sup> cm/cm°C		ASTM C531
Shore D Hardness — 24-hour cure <sup>3</sup>	82		ASTM D2240
Shore D Hardness — 7-day cure <sup>3</sup>	82		ASTM D2240
Adhesion to Concrete — 24-hour cure <sup>3</sup>	1,100 psi (7.6 MPa)		ASTM D7234

1. Class B tested at 50°F (10°C), Class C tested at 72°F (22°C).

2. Class B cured at 40°F (4°C), Class C cured at 60°F (16°C).

3. Cured at 72°F (22°C).

4. Cured at 72°F (22°C), immersed in water 24 hours.

## Technical Information — When Used as a Mortar

Tests performed at 1 part by volume of mixed CI-LV to 5 parts by volume of FX-702.

Pot life: 120 minutes at 72°F.

### Compressive Strength

Cure Time	40°F (4°C) psi (MPa)	60°F (16°C) psi (MPa)	72°F (22°C) psi (MPa)	Test Standard
1-day cure	250 (1.7)	6,650 (45.9)	7,600 (52.4)	ASTM C579
7-day cure	6,500 (44.8)	7,200 (49.6)	8,100 (55.8)	
28-day cure	6,600 (45.5)	7,350 (50.7)	8,400 (57.9)	

Temperature Range	72°F (22°C) psi (MPa)	Test Standard
Flexural Strength — 7-day cure	2,250 (15.5)	ASTM C580
Tensile Strength — 7-day cure	1,200 (8.3)	ASTM C307
Bond Strength, Slant Shear Hardened to Fresh Mortar — 7-day cure	1,350 (9.3)	ASTM C882

# CI-LV FS Low-Viscosity Fast-Setting Injection Epoxy

CI-LV FS fast-setting low-viscosity structural injection epoxy is a two-component, high-modulus, high-solids, moisture-tolerant epoxy specially designed for pressure injection of concrete cracks and for increasing the bond between freshly placed repair mortars or concrete mixes and existing concrete when substrate temperatures are between 40°F (4°C) to 90°F (32°C). Available in 3-gallon bulk kits or convenient side-by-side cartridges dispensed through a static mixing nozzle using either a manual, battery-powered or pneumatic dispensing tool.

## Features

- Chemically bonds with the concrete to provide a structural repair. CI-LV FS seals the crack from moisture, protecting rebar in the concrete from corrosion.
- Moisture-tolerant, can be used on dry and damp surfaces
- Low surface tension allows the material to effectively penetrate narrow cracks
- Formulated for maximum penetration under pressure
- Non-shrink and resistant to oils, salts and mild chemicals
- Can be used with metered pressure-injection equipment
- Freeze-thaw resistant

## Applications

- Pressure injection
- Underwater pressure injection
- Gravity feed
- Flood coat
- Bonding agent

## Product Information

Mix Ratio/Type	2:1
Mixed Color	Amber
Crack Width	0.016" – 0.25" (0.4 mm – 6 mm)
Shelf Life	24 months
Storage Temperature	45°F (7°C) – 90°F (32°C)
Base Material Temperature	40°F (4°C) – 90°F (32°C)
Volatile Organic Compound (VOC)	13 g/L mixed
Yield	231 in. <sup>3</sup> /US gal. (0.001 m <sup>3</sup> /L)
For Flood-Coat Applications	150 – 200 ft. <sup>2</sup> /US gal. (3.7 – 4.9 m <sup>2</sup> /L) depending on surface profile and porosity
Pot Life, 1 Quart	10 minutes at 72°F (22°C) 28 minutes at 50°F (10°C)
Thin Film (5 mil)	Set to touch: 1 hr. 45 min.
Cure Time at 72°F, ASTM D5895	Dry through: 4 hrs.
Manufactured in the USA using global materials	

## Code Reports, Standards and Compliance

ASTM C881 and AASHTO M235      Type I/II; Grade 1; Class B,  
Type I/IV and II/V, Grade 1, Class C

## Installation Instructions

Installation instructions are located at the following locations: pp. 224–229, product packaging or on the CI-LV FS Technical Data Sheet at [strongtie.com/rps](http://strongtie.com/rps).

## Accessories

See p. 223 for information on crack repair accessories.

## CI-LV FS Packaging Information

Model No.	Capacity (ounces)	Packaging Type	Package Quantity	Carton Quantity	Dispensing Tools	Mixing Nozzle
CILVFS32	32	Side-by-side cartridge	1	5	ADT30S, ADT30P	EMN022 (included)
CILVFS3KT	384	3 gallon bulk kit	1 case of (3) gallon cans	—	Metering pumps offered by third-party manufacturers	—

1. Cartridge estimation guidelines are available at [strongtie.com/apps](http://strongtie.com/apps).



CI-LV FS

## CI-LV FS Low-Viscosity Fast-Setting Injection Epoxy

## Technical Information

## Compressive Strength

Cure Time	23°F (-5°C) psi (MPa)	40°F (4°C) psi (MPa)	60°F (16°C) psi (MPa)	72°F (22°C) psi (MPa)	Test Standard
1-hour cure	—	—	—	9,500 (65.5)	ASTM D695
2-hour cure	—	—	—	11,250 (77.6)	
4-hour cure	—	—	—	11,600 (80.0)	
8-hour cure	—	—	—	11,700 (80.7)	
16-hour cure	—	—	7,150 (49.3)	11,800 (81.4)	
24-hour cure	—	—	8,350 (57.6)	11,800 (81.4)	
3-day cure	—	6,600 (45.5)	12,800 (88.3)	12,800 (88.3)	
7-day cure	2,250 (15.5)	12,600 (86.9)	13,700 (94.5)	13,500 (93.1)	
14-day cure	2,850 (19.7)	13,700 (94.5)	14,500 (100.0)	13,600 (93.8)	
28-day cure	2,900 (20.0)	14,500 (100.0)	15,200 (104.8)	13,600 (93.8)	

Temperature Range	Class B 40°–60°F (4°C–16°C)	Class C >60°F (16°C)	Test Standard
Epoxy Classification	Types I, II; Grade I (LV)	Types I, II, IV, V; Grade I (LV)	ASTM C881
Viscosity — mixed <sup>1</sup>	2,000 cP	600 cP	ASTM D2556
Gel Time — 60 gram mass <sup>1</sup>	55 minutes	12 minutes	ASTM C881
Bond Strength, Slant Shear: Hardened to Hardened Concrete — 2-day cure <sup>2</sup> Hardened to Hardened Concrete — 14-day cure <sup>2</sup> Fresh to Hardened Concrete — 14-day cure <sup>3</sup>	1,700 psi (11.7 MPa) 3,850 psi (26.5 MPa) 2,150 psi (14.8 MPa)	3,650 psi (25.2) 4,000 psi (27.6 MPa) 2,150 psi (14.8 MPa)	ASTM C882
Tensile Strength — 7-day cure <sup>2</sup>	5,300 psi (36.5 MPa)	7,900 psi (54.5 MPa)	ASTM D638
Elongation at Break — 7-day cure <sup>2</sup>	1.06%	1.91%	ASTM D638
Flexural Strength — 7-day cure <sup>2</sup>	5,700 psi (39.3 MPa)	9,350 psi (64.5 MPa)	ASTM D790
Modulus of Elasticity in Compression — 7-day cure <sup>2</sup>	442,000 psi (3,050 MPa)	439,000 psi (3,030 MPa)	ASTM D695
Heat Deflection Temperature — 7-day cure <sup>3</sup>	122°F (50°C)		ASTM D648
Glass Transition Temperature — 7-day cure <sup>3</sup>	132°F (56°C)		ASTM E1356
Water Absorption — 7-day cure <sup>4</sup>	0.23%		ASTM D570
Linear Coefficient of Shrinkage <sup>3</sup>	0.004		ASTM D2566
Coefficient of Thermal Expansion <sup>3</sup>	4.78 x 10 <sup>-5</sup> in./in.°F 8.60 x 10 <sup>-5</sup> cm/cm°C		ASTM C531
Shore D Hardness — 24-hour cure <sup>3</sup>	80		ASTM D2240
Shore D Hardness — 7-day cure <sup>3</sup>	82		ASTM D2240
Adhesion to Concrete — 24-hour cure <sup>3</sup>	1,100 psi (7.6 MPa)		ASTM D7234

1. Class B tested at 50°F (10°C), Class C tested at 72°F (22°C).

2. Class B cured at 40°F (4°C), Class C cured at 60°F (16°C).

3. Cured at 72°F (22°C).

4. Cured at 72°F (22°C), immersed in water 24 hours.

## Technical Information — When Used as a Mortar

Tests performed at 1 part by volume of mixed CI-LV FS to 5 parts by volume of FX-702.

Pot life: 40 minutes at 72°F (22°C).

## Compressive Strength

Cure Time	40°F (4°C) psi (MPa)	60°F (16°C) psi (MPa)	72°F (22°C) psi (MPa)	Test Standard
1-day cure	3,500 (24.1)	7,800 (53.8)	9,150 (63.1)	ASTM C579
7-day cure	7,600 (52.4)	8,850 (61.0)	10,000 (68.9)	
28-day cure	7,700 (53.1)	8,950 (61.7)	10,150 (70.0)	

Temperature Range	72°F (22°C) psi (MPa)	Test Standard
Flexural Strength — 7-day cure	1,900 (13.1)	ASTM C580
Tensile Strength — 7-day cure	1,350 (9.3)	ASTM C307
Bond Strength, Slant Shear Hardened to Fresh Mortar — 7-day cure	1,800 (12.4)	ASTM C882

# CI-LPL Low-Viscosity Long-Pot-Life Injection Epoxy

CI-LPL long-pot-life structural injection epoxy is a two-component, high-modulus, high-solids, moisture-tolerant epoxy specially designed for pressure injection, gravity feeding and flood coat filling of concrete cracks when substrate temperatures are between 60°F (16°C) to 110°F (43°C). Available in 3-gallon bulk kits or convenient side-by-side cartridges dispensed through a static mixing nozzle using either a manual or pneumatic dispensing tool.

## Features

- Chemically bonds with the concrete to provide a structural repair. CI-LPL seals the crack from moisture, protecting rebar in the concrete from corrosion.
- Moisture-tolerant, can be used on dry and damp surfaces
- Formulated for use in hot environments to 110°F
- Low surface tension allows the material to effectively penetrate narrow cracks
- Formulated for maximum penetration under pressure
- Non-shrink and resistant to oils, salts and mild chemicals
- Can be used with metered pressure-injection equipment
- Freeze-thaw resistant

## Applications

- Pressure injection
- Gravity feed
- Underwater pressure injection

## Product Information

Mix Ratio/Type	2:1
Mixed Color	Amber
Crack Width	0.016" – 0.25" (0.4 mm – 6 mm)
Shelf Life	24 months
Storage Temperature	45°F (7°C) – 90°F (32°C)
Base Material Temperature	60°F (16°C) – 110°F (43°C)
Volatile Organic Compound (VOC)	< 1 g/L mixed
Yield	231 in. <sup>3</sup> /US gal. (0.001 m <sup>3</sup> /L)
For Flood-Coat Applications	150 – 200 ft. <sup>2</sup> /US gal. (3.7 – 4.9 m <sup>2</sup> /L) depending on surface profile and porosity
Pot Life, 1 Quart	20 minutes at 90°F (32°C) 60 minutes at 72°F (22°C)
Thin Film (5 mil)	Set to touch: 6 hrs. 30 min.
Cure Time at 72°F, ASTM D5895	Dry through: 16 hrs. 30 min.
Thin Film (5 mil)	Set to touch: 3 hrs.
Cure Time at 95°F, ASTM D5895	Dry through: 4 hrs.
Manufactured in the USA using global materials	

## Code Reports, Standards and Compliance

ASTM C881 and AASHTO M235      Type I/IV; Grade 1; Class C

## Installation Instructions

Installation instructions are located at the following locations: pp. 224–229, product packaging or on the CI-LPL Technical Data Sheet at [strongtie.com/rps](http://strongtie.com/rps).

## Accessories

See p. 223 for information on crack repair accessories.

## CI-LPL Packaging Information

Model No.	Capacity (ounces)	Packaging Type	Package Quantity	Carton Quantity	Dispensing Tools	Mixing Nozzle
CILPL32	32	Side-by-side cartridge	1	5	ADT30S, ADT30P	EMN022 (included)
CILPL3KT	384	3 gallon bulk kit	1 case of (3) gallon cans	—	Metering pumps offered by third-party manufacturers	—

1. Cartridge estimation guidelines are available at [strongtie.com/apps](http://strongtie.com/apps).



CI-LPL

## CI-LPL Low-Viscosity Long-Pot-Life Injection Epoxy

## Technical Information

## Compressive Strength

Cure Time	60°F (16°C) psi (MPa)	72°F (22°C) psi (MPa)	90°F (32°C) psi (MPa)	110°F (43°C) psi (MPa)	Test Standard
8-hour cure	—	—	6,900 (47.6)	10,000 (70.0)	ASTM D695
16-hour cure	—	—	9,900 (68.3)	10,100 (69.6)	
24-hour cure	—	6,800 (46.9)	10,900 (75.2)	10,200 (70.3)	
3-day cure	8,450 (58.3)	9,900 (68.3)	11,200 (77.2)	10,200 (70.3)	
7-day cure	10,400 (71.7)	10,800 (74.5)	11,200 (77.2)	10,200 (70.3)	
14-day cure	11,600 (80.0)	11,500 (79.3)	11,200 (77.2)	10,200 (70.3)	
28-day cure	12,000 (82.7)	11,700 (80.7)	11,400 (78.6)	10,400 (71.7)	

Temperature Range	60°F (16°C)	72°F (22°C)	95°F (35°C)	Test Standard
Epoxy Classification	Types I, IV; Grade II (MV) <sup>1</sup>	Types I, IV; Grade I (LV) <sup>1</sup>		ASTM C881
Viscosity — mixed	3,600 cP	2,000 cP	750 cP	ASTM D2556
Gel Time — 60 gram mass	420 minutes	135 minutes	40 minutes	ASTM C881
Bond Strength, Slant Shear: Hardened to Hardened Concrete — 2-day cure Hardened to Hardened Concrete — 3-day cure Hardened to Hardened Concrete — 14-day cure	3,000 psi (20.7 MPa) <sup>2</sup> — —	— 1,375 psi (9.5 MPa) 1,500 psi (10.3 MPa)	1,300 psi (9.0 MPa) — —	ASTM C882
Tensile Strength — 7-day cure	7,100 psi (49.0 MPa)	8,000 psi (55.2 MPa)	8,300 psi (57.2 MPa)	ASTM D638
Elongation at Break — 7-day cure	2.52%	3.41%	3.21%	ASTM D638
Flexural Strength — 7-day cure	—	11,400 psi (78.6 MPa)	—	ASTM D790
Modulus of Elasticity in Compression — 7-day cure	345,000 psi (2,378.7 MPa)	349,000 psi (2,406.3 MPa)	365,000 psi (2,516.6 MPa)	ASTM D695
Heat Deflection Temperature — 7-day cure	—	122°F (50°C)	—	ASTM D648
Glass Transition Temperature — 7-day cure	—	135°F (57°C)	—	ASTM E1356
Water Absorption — 7-day cure <sup>3</sup>	—	0.07%	—	ASTM D570
Linear Coefficient of Shrinkage	—	0.001	—	ASTM D2556
Coefficient of Thermal Expansion	—	2.92 x 10 <sup>-5</sup> in./(in.°F) 5.26 x 10 <sup>-5</sup> cm/(cm°C)	—	ASTM C531
Shore D Hardness — 24-hour cure	—	78	—	ASTM D2240
Shore D Hardness — 7-day cure	—	80	—	ASTM D2240
Adhesion to Concrete — 24-hour cure	—	1,250 psi (8.8 MPa)	—	ASTM D7234

1. Installation under damp conditions 72°F – 110°F (22°C – 43°C).

2. Tested using dry test specimens.

3. Cured at 72°F (22°C), immersed in water 24 hours.

## CI-GV Gel-Viscosity Injection Epoxy

CI-GV structural injection epoxy gel is a two-component, high-modulus, high-solids, moisture-tolerant, thixotropic epoxy designed for pressure injection of concrete cracks. CI-GV is suitable for vertical and horizontal crack sealing and general concrete repair applications when substrate temperatures are between 40°F (4°C) to 90°F (32°C). Available in 3-gallon bulk kits or convenient side-by-side cartridges dispensed through a static mixing nozzle using either a manual or pneumatic dispensing tool.

### Features

- Chemically bonds with the concrete to provide a structural repair. CI-GV seals the crack from moisture, protecting rebar in the concrete from corrosion.
- Gel-viscosity moisture-tolerant, can be used on dry and damp surfaces
- Formulated for maximum penetration under pressure
- Non-shrink and resistant to oils, salts and mild chemicals
- Can be used with metered pressure-injection equipment
- Freeze-thaw resistant

### Applications

- Pressure injection
- Underwater pressure injection
- Repair mortar
- Bonding agent
- Pick proof sealant

### Product Information

Mix Ratio/Type	2:1
Mixed Color	Concrete gray
Crack Width	0.094" – 0.25" (2.4 mm – 6 mm)
Shelf Life	24 months
Storage Temperature	45°F (7°C) – 90°F (32°C)
Base Material Temperature	40°F (4°C) – 90°F (32°C)
Volatile Organic Compound (VOC)	10 g/L mixed
Yield	231 in. <sup>3</sup> /US gal. (0.001 m <sup>3</sup> /L)
Pot Life, 1 Quart	8 minutes at 90°F (32°C) 19 minutes at 72°F (22°C) 55 minutes at 50°F (10°C)
Thin Film (5 mil)	Set to touch: 3 hrs.
Cure Time at 72°F, ASTM D5895	Dry through: 6 hrs.
Manufactured in the USA using global materials	

### Code Reports, Standards and Compliance

ASTM C881 and AASHTO M235 Type I/II; Grade 3; Class B,  
Type I/IV and II/V, Grade 3, Class C

### Installation Instructions

Installation instructions are located at the following locations: pp. 224–229, product packaging or on the CI-GV Technical Data Sheet at [strongtie.com/rps](http://strongtie.com/rps).

### Accessories

See p. 223 for information on crack repair accessories.

### CI-GV Packaging Information

Model No.	Capacity (ounces)	Packaging Type	Package Quantity	Carton Quantity	Dispensing Tools	Mixing Nozzle
CIGV32	32	Side-by-side cartridge	1	5	ADT30S, ADT30P	EMN022 (included)
CIGV3KT	384	3 gallon bulk kit	1 case of (3) gallon cans	—	Metering pumps offered by third-party manufacturers	—

1. Cartridge estimation guidelines are available at [strongtie.com/apps](http://strongtie.com/apps).



CI-GV



# CI-GV Gel-Viscosity Injection Epoxy

## Technical Information

### Compressive Strength

Cure Time	40°F (4°C) psi (MPa)	60°F (16°C) psi (MPa)	72°F (22°C) psi (MPa)	90°F (32°C) psi (MPa)	Test Standard
4-hour cure	—	—	—	9,150 (63.1)	ASTM D695
8-hour cure	—	—	5,150 (35.5)	9,800 (67.6)	
16-hour cure	—	3,100 (21.4)	9,300 (64.1)	10,200 (70.3)	
24-hour cure	—	6,800 (46.9)	10,250 (70.7)	10,250 (70.7)	
3-day cure	5,100 (35.2)	10,500 (72.4)	11,250 (77.6)	10,250 (70.7)	
7-day cure	7,600 (52.4)	11,700 (80.7)	11,600 (80.0)	10,400 (71.7)	
14-day cure	8,300 (57.2)	12,150 (83.8)	11,600 (80.0)	10,600 (73.1)	
28-day cure	10,600 (73.1)	12,400 (85.5)	11,700 (80.7)	10,800 (74.5)	

Temperature Range	Class B 40°–60°F (4°C–16°C)	Class C >60°F (16°C)	Test Standard
Epoxy Classification	Types I, II; Grade 3	Types I, II, IV, V; Grade 3	ASTM C881
Gel Time — 60 gram mass <sup>1</sup>	200 minutes	30 minutes	ASTM C881
Bond Strength, Slant Shear: Hardened to Hardened Concrete — 2-day cure <sup>2</sup> Hardened to Hardened Concrete — 14-day cure <sup>2</sup> Fresh to Hardened Concrete — 14-day cure <sup>3</sup>	1,250 psi (8.6 MPa) 3,650 psi (25.2 MPa) 3,130 psi (21.6 MPa)	3,050 psi (21.0 MPa) 3,850 psi (26.5 MPa) 3,130 psi (21.6 MPa)	ASTM C882
Flexural Strength — 7-day cure <sup>2</sup>	4,400 psi (30.3 MPa)	10,150 psi (70.0 MPa)	ASTM D790
Modulus of Elasticity in Compression — 7-day cure <sup>2</sup>	389,000 psi (2,680 MPa)	454,000 psi (3,130 MPa)	ASTM D695
Heat Deflection Temperature — 7-day cure <sup>3</sup>	124°F (51°C)		ASTM D648
Glass Transition Temperature — 7-day cure <sup>3</sup>	136°F (58°C)		ASTM E1356
Water Absorption — 14-day cure <sup>4</sup>	0.31%		ASTM D570
Linear Coefficient of Shrinkage <sup>3</sup>	0.001		ASTM D2566
Coefficient of Thermal Expansion <sup>3</sup>	2.32 x 10 <sup>-5</sup> in./in.°F 4.18 x 10 <sup>-5</sup> cm/cm°C		ASTM C531
Shore D Hardness — 24-hour cure <sup>3</sup>	74		ASTM D2240
Shore D Hardness — 7-day cure <sup>3</sup>	80		ASTM D2240
Adhesion to Concrete — 24-hour cure <sup>3</sup>	1,100 psi (7.6 MPa)		ASTM D7234

1. Class B tested at 50°F (10°C), Class C tested at 72°F (22°C).
2. Class B cured at 40°F (4°C), Class C cured at 60°F (16°C).
3. Cured at 72°F (22°C).
4. Cured at 72°F (22°C), immersed in water 24 hours.

### Technical Information — When Used as a Mortar

Tests performed at 1 part by volume of mixed CI-GV to 1 part by volume of FX-702.  
Pot life: 30 minutes at 72°F (22°C).

### Compressive Strength

Cure Time	40°F (4°C) psi (MPa)	60°F (16°C) psi (MPa)	72°F (22°C) psi (MPa)	Test Standard
1-day cure	—	8,000 (55.2)	9,200 (63.4)	ASTM C579
7-day cure	8,600 (59.3)	9,500 (65.5)	10,200 (70.3)	
28-day cure	9,450 (65.2)	9,600i (66.2)	10,450 (72.0)	

Temperature Range	72°F (22°C) psi (MPa)	Test Standard
Flexural Strength — 7-day cure	4,050 (27.9)	ASTM C580
Tensile Strength — 7-day cure	2,000 (13.8)	ASTM C307
Bond Strength, Slant Shear Hardened to Fresh Mortar — 7-day cure	1,800 (12.4)	ASTM C882

## Crack-Pac® Injection Epoxy

The Crack-Pac injection epoxy is designed to repair cracks in concrete ranging from 1/64" to 1/4" wide in concrete walls, floors, slabs, columns and beams. The mixed adhesive has the viscosity of a light oil and a low surface tension, allowing it to penetrate fine to medium-width cracks in dry, damp or wet conditions with excellent results. Resin is contained in the cartridge and hardener is contained in the nozzle.

### Features

- Dispenses with a standard caulking tool, no special dispensing tool needed
- Clean and easy to mix
- Seals out moisture, protecting rebar in the concrete from corrosion and flooring from moisture damage
- Chemically bonds with the concrete to restore strength
- Non-shrink material resistant to oils, salts and mild chemicals
- Meets the requirements of AASHTO M235 and ASTM C881, Type I, Grade 1, Class C

### Application Considerations

- Suitable for repair of cracks ranging from 1/64" to 1/4" wide in concrete walls, floors, slabs, columns and beams
- Can be used to inject cracks in dry, damp or wet conditions with excellent results. Not for use in actively leaking cracks.
- In order for components to mix properly, the resin and hardener must be conditioned to 60°F (16°C) to 80°F (27°C) before mixing

**Shelf Life:** 24 months from date of manufacture, unopened

**Base Material Temperature:** 60°F (16°C) to 90°F (32°C)

**Storage Conditions:** For best results, store between 45°F (7°C) and 90°F (32°C)

**Installation Instructions:** See pp. 224–229

**Accessories:** See p. 223 for information on crack repair accessories.



**Crack-Pac Injection Epoxy (ETIPAC10)**



**Crack-Pac Kit (ETIPAC10KT)**

Crack-Pac injection epoxy is also available in the Crack-Pac Injection Kit (ETIPAC10KT). The kit includes everything needed to pressure inject cracks.

- 2 Crack-Pac cartridge/nozzle sets (ETIPAC10)
- 12 E-Z-Click injection ports
- 2 E-Z-Click injection fittings with 12" tubing
- 1 pint of ETR paste-over epoxy (8 oz. of resin + 8 oz. of hardener)
- 4 disposable wood paste-over applicators
- 1 pair latex gloves

**Crack-Pac®** Injection Epoxy

Property	Test Method	Results*
Viscosity	ASTM D2556	1,400 cP
Bond Strength (moist cure)	@ 2 days	2,010 psi (13.9 MPa)
	@ 14 days	3,830 psi (26.4 MPa)
Tensile Strength	ASTM D638	5,860 psi (40.4 MPa)
Tensile Elongation at Break	ASTM D638	14.0%
Compressive Yield Strength	ASTM D695	11,300 psi (77.9 MPa)
Compressive Modulus	ASTM D695	319,000 psi (2,200 MPa)
Flexural Strength	ASTM D790	8,020 psi (55.3 MPa)
Water Absorption (24-hour soak)	ASTM D570	0.08%
Linear Coefficient of Shrinkage	ASTM D2556	0.0020
Gel Time (60-gram mass)	ASTM C881	16 min.
Full, Mixed Cartridge	—	30 min.
Volatile Organic Compounds (VOC)	EPA Method 24 ASTM D2369	7 g/L
Initial Cure	—	24 hours
Mixing Ratio by Volume (Part A:Part B)	—	8:1

\*Material and curing conditions: 73 ± 2°F (23 ± 1°C)

## Crack-Pac Cartridge System

Model No.	Capacity (ounces)	Cartridge Type	Carton Quantity	Dispensing Tool
ETIPAC10	9	Single	12	CDT10S
ETIPAC10KT	18	Single	2 (kits)	

## Crack-Pac® Flex-H<sub>2</sub>O™ Polyurethane Crack Sealer

The Crack-Pac Flex-H<sub>2</sub>O polyurethane injection resin seals leaking cracks, voids or fractures from 1/32" to 1/4" wide in concrete or solid masonry. Designed to perform in applications where water is seeping or mildly leaking from the crack, the polyurethane is packaged in the cartridge and an accelerator is packaged in the nozzle. When the resin encounters water as it is injected into the crack, it becomes an expanding foam that provides a flexible seal in leaking and non-leaking cracks.

### Features

- Can be dispensed with a standard caulking tool
- Can also be used on dry cracks if water is introduced to affected area
- Can be used with a reduced amount or without accelerator to slow down reaction time
- Expands to fill voids and seal the affected area
- Fast reacting — reaction begins within 1 minute after exposure to moisture; expansion may be completed within 3 minutes (depending on the amount of moisture and the ambient temperature)
- 20:1 expansion ratio (unrestricted rise) means less material needed

### Application Considerations

- Suitable for sealing cracks ranging from 1/32" to 1/4" wide in concrete and solid masonry.
- Suitable for repair of cracks in dry, damp and wet conditions with excellent results. Designed to perform in applications where water is seeping or mildly leaking from the crack.
- In order for components to mix properly, the resin and hardener must be conditioned to 60°F (16°C) to 90°F (32°C) before mixing.

**Shelf Life:** 12 months from the date of manufacture, unopened

**Base Material Temperature:** 60°F (16°C) to 90°F (32°C)

**Storage Conditions:** For best results, store in a dry area between 45°F (7°C) and 90°F (32°C). Product is very moisture sensitive.

**Installation Instructions:** See pp. 224–229

**Accessories:** See p. 223 for information on crack repair accessories.



**Crack-Pac Flex-H<sub>2</sub>O  
Crack Sealer  
(CPFH09)**

# Crack-Pac® Flex-H<sub>2</sub>O™ Polyurethane Crack Sealer



**Crack-Pac Flex-H<sub>2</sub>O Kit (CPFH09KT)**

Crack-Pac Flex-H<sub>2</sub>O injection epoxy is also available in the Crack-Pac Flex-H<sub>2</sub>O Injection Kit (CPFH09KT). The kit includes everything needed to pressure inject cracks.

- 2 Crack-Pac Flex-H<sub>2</sub>O cartridge/nozzle sets (CPFH09)
- 12 E-Z-Click injection ports
- 2 E-Z-Click injection fittings with 12" tubing
- 1 pint of ETR paste-over epoxy (8 oz. of resin + 8 oz. of hardener)
- 4 disposable wood paste-over applicators
- 1 pair latex gloves

## Crack-Pac Flex-H<sub>2</sub>O Packaging

Model No.	Capacity	Cartridge Type	Carton Quantity	Dispensing Tool
CPFH09	9 ounces	Single	12	CDT10S
CPFH09KT	18 ounces	Single	2 (kits)	
FH05 <sup>1</sup>	5 gallons resin	Pail	1	—
	16 ounces catalyst			

1. For standard reaction time, use 30:1 resin to catalyst ration.  
For a faster reaction time, add more catalyst; for a slower reaction time, use less.

# CIP / ETR Paste-Over and Crack Sealants

CIP and ETR are fast-curing epoxy used to paste-over and seal cracks while securing injection ports to the surface of concrete substrates prior to injecting an epoxy or urethane crack repair product. When properly mixed, the products will be a uniform gray color and can be left in place or removed after the repair is complete.

## Features

- 1:1 two component, high solids, epoxy amine based adhesive
- Non-sag paste consistency for horizontal, vertical or overhead applications
- Manufactured in the USA using global materials

## CIP-LO Low Odor Paste-Over Epoxy and Crack Sealant

- Low odor formulation
- Strong substrate bond; requires chipping to remove
- Gel Time — 6 minutes at 72°F (22°C), 28 minutes at 40°F (4°C)
- Cure Time — 75 minutes at 72°F (22°C), 2 hours at 60°F (16°C) and 4–5 hours at 40°F (4°C)
- Volatile organic compound (VOC) — 4 g/L

## CIP-F Flexible Paste-Over Adhesive and Crack Sealant

- Remains flexible after cure for easier removal
- Moderate substrate bond; peels away for removal
- Gel Time — 4 minutes at 72°F (22°C), 9 minutes at 40°F (4°C)
- Cure Time — 1 hour at 72°F (22°C), and 3 hours at 40°F (4°C)
- Volatile organic compound (VOC) — 0 g/L

## ETR Concrete Repair and Paste-Over Epoxy

- Canisters are mixed manually and do not require dispensing tool
- Each package contains enough material to cover approximately eight lineal feet of cracks
- Gel Time — 6 minutes at 72°F (22°C), 10 minutes at 40°F (4°C)
- Cure Time — 1 hour at 72°F (22°C), 2 hours at 60°F (16°C)
- Volatile organic compound (VOC) — 7 g/L
- Available in two 8 fl. oz. canisters

## Application Considerations

- Apply to concrete 40°F (4°C) or above. For best results, warm material to 65°F (16°C) or above prior to application.

**Shelf Life:** 24 months from date of manufacture, unopened for CIP-LO and ETR; 12 months from date of manufacture, unopened for CIP-F

**Storage Conditions:** For best results, store between 45°F (7°C) and 90°F (32°C) for CIP-LO and ETR; 60°F (16°C) – 95°F (35°C) for CIP-F

**Installation Instructions:** See pp. 224–225



CIP-LO

CIP-F



ETR16

## Paste-Over and Crack Sealants

Model No.	Capacity (oz.)	Cartridge	Mixing Nozzle	Dispensing Tool	Package Quantity	Carton Quantity
CIPLO22	22	Side-by-side	EMN221	EDT22S, EDTA22CKT, EDTA22P	1	10
CIP-F22 <sup>1</sup>	22	Side-by-side	EMNCIPF22		1	10
ETR16	16	—	—	—	1	4

1. One EMNCIPF22 mixing nozzle is supplied with each cartridge.

# Crack Repair Accessories



**EMN022 Optimix®**  
Mixing Nozzle

## Mixing Nozzles

Model No.	Description	Package Quantity	Carton Quantity
EMNCIPF22-RP5	Mixing nozzle for CIPF-22 epoxy	5	5
EMN022-RP6	Optimix mixing nozzle for epoxies	6	5

1. Use only appropriate Simpson Strong-Tie® mixing nozzle in accordance with Simpson Strong-Tie instructions. Modification or improper use of mixing nozzle may impair epoxy performance.
2. Includes retaining nuts.



**E-Z-Click**  
Ports and Injection Fitting



**EIPX-EZ**  
Corner Mount/  
Drilled-In Port



**EIP-EZA**  
Flush-Mount Port

## Injection Ports and Injection Fittings

Model No.	Description	Hole Size (in.)	Package Contents		Carton Quantity
			Ports	E-Z Click Injection Fitting	
EIP-EZAKT	E-Z Click flush mount injection ports	—	20	1	5 kits
EIP-EZA		—	1 each	—	100
EIPX-EZKT	E-Z Click corner mount or drill in injection port	5/8	20	1	5 kits
EIPX-EZ-RP20			20	—	5 packs of 20
EIF-EZ	E-Z Click injection fitting	—	—	1 each	10

1. EIPX intended for use as a surface-mount port in corners and as a drilled-in port on flat surfaces.

Detailed information on the full line of Simpson Strong-Tie® manual and pneumatic dispensing tools is available on [strongtie.com](http://strongtie.com).

# Crack Injection Guide

**Important:** These instructions are intended as recommended guidelines. Due to the variability of field conditions, selection of the proper material for the intended application and installation is the sole responsibility of the applicator.

Epoxy injection is an economical method of repairing non-moving cracks in concrete walls, slabs, columns and piers and is capable of restoring the concrete to its pre-cracked strength. Prior to doing any injection it is necessary to determine the cause of the crack. If the source of cracking has not been determined and remedied, the concrete may crack again.

## Materials

- CI-LV and CI-SLV for repair of hairline cracks (0.002") and those up to 1/4" in width.
- CI-LV FS and CI-LPL for repair of fine to medium-width cracks (suggested width range: 1/64"-1/4").
- CI-GV for repair of medium-width cracks (suggested width range: 3/32"-1/4").
- Crack-Pac® injection epoxy for repair of fine to medium non-structural cracks (suggested width range: 1/64"-1/4").
- Crack-Pac Flex-H<sub>2</sub>O polyurethane crack sealer for repair of fine- to medium-width cracks (suggested width range: 1/32"-1/4").
- CIP-LO, CIP-F and ETR are recommended for paste-over of crack surface and installation of injection ports. ET-HP may also be used as a substitute.
- E-Z-Click™ injection ports, fittings and other suitable accessories.

## Estimating Guide for Epoxy Crack Injection

Width of Crack (in.)	Concrete Thickness (in.)	CI-SLV, CI-LV, CI-LV FS, CI-LPL, CI-GV	ETI-LV, ETI-GV	ETI-SLV	Crack-Pac	Crack-Pac Flex-H <sub>2</sub> O
		Approx. Coverage per 32 oz. Cartridge (linear ft.)	Approx. Coverage per 22 oz. Cartridge (linear ft.)	Approx. Coverage per 16.5 oz. Cartridge (linear ft.)	Approx. Coverage per 9 oz. Cartridge (linear ft.)	Approx. Coverage per 9 oz. Cartridge (linear ft.)
1/64	4	69.4	47.7	35.7	18.4	—
	6	46.3	31.8	23.8	12.3	—
	8	34.6	23.8	17.9	9.2	—
	10	27.8	19.1	14.3	7.4	—
1/32	4	34.6	23.8	17.9	9.2	108.0
	6	23.1	15.9	11.9	6.1	72.0
	8	17.3	11.9	8.9	4.6	54.0
	10	13.8	9.5	7.1	3.7	43.2
1/16	4	17.3	11.9	8.9	4.6	54.0
	6	11.5	7.9	6.0	3.1	36.0
	8	8.7	6.0	4.5	2.3	27.0
	10	7.0	4.8	3.6	1.8	21.6
1/8	4	8.7	6.0	4.5	2.3	27.0
	6	5.8	4.0	3.0	1.5	18.0
	8	4.4	3.0	2.2	1.2	13.5
	10	3.5	2.4	1.8	0.9	10.8
3/16	4	5.8	4.0	3.0	1.5	18.0
	6	3.8	2.6	2.0	1.0	12.0
	8	2.9	2.0	1.5	0.8	9.0
	10	2.3	1.6	1.2	0.6	7.2
1/4	4	4.4	3.0	2.2	1.2	13.5
	6	2.9	2.0	1.5	1.8	9.0
	8	2.2	1.5	1.1	0.6	6.8
	10	1.7	1.2	0.9	0.5	5.4

Coverage listed is approximate and will vary depending on waste and condition of concrete.



# Crack Injection Guide

## Preparation of the Crack for Injection

Clean the crack and the surface surrounding it to allow the paste-over to bond to sound concrete. At a minimum, the surface to receive paste-over should be brushed with a wire brush. Oil, grease or other surface contaminant must be removed in order to allow the paste-over to bond properly. Take care not to impact any debris into the crack during cleaning. Using clean, oil-free compressed air, blow out the crack to remove any dust, debris or standing water. Best results will be obtained if the crack is dry at the time of injection. If water is continually seeping from the crack, the flow must be stopped in order for epoxy injection to yield a suitable repair. Other materials such as polyurethane resins may be required to repair an actively leaking crack.

For many applications, additional preparation is necessary in order to seal the crack. Where a surfacing material has been removed using an acid or chemical solvent, prepare the crack as follows:

1. Using clean, compressed air, blow out any remaining debris and liquid.
2. Remove residue by high-pressure washing or steam cleaning.
3. Blow any remaining water from the crack with clean compressed air.

If a coating, sealant or paint has been applied to the concrete, it must be removed before placing the paste-over epoxy. Under the pressure of injection, these materials may lift and cause a leak. If the surface coating is covering the crack, it may be necessary to route out the opening of the crack in a "V" shape using a grinder in order to get past the surface contamination.

## Sealing of the Crack and Attachment of E-Z-Click™ Injection Ports

1. To adhere the port to the concrete, apply a small amount of paste-over around the bottom of the port base. Place the port at one end of the crack and repeat until the entire crack is ported. As a rule of thumb, injection ports should be placed 8" apart along the length of the crack.



**Important:** Do not allow paste-over to block the port or the crack under it, this is where epoxy must enter the crack.



2. Using a putty knife or other paste-over tool, generously work paste-over along the entire length of the crack. Take care to mound the paste-over around the base of the port to approximately ¼" thick extending 1" out from the base of the port and to work out any holes in the material. It is recommended that the paste-over should be a minimum of ¾" thick and 1" wide along the crack. Insufficient paste-over will result in leaks under the pressure of injection. If the crack passes completely through the concrete element, seal the back of the crack, if possible. If not, injection epoxy may be able to run out the back side of the crack, resulting in an ineffective repair.



3. Allow the paste-over to harden before beginning injection.

**Note:** CIP-LO and ETR are a fast cure and when manually mixed may harden prematurely if left in a mixed mass on the mixing surface while installing ports. Spreading paste-over into a thin film (approximately ⅛") on the mixing surface will slow curing by allowing the heat from the reaction to dissipate.

# Crack Injection Guide

## Injection Procedure for CI-SLV, CI-LV, CI-LV FS, CI-LPL, CI-GV and Crack-Pac® Injection Epoxy

1. Follow cartridge preparation instructions on the cartridge label. Verify the material flowing from the Opti-Mix® mixing nozzle is a uniform and consistent color.
2. Attach the E-Z-Click™ fitting to the end of the nozzle by pushing the tubing over the barbs at the end of the nozzle. Make sure that all ports are pushed in to the open position.
3. Attach the E-Z-Click™ injection fitting to the first E-Z-Click™ port until it clicks into place. Make sure that the heads of all the ports are pushed in to the open position. In vertical applications, begin injection at the lowest port and work your way up. In a horizontal application start at one end of the crack and work your way to the other end.

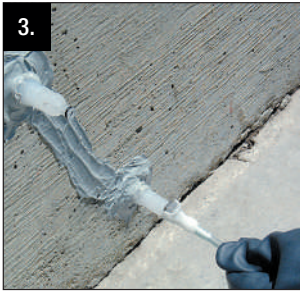

4. Inject epoxy into the first port until it will no longer flow into the crack. If epoxy shows at the next port and the first port still accepts material, close the second port and continue to inject into the first port until it accepts no more epoxy. Continue closing ports where epoxy appears until the first port refuses epoxy. When the first port reaches the point of refusal, brace the base of the port and pull out gently on the head of the port to close it. Pulling too hard may dislodge the port from the surface of the concrete, causing a leak. Depress the metal tab on the head of the E-Z-Click fitting and remove it from the port.

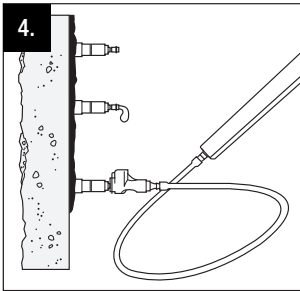

5. Go to the last port where epoxy appeared while injecting the first port, open it, and continue injection at this port. If the epoxy has set up and the port is bonded closed, move to the next clean port and repeat the process until every portion of the crack has refused epoxy.

While this method may appear to leave some ports uninjected, it provides maximum pressure to force the epoxy into the smaller areas of the crack. Moving to the next port as soon as epoxy appears will allow the epoxy to travel along the wider parts of the crack to the next ports rather than force it into the crack before it travels to the next ports.

## Injection Tips

- If using a pneumatic dispensing tool, set the tool at a low setting when beginning injection and increase pressure if necessary to get the epoxy to flow.
- For narrow cracks it may be necessary to increase the pressure gradually until the epoxy begins to flow. It may also be necessary to wait a few minutes for the epoxy to fill the crack and travel to the next port.
- If desired, once the injection epoxy has cured, remove the injection ports and paste-over. Epoxy paste-over can be removed with a chisel, scraper, or grinder. The paste-over can be simply peeled off if CIP-F is used. Using a heat gun to soften the epoxy is recommended when using a chisel or scraper.
- Mixing nozzles can be used for multiple cartridges as long as the epoxy does not harden in the nozzle. For injection epoxies in side-by-side cartridges, care must be taken to ensure the level of material is the same on both parts of the cartridge. This can be done by checking for air in the cartridge and the positions of the wipers in the back of the cartridge. If the liquid levels are off by more than 1/8", then Step 1 from the injection procedures must be repeated.

# Crack Injection Guide

## Troubleshooting

### Epoxy is flowing into the crack, but not showing up at the next port.

This can indicate that either the crack expands and/or branches off under the surface of the concrete. Continue to inject and fill these voids. In situations where the crack penetrates completely through the concrete element and the backside of the concrete element cannot be sealed (e.g., basement walls, or footings with backfill) longer injection time may not force the epoxy to the next port. This most likely indicates that epoxy is running out of the unsealed back side of the crack. In this case the application may require a gel viscosity injection epoxy (CI-GV) or may not be suitable for epoxy injection repair without excavation and sealing of the back side of the crack.

### Epoxy is leaking from the pasted-over crack or around injection ports.

Stop injecting. If using a fast cure paste-over material (CIP-F, CIP-LO or ETR), wipe off the leaking injection epoxy with a cotton cloth and re-apply the paste over material. Wait approximately 10 to 15 minutes to allow the paste-over to begin to harden. If the leak is large (e.g., the port broke off of the concrete surface) it is a good idea to wait approximately 30 minutes, or longer as necessary, to allow the paste over to cure more completely. Check to see that the paste-over is hard before reinjecting or the paste-over or ports may leak. Another option for small leaks is to clean off the injection epoxy and use paraffin or crayon to seal the holes.

### More epoxy is being used than estimated.

This may indicate that the crack either expands or branches off below the surface. Continue to inject and fill these voids. This may also indicate that epoxy is running out of the back side of the crack. If the crack penetrates completely through the concrete element and cannot be sealed, the application may not be suitable for injection repair.

### Back pressure is preventing epoxy from flowing.

This can indicate several situations:

- The crack is not continuous and the portion being injected is full (see above instructions about injection after the port has reached refusal).
- The port is not aligned over the crack properly.
- The crack is blocked by debris.
- The injection epoxy used has too high a viscosity.
- If the mixing nozzle has been allowed to sit for a few minutes full of epoxy, the material may have hardened in the nozzle. Attach the E-Z-Click™ fitting to a port at another uninjected location on the crack and attempt to inject. If the epoxy still won't flow, chances are the epoxy has hardened in the nozzle.

### Less epoxy is being used than estimated.

This may indicate that the crack is shallower than originally thought, or the epoxy is not penetrating the crack sufficiently before moving to the next port. Reinject some ports with a lower viscosity epoxy to see if the crack will take more epoxy. Another option is to heat the epoxy to a temperature of 80-100°F which will reduce its viscosity and allow it to penetrate into small cracks easier. The epoxy should be heated uniformly, do not overheat cartridge.

# Crack Injection Guide

## Injection Procedure for Crack-Pac® Flex-H<sub>2</sub>O™ Crack Sealer

1. Follow cartridge preparation instructions on the cartridge label. Verify that the material flowing from the nozzle is a uniform green color.
2. Attach the E-Z-Click™ fitting to the end of the nozzle by pushing the tubing over the barbs at the end of the nozzle. Make sure that all ports are pushed into the open position. If crack is dry, introduce a small amount of water (1–2 mL) into each open port using a dropper, pipet, syringe or squirt bottle.
3. Attach the E-Z-Click injection fitting to the first E-Z-Click port until it clicks into place. Make sure that the head of the port is pushed into the open position. In vertical applications, begin injection at the lowest port and work your way up. In a horizontal application, start at one end of the crack and work your way to the other end.
4. Inject polyurethane into the first port until material shows at the next port. Remove the E-Z-Click fitting by bracing the base of the port and pulling out gently on the head of the port to close it. Pulling too hard may dislodge the port from the surface of the concrete, causing a leak. Depress the metal tab on the head of the E-Z-Click fitting and remove it from the port.
5. Move to the next port and repeat until all ports have been injected.

## Injection Tips for Crack-Pac Flex-H<sub>2</sub>O Crack Sealer

- For narrow cracks, it may be necessary to increase the pressure gradually until the polyurethane begins to flow. It may also be necessary to wait a few minutes for the material to fill the crack and travel to the next port.
- If desired, once the injection epoxy has cured, remove the injection ports and paste-over. Epoxy paste-over can be removed with a chisel, scraper, or grinder. The paste-over can be simply peeled off if CIP-F is used. Using a heat gun to soften the epoxy is recommended when using a chisel or scraper.

## Troubleshooting for Crack-Pac Flex-H<sub>2</sub>O Crack Sealer

### Polyurethane is flowing into the crack, but not showing up at the next port.

This can indicate there is not enough water present to react with the polyurethane and generate foam. Introduce water into the port and continue to inject. Introduce water into subsequent ports prior to injection. This can indicate that either the crack expands and/or branches off under the surface of the concrete. Continue to inject and fill these voids. This can indicate that the crack either expands and/or branches off under the surface of the concrete. Continue to inject and fill these voids. In situations where the crack penetrates completely through the concrete element, and the back-side of the concrete element cannot be sealed (e.g., basement walls, or footings with backfill), longer injection time may not force the epoxy to the next port. This most likely indicates that epoxy is running out the unsealed back side of the crack. In this case, the application may require a gel viscosity injection epoxy (CI-GV) or may not be suitable for injection repair without excavation and sealing of the back side of the crack.

### Back pressure is preventing polyurethane from flowing.

This can indicate several situations:

- The crack is not continuous and the portion being injected is full.
- The port is not aligned over the crack properly.
- The crack is blocked by debris.

### Polyurethane is leaking from the pasted-over crack or around injection ports.

Stop injecting. If using a fast cure paste-over material (CIP-F, CIP-LO or ETR), wipe off the leaking polyurethane with a cotton cloth and reapply the paste over material. Wait a approximately 10–15 minutes to allow the paste-over to begin to harden. If the leak is large (e.g., the port broke off of the concrete surface), it is a good idea to wait approximately 30 minutes, or longer as necessary, to allow the paste-over to cure more completely. Check to see that the paste-over is hard before reinjecting or the paste-over or ports may leak.

Another option for small leaks is to clean off the injection adhesive and use paraffin or crayon to seal the holes.

# Crack Injection Guide

## Troubleshooting for Crack-Pac Flex-H<sub>2</sub>O Crack Sealer (cont.)

### More polyurethane is being used than estimated.

This may indicate there is not enough water present to react with the polyurethane and generate foam. Introduce water into the port and continue to inject. Introduce water into subsequent ports prior to injection. This may indicate that the crack either expands or branches off below the surface. Continue to inject and fill these voids.

### Less polyurethane is being used than estimated.

This may indicate that the crack is shallower than originally thought, or the polyurethane is not penetrating the crack sufficiently before moving to the next port.

---

## Gravity-Feed Procedure

Some horizontal applications where complete penetration is not a requirement can be repaired using the gravity-feed method.

1. Follow cartridge preparation instructions on the cartridge label. Verify that the material flowing from the Optimix® mixing nozzle is a uniform and consistent color.
2. Starting at one end of the crack, slowly dispense epoxy into the crack, moving along the crack as it fills. It will probably be necessary to do multiple passes in order to fill the crack. It is possible that the epoxy will take some time to run into the crack, and the crack may appear empty several hours after the initial application. Reapply epoxy until the crack is filled.
3. In situations where the crack completely penetrates the member (e.g., concrete slab), the material may continue to run through the crack into the subgrade. It may be possible to use a small amount of course, dry sand to act as a barrier for the injection epoxy. Place the sand in the crack to a level no more than ¼" thickness of the member and apply the injection epoxy as described in step 2. The epoxy level will drop as it penetrates the sand, but should cure and provide a seal to the bottom of the crack. Reapply the epoxy until the crack is filled. In some cases, application of sand is impractical or not permitted and epoxy repair may not provide a complete and effective repair. Use of a gel viscosity injection epoxy (GI-GV) may permit a surface repair to the crack with partial penetration.

# Heli-Tie™ Helical Wall Tie

The Heli-Tie helical wall tie is a stainless-steel tie used to anchor building façades to structural members or to stabilize brick walls.

The helical design allows the tie to be driven quickly and easily into a predrilled pilot hole (or embedded into mortar joints in new construction) to provide a mechanical connection between a masonry façade and its backup material. As it is driven, the fins of the tie undercut the masonry to provide an expansion-free anchorage that will withstand tension and compression loads.

The Heli-Tie wall tie is installed into a predrilled hole using a proprietary setting tool with an SDS-plus® shank rotohammer to drive and countersink the tie. Heli-Tie wall ties perform in concrete and masonry as well as wood and steel studs.

## Features

- Installs quickly and easily — with the rotohammer in hammer mode, the tie installs faster than competitive products.
- Provides an inconspicuous repair that preserves the appearance of the building. After installation, the tie is countersunk up to ½" below the surface, allowing the tie location to be patched.
- Larger core diameter provides higher torsional capacity, resulting in less deflection due to “uncoiling” under load.
- Fractionally sized anchor — no metric drill bits required.
- Patented manufacturing process results in a more uniform helix along the entire tie, allowing easier driving and better interlock with the substrate.

**Material:** Type 304 stainless steel (Type 316 available by special order — contact Simpson Strong-Tie for details)

**Test Criteria:** CSA A370

## Installation

- Drill pilot hole through the façade material and into the backup material to the specified embedment depth + 1" using appropriate drill bit(s) in the chart below. Drill should be in rotation-only mode when drilling into soft masonry or into hollow backing material.
- Position blue end of the Heli-Tie fastener in the installation tool and insert the tie into the pilot hole.
- With the SDS-plus rotohammer in hammer mode, drive the tie until the tip of the installation tool enters the exterior surface of the masonry and countersinks the tie below the surface. Patch the hole in the façade with a matching masonry mortar.



Heli-Tie Helical Wall Tie



Watch how to install Heli-Tie helical wall tie at [strongtie.com/helitie](http://strongtie.com/helitie).

## Installation Sequence

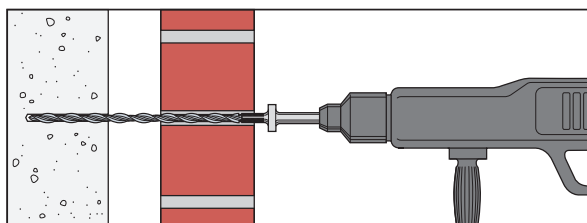
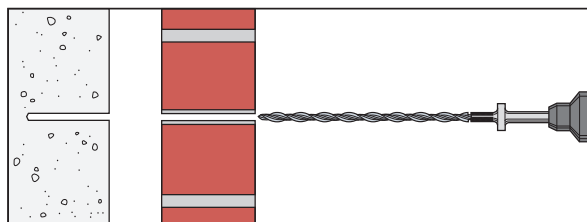
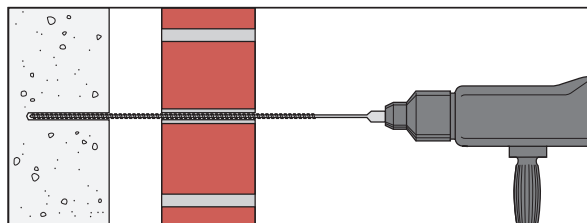

## Heli-Tie Helical Wall Tie Product Data

Size (in.)	Model No.	Drill Bit Diameter (in.)	Quantity	
			Box	Carton
¾ x 7	HELI37700A	7/32 or ¼	50	400
¾ x 8	HELI37800A		50	400
¾ x 9	HELI37900A		50	400
¾ x 10	HELI371000A		50	200
¾ x 11	HELI371100A		50	200
¾ x 12	HELI371200A		50	200
¾ x 14	HELI371400A		50	200
¾ x 16	HELI371600A		50	200
¾ x 18	HELI371800A		50	200
¾ x 20	HELI372000A		50	200

Special-order lengths are also available; contact Simpson Strong-Tie for details.

# Heli-Tie™ Design Information

## Guide Tension Loads in Various Base Materials

Size in. (mm)	Base Material	Anchor Location	Drill Bit Diameter in.	Min. Embed. Depth in. (mm)	Tension Load <sup>1</sup>		
					Ultimate <sup>2</sup> lb. (kN)	Load at Max. Permitted Displ. <sup>3</sup> lb. (kN)	Standard Deviation lb. (kN)
3/8 (9.0)	Solid brick <sup>4</sup>	Mortar bed joint	7/32	3 (76)	570 (2.5)	240 (1.1)	79 (0.4)
			1/4		365 (1.6)	130 (0.6)	46 (0.2)
		Brick face	7/32		1,310 (5.8)	565 (2.5)	84 (0.4)
			1/4		815 (3.6)	350 (1.6)	60 (0.3)
	Hollow brick <sup>5</sup>	Mortar bed joint	7/32		530 (2.4)	285 (1.3)	79 (0.4)
			7/32		775 (3.4)	405 (1.8)	47 (0.2)
		Brick face	1/4		510 (2.3)	185 (0.8)	20 (0.1)
	Grout-filled CMU <sup>6</sup>	Center of face shell	7/32		2 3/4 (70)	1,170 (5.2)	405 (1.8)
			1/4	830 (3.7)		350 (1.6)	60 (0.3)
		Web	7/32	1,160 (5.2)		440 (2.0)	56 (0.2)
			1/4	810 (3.6)		330 (1.5)	100 (0.4)
		Mortar bed joint	7/32	720 (3.2)		320 (1.4)	71 (0.3)
			1/4	530 (2.4)		205 (0.9)	58 (0.3)
	Hollow CMU <sup>7</sup>	Center of face shell	7/32	790 (3.5)	305 (1.4)	56 (0.2)	
			1/4	505 (2.2)	255 (1.1)	46 (0.2)	
		Web	7/32	1,200 (5.3)	445 (2.0)	50 (0.2)	
			1/4	675 (3.0)	385 (1.7)	96 (0.4)	
	Normal-weight concrete <sup>8</sup>	—	7/32	1 3/4 (44)	880 (3.9)	410 (1.8)	76 (0.3)
			1/4	2 3/4 (70)	990 (4.4)	380 (1.7)	96 (0.4)
	2x4 wood stud <sup>9,11</sup>	Center of thin edge	7/32	2 3/4 (70)	590 (2.6)	370 (1.6)	24 (0.1)
1/4			450 (2.0)		260 (1.2)	6 (0.0)	
Metal stud <sup>10,11</sup>	Center of flange	7/32	1 (25)	200 (0.9)	120 (0.5)	8 (0.0)	
		1/4		155 (0.7)	95 (0.4)	2 (0.0)	

**Caution:** Loads are guide values based on laboratory testing. Onsite testing shall be performed for verification of capacity since base material quality can vary widely.

1. Tabulated loads are guide values based on laboratory testing. Onsite testing shall be performed for verification of capacity since base material quality can vary widely.
2. Ultimate load is average load at failure of the base material. Heli-Tie fastener average ultimate steel strength is 3,885 lb. and does not govern.
3. Load at maximum permitted displacement is average load at displacement of 0.157 inches (4 mm). The designer shall apply a suitable factor of safety to these numbers to derive allowable service loads.
4. Solid brick values for nominal 4-inch-wide solid brick conforming to ASTM C62/C216, Grade SW, Type N mortar is prepared in accordance with IBC Section 2103.2.
5. Hollow brick values for nominal 4-inch-wide hollow brick conforming to ASTM C216/C652, Grade SW, Type HBS, Class H40V. Mortar is prepared in accordance with IBC Section 2103.2.
6. Grout-filled CMU values for nominal 8-inch-wide lightweight, medium-weight and normal-weight concrete masonry units. The masonry units must be fully grouted. Values for nominal 8-inch-wide concrete masonry units (CMU) with a minimum specified compressive strength of masonry,  $f'_m$ , at 28 days is 1,500 psi.
7. Hollow CMU values for 8-inch-wide lightweight, medium-weight and normal-weight concrete masonry units.
8. Normal-weight concrete values for concrete with minimum specified compressive strength of 2,500 psi.
9. 2x4 wood stud values for nominal 2x4 Spruce-Pine-Fir.
10. Metal stud values for 20-gauge C-shape metal stud.
11. For retrofits, due to difficulty of locating center of 2x4 or metal stud flange, install Heli-Tie from interior of building.
12. For new construction, anchor one end of tie into backup material. Embed other end into veneer mortar joint.

# Heli-Tie™ Design Information

## Compression (Buckling) Loads<sup>1</sup>

Size in. (mm)	Unsupported Length in. (mm)	Ultimate Compression Load <sup>1</sup> lb. (kN)
3/8 (9.0)	1 (25)	1,905 (8.5)
	2 (50)	1,310 (5.8)
	4 (100)	980 (4.4)
	6 (150)	785 (3.5)

1. The designer shall apply a suitable factor of safety to these numbers to derive allowable service loads.

### Heli-Tie Fastener Installation Tool — Model HELITool37A

Required for correct installation of Heli-Tie wall ties. Speeds up installation and automatically countersinks the tie into the façade material.



HELITool37A

### Heli-Tie Wall Tie Tension Tester — Model HELITEST37A

Recommended equipment for onsite testing to accurately determine load values in any specific structure, the Heli-Tie wall tie tension tester features a key specifically designed to grip the Heli-Tie fastener and provide accurate results. Replacement test keys sold separately (Model HELIKEY37A).

Contact Simpson Strong-Tie for Heli-Tie onsite testing procedures.



HELITEST37A



HELIKEY37A

For more information see [strongtie.com/helitie](http://strongtie.com/helitie).



# Heli-Tie™ Helical Stitching Tie

The Simpson Strong-Tie® Heli-Tie helical stitching tie provides a unique solution to the preservation and repair of damaged brick and masonry structures. Ties are grouted into existing masonry joints to repair cracks and increase strength with minimum disturbance. Made of Type 304 stainless steel, the Heli-Tie stitching tie features radial fins formed on the steel wire via cold rolling process, increasing the tensile strength of the tie.



**HELIST254000**

## Features

- Helical design distributes loads uniformly over a large surface area
- Installs into the mortar joint to provide an inconspicuous repair and preserve the appearance of the structure
- Type 304 stainless steel offers superior corrosion resistance to mild steel reinforcement
- Patented manufacturing process results in consistent, uniform helix configuration (US Patent 7,269,987)
- Batch number printed on each tie for easy identification and inspection

**HELIST254000:** ¼" x 40" stitching tie  
(special lengths are available upon request)

**Material:** Type 304 stainless steel

**Ordering Information:** Sold in tubes of 10

## Installation Instructions

- Chase bed joint 20" on either side of the affected area to a depth of approximately 1 ¼" with a rotary grinding wheel. Vertical spacing of installation sites should be 12" for red brick or "every other course" for concrete masonry units.
- Clear bed joint of all loose debris.
- Mix non-shrink repair grout or mortar per product instructions and place into the prepared bed joint, filling the void to approximately two-thirds of its depth. Simpson Strong-Tie FX-263 Rapid-Hardening Vertical / Overhead Repair Mortar should be used.
- Embed the tie at one-half the depth of the void. Trowel displaced grout to fully encapsulate the tie.
- Fill any remaining voids and vertical cracks with non-shrink repair grout or other repair mortar to conceal repair site.



Watch how to install Heli-Tie helical stitching tie at [strongtie.com/helitie](http://strongtie.com/helitie).

## Installation Sequence

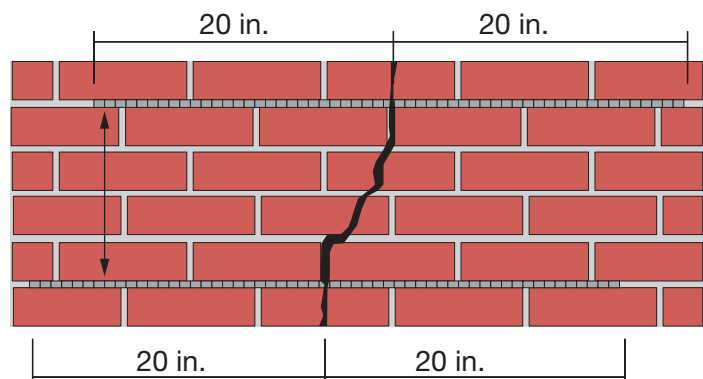
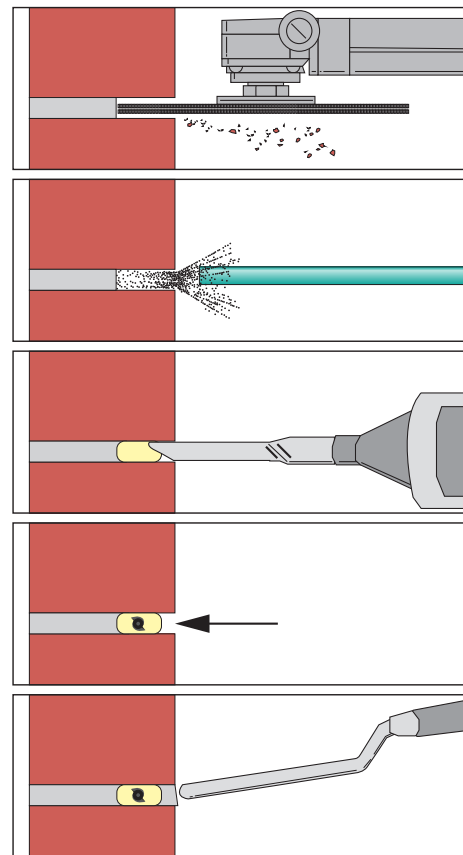

# Carbide Drill Bits

---





# Speed Clean™ DXS / SDS-plus® Drill Bits

Speed Clean DXS Dust Extraction Drill Bits  
Code Tested with AT-XP®, SET-XP® and SET-3G™ Adhesives

Diameter (in.)	Shank Style	Drilling Depth (in.)	Overall Length (in.)	Model No.
7/16	SDS-plus – 2 cutter	7 1/2	13	DXS-PL04313
1/2	SDS-plus – 2 cutter	7 1/2	13	DXS-PL05013
9/16	SDS-plus – 2 cutter	10	15	DXS-PL05615
5/8	SDS-plus – 4 cutter	10	15	DXS-PL06215Q
11/16	SDS-plus – 4 cutter	12 1/2	18	DXS-PL06818Q
3/4	SDS-plus – 4 cutter	12 1/2	18	DXS-PL07518Q
3/4	SDS-max® – 4 cutter	12 1/2	21	DXS-MX07521Q
13/16	SDS-max – 4 cutter	15	25	DXS-MX08125Q
7/8	SDS-max – 4 cutter	15	25	DXS-MX08725Q
1	SDS-max – 4 cutter	17 1/2	27	DXS-MX10027Q
1 1/8	SDS-max – 4 cutter	20	29	DXS-MX11229Q
1 3/8	SDS-max – 4 cutter	25	34	DXS-MX13734Q



Carbide Drill Bits

## SDS-plus Shank Bits — Retail Packs

Diameter (in.)	Drilling Depth (in.)	Overall Length (in.)	Quantity (per pack)	Model No.
5/32	4	6 1/4	25	MDPL01506-R25
3/16	2	4 1/4	25	MDPL01804-R25
	4	6 1/4	25	MDPL01806-R25
	6	8 1/4	25	MDPL01808-R25
	8	10	25	MDPL01810-R25
	10	12	25	MDPL01812-R25
	12	14	25	MDPL01814-R25
7/32	4	6 1/4	25	MDPL02106-R25
	6	8 1/4	25	MDPL02108-R25
	8 3/4	11	25	MDPL02111-R25
1/4	2	4 1/4	25	MDPL02504-R25
	4	6 1/4	25	MDPL02506-R25
	6	8 1/4	25	MDPL02508-R25
	8 3/4	11	25	MDPL02511-R25
5/16	4	6 1/4	25	MDPL03106-R25
3/8	4	6 1/4	25	MDPL03706-R25
	10	12 1/4	25	MDPL03712-R25
1/2	4	6 1/4	25	MDPL05006-R25
	10	12 1/4	25	MDPL05012-R25
5/8	6	8	20	MDPL06208-R20



SDS-plus  
Retail Packs

# SDS-plus® / SDS-max® Drill Bits

## SDS-plus Shank Bit

SDS-plus bits use an asymmetrical-parabolic flute for efficient energy transmission and dust removal.

### SDS-plus Shank Bits

Diameter (in.)	Drilling Depth (in.)	Overall Length (in.)	Model No.
5/32	2	4 1/4	MDPL01504
	4	6 1/4	MDPL01506
3/16	4	6 1/4	MDPL01806
	6	8 1/4	MDPL01808
	8	10	MDPL01810
	10	12	MDPL01812
	12	14	MDPL01814
7/32	4	6 1/4	MDPL02106
	6	8 1/4	MDPL02108
	8 3/4	11	MDPL02111
1/4	14	16	MDPL02116
	2	4 1/4	MDPL02504
	4	6 1/4	MDPL02506
	6	8 1/4	MDPL02508
1/4	9	11	MDPL02511
	12	14	MDPL02514
	14	16	MDPL02516
	5/16	4	6 1/4
10		12	MDPL03112
3/8	4	6 1/4	MDPL03706
	8	10 1/4	MDPL03710
	10	12 1/4	MDPL03712
	16	18	MDPL03718
	22	24	MDPL03724
7/16	4	6 1/4	MDPL04306
	10	12 1/4	MDPL04312
1/2	4	6 1/4	MDPL05006
	8	10 1/4	MDPL05010
	10	12 1/4	MDPL05012
	16	18	MDPL05018
	22	24	MDPL05024
9/16	4	6 1/4	MDPL05606
	10	12 1/4	MDPL05612
	16	18	MDPL05618
5/8	6	8	MDPL06208
	10	12	MDPL06212
	16	18	MDPL06218
	22	24	MDPL06224
1 1/16	6	8	MDPL06808
3/4	6	8	MDPL07508
	8	10	MDPL07510
	10	12	MDPL07512
	16	18	MDPL07518
	22	24	MDPL07524
7/8	6	8	MDPL08708
	10	12 1/4	MDPL08712
	16	18	MDPL08718
1	8	10	MDPL10010
	16	18	MDPL10018



SDS-plus Shank Bit

### SDS-max and SDS-max Quad Head Shank Bits

Diameter (in.)	Drilling Depth (in.)	Overall Length (in.)	Model No.
3/8	7 1/2	13	MDMX03713
1/2	7 1/2	13	MDMX05013
	15 1/2	21	MDMX05021
9/16	7 1/2	13	MDMX05613
	15 1/2	21	MDMX05621
5/8	7 1/2	13	MDMX06213Q
	15 1/2	21	MDMX06221Q
	30 1/2	36	MDMX06236Q
1 1/16	15 1/2	21	MDMX06821Q
3/4	8	13	MDMX07513Q
	17	21	MDMX07521Q
	31	36	MDMX07536Q
13/16	17	21	MDMX08121Q
7/8	8	13	MDMX08713Q
	17	21	MDMX08721Q
1	8	13	MDMX10013Q
	17	21	MDMX10021Q
	31	36	MDMX10036Q
1 1/16	18	23	MDMX10623Q
1 1/8	12	17	MDMX11217Q
	17	21	MDMX11221Q
	31	36	MDMX11236Q
1 3/16	18	23	MDMX11823Q
1 1/4	10	15	MDMX12515Q
	18	23	MDMX12523Q
	31	36	MDMX12536Q
1 3/8	12	17	MDMX13717Q
	18	23	MDMX13723Q
1 1/2	18	23	MDMX15023Q
1 3/4	18	23	MDMX17523Q
2	18	23	MDMX20023Q

Model numbers ending with "Q" denote Quad Head.



SDS-max Shank Bit

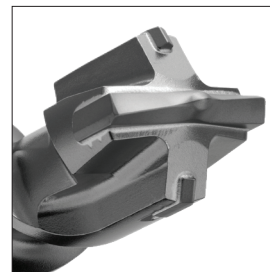

**Quad Head**  
Model numbers ending with "Q" denote quad-head bits.

Carbide Drill Bits

# Spline Shank / Straight Shank Drill Bits

Carbide Drill Bits

## Spline Shank Bits

Diameter (in.)	Drilling Depth (in.)	Overall Length (in.)	Model No.
3/8	8	13	MDSP03713
	11	16	MDSP03716
7/16	8	13	MDSP04313
1/2	8	13	MDSP05013
	11	16	MDSP05016
	17	22	MDSP05022
	31	36	MDSP05036
9/16	8	13	MDSP05613
	18	23	MDSP05623
5/8	8	13	MDSP06213
	11	16	MDSP06216 (Q)
	17	22	MDSP06222 (Q)
	31	36	MDSP06236 (Q)
11/16	11	16	MDSP06816
3/4	8	13	MDSP07513
	11	16	MDSP07516 (Q)
	17	22	MDSP07522 (Q)
	31	36	MDSP07536 (Q)
7/8	11	16	MDSP08716 (Q)
	17	22	MDSP08722 (Q)
	31	36	MDSP08736
1	11	16	MDSP10016
	17	22	MDSP10022 (Q)
	31	36	MDSP10036 (Q)
1 1/8	11	16	MDSP11216Q
	17	22	MDSP11222 (Q)
1 1/4	17	22	MDSP12522 (Q)
	31	36	MDSP12536Q
1 3/8	17	22	MDSP13722 (Q)
1 1/2	17	22	MDSP15022 (Q)
1 3/4	17	22	MDSP17522
2	17	22	MDSP20022

(Q) – Denotes quad head availability



Spline Shank Bit

## Straight Shank Bits

Diameter (in.)	Drilling Depth (in.)	Overall Length (in.)	Model No.
1/8	1 3/8	3	MDB01203
3/16	4	6	MDB01806
1/4	2 1/8	4	MDB02504
	4	6	MDB02506
	10	12	MDB02512
5/16	4	6	MDB03106
3/8	4	6	MDB03706
	10	12	MDB03712
7/16	4	6	MDB04306
1/2	4	6	MDB05006
	10	12	MDB05012
5/8	3 1/2	6	MDB06206
3/4	4	6	MDB07506



Straight Shank Bit

## Straight Shank Bits – Retail Packs

Diameter (in.)	Drilling Depth (in.)	Overall Length (in.)	Quantity (per pack)	Model No.
3/16	4	6	25	MDB01806-R25
1/4	2 1/8	4	25	MDB02504-R25
	4	6	25	MDB02506-R25
5/16	4	6	25	MDB03106-R25
3/8	4	6	25	MDB03706-R25
1/2	4	6	25	MDB05006-R25

Straight Shank Bits Retail Packs



## Core Bits

Simpson Strong-Tie® core bits are made to the same exacting standards as our standard carbide-tipped drill bits. They utilize a centering bit to facilitate accurate drilling in combination hammer/drill mode.

### Core Bits with Centering Bit – SDS-max® Shank

Diameter (in.)	Drilling Depth (in.)	Overall Length (in.)	Model No.
2	6 1/4	22	CBMX20022
2 5/8	6 1/4	22	CBMX26222
3 1/8	6 1/4	22	CBMX31222
3 1/2	6 1/4	22	CBMX35022
4	6 1/4	22	CBMX40022
5	6 1/4	22	CBMX50022

**Note:** With 1-piece bits, once coring is begun, the centering bit must be removed using ejector pin. Core bit bodies are 2 1/16" deep.



Core Bit Transfers Energy Efficiently



Core Bit Center Pilot Bit (CTRBTf04304)



Ejector Key (CDBEJKEY)

# Demolition Bits

## Flat Chisels

General Concrete and Masonry Demolition

Shank Type	Head Width (in.)	Overall Length (in.)	Model No.
SDS-max®	1	12	CHMXF10012
	1	18	CHMXF10018
Spline	1	12	CHSPF10012
	1	18	CHSPF10018



Flat Chisel

## Bull Point Chisels

General Concrete and Masonry Demolition

Shank Type	Overall Length (in.)	Model No.
SDS-plus®	10	CHPLBP10
SDS-max	12	CHMXBP12
	18	CHMXBP18
Spline	12	CHSPBP12
	18	CHSPBP18



Bull-Point Chisel

## Asphalt Cutters

Asphalt, Hardpan and Compacted Soil Cutting

Shank Type	Head Width (in.)	Overall Length (in.)	Model No.
SDS-max	3½	16	CHMXAC35016
¾" Hex	3½	16	CHHAC35016



Asphalt Cutter

## Ground Rod Drivers

Driving in Ground Rods

Shank Type	Head Width (in.)	Overall Length (in.)	Model No.
SDS-max	7/8	10¼	CHMXRD08710
Spline	7/8	10¼	CHSPRD08710



Ground Rod Driver

## Scrapers

Removing Tiles, Flooring and Other Materials

Shank Type	Head Width (in.)	Overall Length (in.)	Model No.
SDS-plus	¾	10	CHPLF07510
	1½	10	CHPLSC15010
SDS-max	2	12	CHMXSCP20012
Spline	2	12	CHSPSCP20012



Scraper

## Scalers

Removing Large Quantities of Material

Shank Type	Head Width (in.)	Overall Length (in.)	Model No.
SDS-max	1½	12	CHMXSC15012
	2	12	CHMXSC20012
	3	12	CHMXSC30012
Spline	2	12	CHSPSC20012
	3	12	CHSPSC30012



Scaler

## Bushing Tools One Piece

Concrete and Asphalt Surface Roughening

Shank Type	Head Width (in.)	Overall Length (in.)	Model No.
SDS-max	1¾	9½	CHMXBT17509
Spline	1¾	9¼	CHSPBT17509



Bushing Tool Head

Carbide Drill Bits

C-A-2021 © 2021 SIMPSON STRONG-TIE COMPANY INC.

For additional carbide product availability, visit [strongtie.com](http://strongtie.com) or see the current product guide (S-A-PG).

# Appendix



Conservare il prodotto in un luogo asciutto e al riparo dal sole.  
Vedre les overföreskrifter ytterligare på verslo. GÄLDER  
HORS DE LA PORTEE DES ENFANTS.

[www.strongtie.com](http://www.strongtie.com)



## Appendix

# Market Segments and Applications



Light-Frame Construction

pp. 242–243

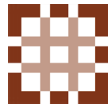

Retrofit and Repair

pp. 244–245



Wastewater / Water Treatment

pp. 246–247



Bridge and Marine

pp. 248–249



Manufacturing, Maintenance and Material Handling (OEM)

pp. 250–251



Cold-Formed Steel Construction

pp. 252–253

# Supplemental Topics for Anchors

I. Anchor Products for Corrosive Environments . . . . .	254–259
II. Base Materials . . . . .	260
III. Anchor Failure Modes . . . . .	260–261
IV. Corrosion Resistance . . . . .	261–262
V. Mechanical Anchors . . . . .	263
VI. Adhesive Anchors . . . . .	264–269

**Light Frame Construction**



**Anchoring Adhesives**



SET-3G™



AT-XP®



SET-XP®



ET-HP®

**Mechanical Anchors**



Titen HD®



Titen HD® SS



Titen HD®  
Washer Head



Strong-Bolt® 2



Wedge-All®



Titen Turbo™

**Direct Fastening Systems**



Powder-Actuated Systems



PDPawl



PDPA

## Light Frame Construction

### Speed Clean™ DXS



### Carbide Drill Bits



### Framing Hardware (New and Retrofit)



Titen HD®, Strong-Bolt® 2, Wedge-All®, Titen HD rod coupler, anchoring adhesives

### Ledgers



Titen HD SS (exterior), Titen HD (interior), Strong-Bolt 2, Wedge-All, anchoring adhesives

### Post Bases for Decks, Railings and Patio Covers



Titen HD SS, Strong-Bolt 2, Wedge-All, anchoring adhesives

**Retrofit and Repair**



**Anchoring Adhesives**



SET-3G™



AT-XP®



SET-XP®



ET-HP®

**CI Structural Injection Epoxy**



Available in five formulations (CI-SLV, CI-LV, CI-LV FS, CI-LPL and CI-GV) for cracks ranging from 0.002" to 1/4" (0.05 mm to 6.4 mm).



Opti-Mesh Screen Tube



Steel Screen Tube



Piston Plug

**Mechanical Anchors**



Titen HD®



Titen HD®  
SS



Titen HD®  
CS



Titen HD®  
CS SS



Strong-Bolt® 2



Strong-Bolt® 2  
SS



Wedge-All®



Wedge-All®  
SS



Sleeve-All



Sleeve-All  
SS



Titen  
Turbo™



Drop-In



Drop-In SS



Hollow Drop-In



Heli-Tie™



FX-225



FX-263

# Retrofit and Repair

## Composite Strengthening Systems™ (CSS)

FRP, FRCM, Laminate, FRP Anchors, Saturant/Paste, Coatings

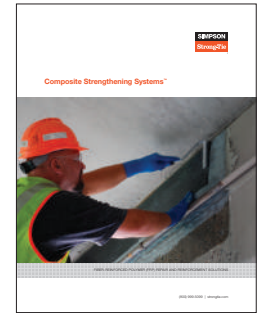

## Rebar and Smooth Dowelling



Anchoring adhesives

## Seismic Retrofit / Structural Renovation



Titen HD®, Strong-Bolt® 2, Wedge-All®, anchoring adhesives

## Architectural Attachments



Titen HD, Strong-Bolt 2, Wedge-All, Titen Turbo™, anchoring adhesives

## Concrete Formwork



Titen HD, DSD, Strong-Bolt 2, Wedge-All

## Concrete / Unreinforced Masonry (URM) Retrofit



CSS laminates and CSS-EP



Carbon and E-glass FRP Fabrics



Fabric-Reinforced Cementitious Matrix (FRCM)

**Wastewater / Water Treatment**



For more information, please visit [strongtie.com/solutions/wastewater](http://strongtie.com/solutions/wastewater).

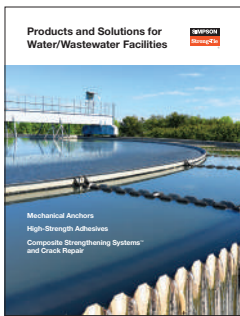

Flier S-A-WWT

**Anchoring Adhesives**



SET-3G™

AT-XP®

SET-XP®

ET-HP®

**Mechanical Anchors**



Titen HD® SS

Titen HD®  
CS SS

Strong-Bolt® 2 SS

Wedge-All® SS

Sleeve-All SS

Drop-In SS

Appendix

**Crack Injection**



Crack-Pac® Flex-H<sub>2</sub>O™

**CI Structural Injection Epoxy**



Available in five formulations (CI-SLV, CI-LV, CI-LV FS, CI-LPL and CI-GV) for cracks ranging from 0.002" to 1/4" (0.05 mm to 6.4 mm).



FX-70-9™  
Epoxy Coating

**Wastewater / Water Treatment**

**Composite Strengthening Systems™ (CSS)**

FRP, FRCM, Laminate, FRP Anchors, CSS-ES, Underwater Saturant, Paste, Coatings

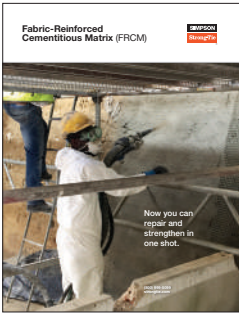

**Crack Injection – Paste-Over and Crack Sealants**



CIP-LO

CIP-F22

ETR-16

**Speed Clean™ DXS**



**Carbide Drill Bits**



**Pumps and Equipment**



Titen HD® SS, Strong-Bolt® 2 SS, Wedge-All® SS, anchoring adhesives

**Concrete / Unreinforced Masonry (URM) Retrofit**



CSS laminates and CSS-EP

**Gates**



Titen HD SS, Strong-Bolt 2 SS, Wedge-All SS, anchoring adhesives

**Pipe Supports**



Titen HD, Titen HD threaded rod hanger, Strong-Bolt 2, Wedge-All, Drop-In

**Bridge and Marine**



**Anchoring Adhesives**



SET-3G™ AT-XP® SET-XP® ET-HP®

**CI Structural Injection Epoxy**



Available in five formulations (CI-SLV, CI-LV, CI-LV FS, CI-LPL and CI-GV) for cracks ranging from 0.002" to 1/4" (0.05 mm to 6.4 mm).

**Mechanical Anchors**



Titen HD® SS Titen HD® CS SS Strong-Bolt® 2 SS Wedge-All® SS Sleeve-All SS Drop-In SS

**Composite Strengthening Systems™ (CSS)**

FRP, FRCM, Laminate, FRP Anchors, CSS-ES, Underwater Saturant, Paste, Coatings



FX-70®



FX-70-6MP



FX-763





# Bridge and Marine

## Concrete Formwork



Titen HD® SS, Strong-Bolt® 2 SS, Wedge-All® SS

## Heavy- and Light-Duty Signs



Titen HD SS, Strong-Bolt 2 SS, Wedge-All SS, anchoring adhesives

## Dowels for Jersey Barriers



Anchoring adhesives

## Pile Repair



FX-70® structural piling repair and protection system

## Barriers and Guardrails



Titen HD SS, Strong-Bolt 2 SS, Wedge-All SS, anchoring adhesives

## Attaching Precast Elements

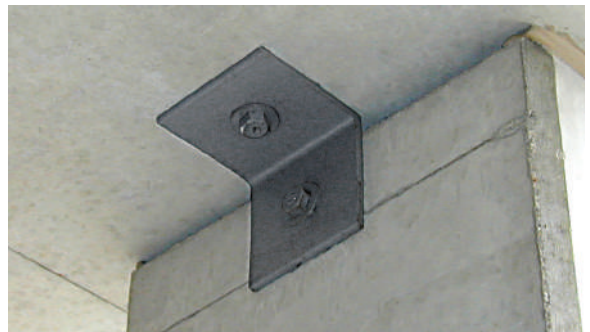

Titen HD SS, Strong-Bolt 2 SS, Wedge-All SS, anchoring adhesives

## Glare Screens



Titen HD SS, Strong-Bolt 2 SS, Wedge-All SS, anchoring adhesives

## Composite Strengthening Systems™ (CSS)



Underwater and marine coatings

C-A-2021 © 2021 SIMPSON STRONG-TIE COMPANY INC.



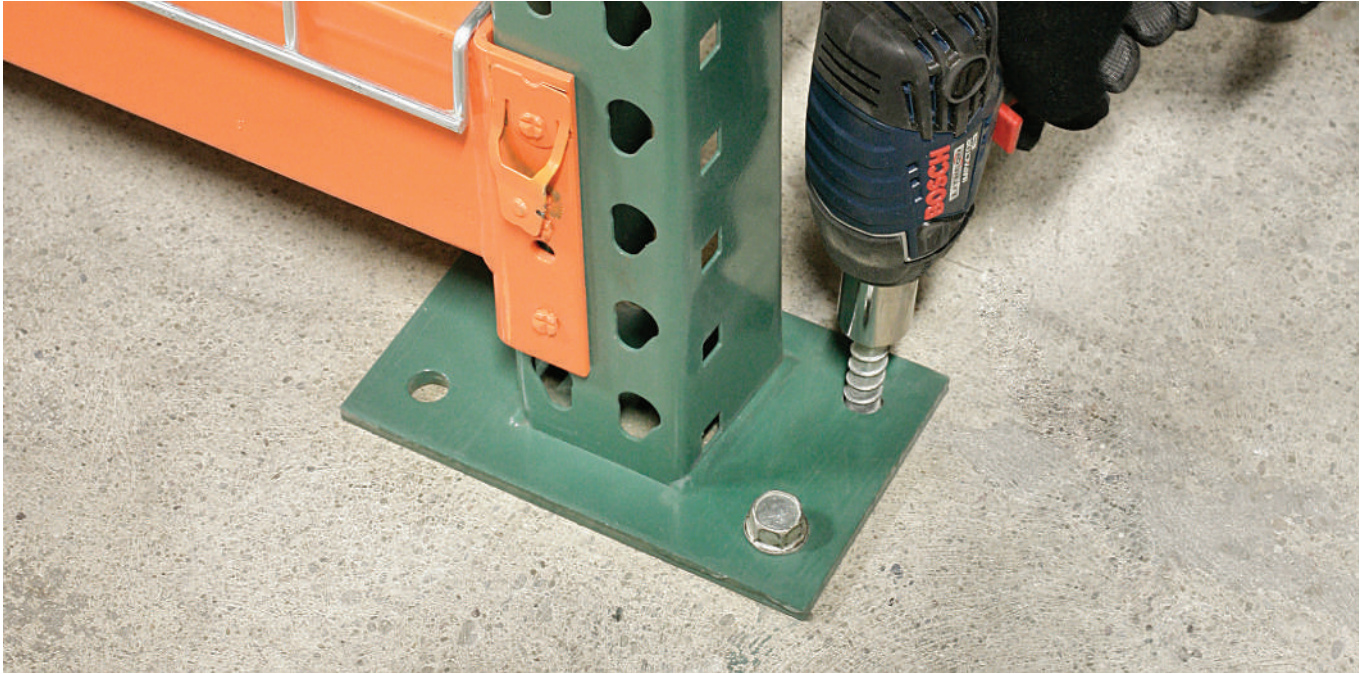

### Anchoring Adhesives



SET-3G™



AT-XP®



SET-XP®



ET-HP®

### Mechanical Anchors



Titen HD®



Titen HD® SS



Titen HD® CS



Strong-Bolt® 2



Strong-Bolt® 2 SS



Wedge-All®



Wedge-All® SS



Titen Turbo™

# Manufacturing, Maintenance and Material Handling (OEM)

## Racking



Titen® HD, Strong-Bolt® 2, Wedge-All®

## Dock Doors and Bumpers



Titen HD SS, Strong-Bolt 2 SS, Wedge-All SS, anchoring adhesives

## Conveyors and Rollers



Titen HD, Strong-Bolt 2, Wedge-All, anchoring adhesives

## Steel Beams / Columns



Titen HD, Strong-Bolt 2, Wedge-All, anchoring adhesives

## Stadium Seating



Titen HD, Strong-Bolt 2, Wedge-All, anchoring adhesives

## Awnings



Titen HD, Strong-Bolt 2, Wedge-All, anchoring adhesives

# Cold-Formed Steel Construction

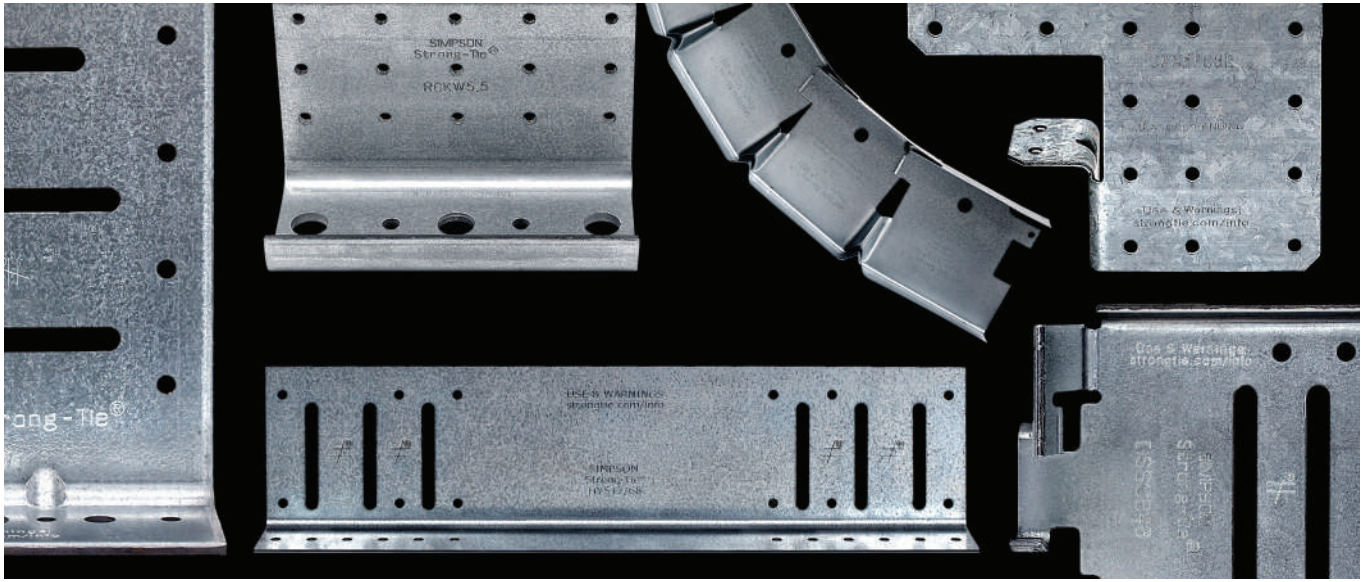

## Mechanical Anchors



## Direct Fastening Systems

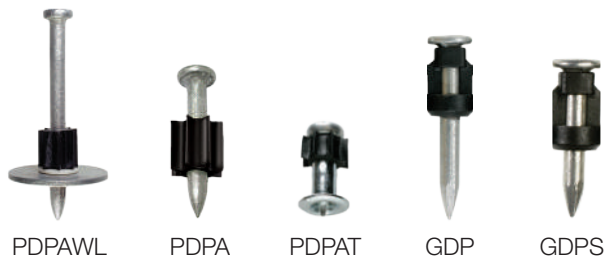

# Cold-Formed Steel Construction

## CFS Curtain Walls



## Bypass Steel Connections



Direct fastening systems

## Bottom Track



Split-Drive, Crimp Drive®, Zinc Nailon™, direct fastening systems

## Low-Post or Knee-Wall Framing



RCKW kneewall connection with Titen HD, Strong-Bolt 2 or anchoring adhesives

## Concrete Floor Slab

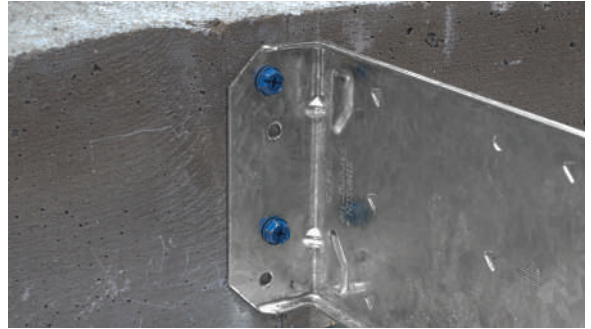

Titen Turbo™ screw

## Bypass Connections (Concrete or Steel)

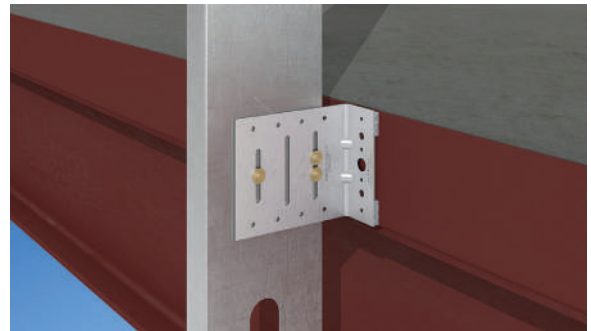

Titen HD®, Strong-Bolt® 2, Wedge-All® to concrete and direct fastening systems to steel

## Ceiling Track



Split-Drive, Crimp Drive, Zinc Nailon, direct fastening systems

## Bypass Floor Slab or Steel Attachment

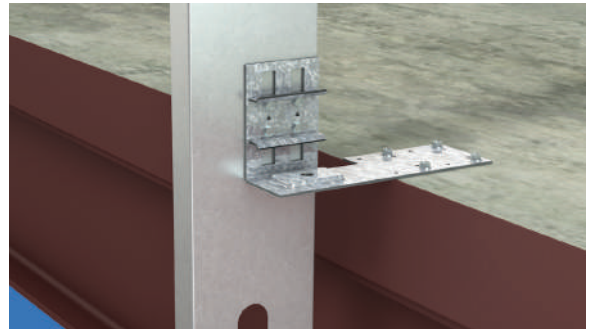

Titen HD to concrete and direct fastening systems to steel

## Supplemental Topics for Anchors

### I. Anchor Products for Corrosive Environments



Trusted quality, code approved and innovative stainless-steel anchors that can be installed in exterior and corrosive environments.

When it comes to anchorage, specifying a material that can withstand the environment is critical. Proper protection comes from materials that are capable of resisting corrosion while maintaining their strength.

Most anchor products are made from carbon steel. This material is easy to form into a screw or an expansion anchor and can be heat treated to increase its strength and durability. Steel is versatile but can weaken in a corrosive environment. Left unprotected, the iron in the steel will react with oxygen and moisture to form iron oxide — also known as rust.

#### Environments

There are four levels of corrosive environments (as shown below).

#### Minimum Corrosion Resistance Recommendations

Corrosion Resistance Classification by Environment	Recommended Product Material or Coating
Low	Zinc plated
Medium	Mechanically galvanized (ASTM B695 — Class 55)
	Hot-dip galvanized (ASTM A153 — Class C)
High	Type 303 or 304 stainless steel
Severe	Type 316 stainless steel

## Supplemental Topics for Anchors

### Quick Guide to Choosing the Right Stainless-Steel Grade

#### High to Severe

A highly corrosive environment is a location where anchors are exposed to chemicals such as fertilizers, soil, acid rain and other corrosive elements. Examples of these environments include kitchens, industrial zones, food-processing facilities, wineries, breweries, outdoor facilities and severe exterior conditions.



Typical high-corrosive environment — central utility plants.



Typical high-corrosive environment — food-processing plants.



Typical severe-corrosive environment — wastewater treatment plants.

#### Medium

A medium-level corrosive environment is typically a general exterior location where chlorides or corrosive chemical elements are not present. Anchors installed in interior conditions where the anchor is attaching a treated lumber may also require a medium-level corrosive-resistant anchor. Examples of elements at risk to medium-exposure corrosion are stadium seating, exterior handrails, exterior facade anchorages and other components of outdoor facilities.



Typical medium exposure — outdoor seating.



Typical medium-corrosive environment — exterior anchorage.

#### Low

Finally, low-corrosive environments consist of interior dry spaces. Examples of such applications are warehouse racking, machinery installations, facility catwalk anchorage, interior furniture anchorages and so forth.



Typical low-corrosive environment — interior warehouse.

## Supplemental Topics for Anchors

Type 304, 316 and 410 stainless steel products for your job.

Anchor — Stainless-Steel Products	Type 304	Type 316	Type 410
Drop-In (DIA) internally threaded anchor	✓	✓	
Sleeve-All® sleeve anchor	✓		
Stainless-steel Titen HD® heavy-duty screw anchor	✓	✓	
Strong-Bolt® 2 wedge anchor	✓	✓	
Titen® stainless-steel concrete and masonry screw			✓
Wedge-All® wedge anchor	✓	✓	

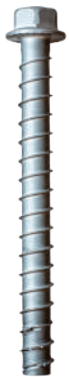

**Stainless-Steel Titen HD**  
Heavy-Duty  
Screw Anchor



**Stainless-Steel Titen HD Countersunk**  
Heavy-Duty  
Screw Anchor



**Strong-Bolt 2**  
Wedge Anchor



**Wedge-All**  
Wedge Anchor



**Sleeve-All**  
Sleeve Anchor



**Drop-In (DIA)**  
Internally  
Threaded Anchor



**Stainless-Steel Titen**  
Concrete and  
Masonry Screw



## Supplemental Topics for Anchors

### Concrete Adhesives for Stainless-Steel Threaded Rod



#### SET-3G™ High-Strength Epoxy Adhesive

- Install in dry, water-saturated or water-filled holes in base materials with temperatures between 40°F and 100°F
- NSF/ANSI standard 61 approved



#### SET-XP® High-Strength Epoxy Adhesive

- AC308 qualified for threaded rods, development length and lap splices
- NSF/ANSI standard 61 approved



#### AT-XP® High-Strength, Fast-Cure, All-Weather Acrylic Adhesive

- Can be used in cold temperatures as low as 14°F
- NSF/ANSI standard 61 approved

Adhesive Anchor — Stainless Steel Rods	ASTM A193, Grade B8 and B8M (Type 304 and 316)	ASTM A593 CW (Type 304 and 316)	ASTM A193, Grade B6 (Type 410)
SET-3G	✓	✓	✓
SET-XP	✓		✓
AT-XP	✓		✓

## Supplemental Topics for Anchors

When designing strong and durable anchorage solutions for high and severe corrosive environments, the two most commonly considered materials are Types 304 and 316 stainless steel.

Type 300 Series stainless-steel screw anchors have different corrosion-resistant properties for different environments. When matched to the appropriate environment and application, anchors made from Type 300 Series stainless steel will resist the effects of corrosion and maintain their strength and integrity. Type 316 is the optimal choice for applications in severe corrosive or extreme environments such as salt water, or when chemical or corrosive solutions are present. Type 304 is a cost-effective solution for high corrosive applications where the environment may be wet, moist or damp.

### Type 316 Stainless Steel

- Wastewater treatment
- Fertilizer storage buildings
- Sill plates in coastal environments
- Marine/port restoration
- Light rail (transportation)
- Agricultural facilities
- Pulp and paper mills
- Parking structures
- Tunnels
- Balconies in coastal environments
- Outdoor railings in coastal environments

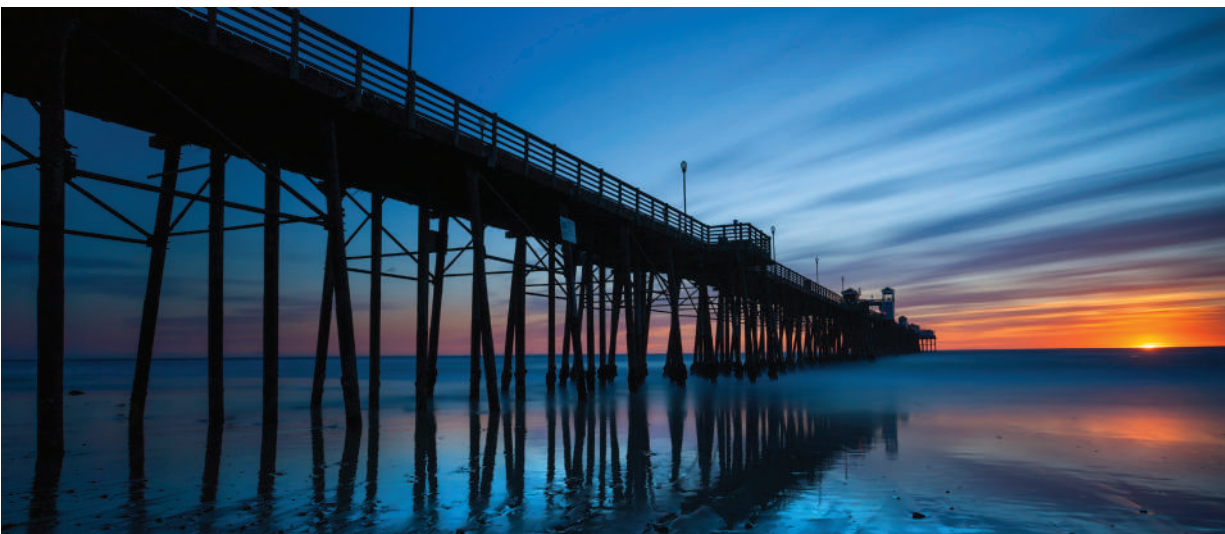

## Supplemental Topics for Anchors

### Type 304 Stainless Steel

- Stadium seating
- Curtain walls
- Clean rooms
- Central utility plant facilities
- Food-processing facilities
- Ledger bolts for decks
- DOT signs and fixtures
- Cooling towers
- Scaffolding
- Parking structures
- Balconies
- Refineries
- Breweries and wineries
- Fencing
- Outdoor railings



## Supplemental Topics for Anchors

### II. Base Materials

“Base material” is a generic industry term that refers to the element or substrate to be anchored to. Base materials include concrete, brick, concrete block (CMU) and structural tile, to name a few. The most common type of base material where adhesive and mechanical anchors are used is concrete.

#### Concrete

Concrete can be cast-in-place or precast concrete. Concrete has excellent compressive strength, but relatively low tensile strength. Cast-in-place (or sometimes called “poured in place”) concrete is placed in forms erected on the building site. Cast-in-place concrete can be either normal-weight or lightweight concrete. Lightweight concrete is often specified when it is desirable to reduce the weight of the building structure.

Lightweight concrete differs from normal-weight concrete by the weight of aggregate used in the mixture. Normal-weight concrete has a unit weight of approximately 150 pounds per cubic foot compared to approximately 115 pounds per cubic foot for lightweight concrete.

The type of aggregate used in concrete can affect the tension capacity of an adhesive anchor. Presently, the relationship between aggregate properties and anchor performance is not well understood. Test results should not be assumed to be representative of expected performance in all types of concrete aggregate.

Prefabricated concrete is also referred to as “precast concrete”. Precast concrete can be made at a prefabricating plant or site-cast in forms constructed on the job. Precast concrete members may be solid or may contain hollow cores. Many precast components have thinner cross sections than cast in place concrete. Precast concrete may use either normal or lightweight concrete. Reinforced concrete contains steel bars, cable, wire mesh or random glass fibers. The addition of reinforcing material enables concrete to resist tensile stresses which lead to cracking.

The compressive strength of concrete can range from 2,000 psi to over 20,000 psi, depending on the mixture and how it is cured. Most concrete mixes are designed to obtain the desired properties within 28 days after being cast.

#### Concrete Masonry Units (CMU)

Block is typically formed with large hollow cores. Block with a minimum 75% solid cross section is called solid block even though it contains hollow cores. In many parts of the country building codes require steel reinforcing bars to be placed in the hollow cores, and the cores to be filled solid with grout.

In some areas of the eastern United States, past practice was to mix concrete with coal cinders to make cinder blocks. Although cinder blocks are no longer made, there are many existing buildings where they can be found. Cinder blocks require special attention as they soften with age.

#### Brick

Clay brick is formed solid or with hollow cores. The use of either type will vary in different parts of the United States. Brick can be difficult to drill and anchor into. Most brick is hard and brittle. Old, red clay brick is often very soft and is easily over-drilled. Either of these situations can cause problems in drilling and anchoring. The most common use of brick today is for building facades (curtain wall or brick veneer) and not for structural applications. Brick facade is attached to the structure by the use of brick ties spaced at intervals throughout the wall. In older buildings, multiple widths, or “wythes” of solid brick were used to form the structural walls. Three and four wythe walls were common wall thicknesses.

#### Clay Tile

Clay tile block is formed with hollow cores and narrow cavity wall cross sections. Clay tile is very brittle, making drilling difficult without breaking the block. Caution must be used in attempting to drill and fasten into clay tile.

### III. Anchor Failure Modes

Four different tension failure modes and three different shear failure modes are generally observed for post-installed anchors under tension loading.

#### Failure Modes

Tension	Shear
Steel Fracture Concrete Breakout Pullout (Mechanical Anchor) Bond Failure (Adhesive Anchor)	Steel Fracture Concrete Breakout Pryout

**Breakout Failure** — Breakout failure occurs when the base material ruptures, often producing a cone-shaped failure surface when anchors are located away from edges, or producing a spall when anchors are located near edges. Breakout failure can occur for both mechanical and adhesive anchors and is generally observed at shallower embedment depths, and for installations at less than critical spacings or edge distances.

**Pullout Failure** — Pullout failure occurs when a mechanical anchor pulls out of the drilled hole, leaving the base material otherwise largely intact.

## Supplemental Topics for Anchors

**Bond Failure** — Bond failure occurs when an adhesive anchor pulls out of the drilled hole due to an adhesion failure at the adhesive-to-base-material interface, or when there is a cohesive failure within the adhesive itself. When bond failure occurs, a shallow cone-shaped breakout failure surface will often form near the base material surface. This breakout surface is not the primary failure mechanism.

**Pryout Failure** — Pryout failure occurs for shallowly embedded anchors when a base material failure surface is pried out “behind” the anchor, opposite the direction of the applied shear force.

**Steel Fracture** — Steel fracture occurs when anchor spacings, edge distances and embedment depths are great enough to prevent the base-material-related failure modes listed above and the steel strength of the mechanical anchor or adhesive anchor insert is the limiting strength.

## IV. Corrosion Resistance

Many environments and materials can cause corrosion, including ocean salt air, fire-retardants, fumes, fertilizers, preservative-treated wood, de-icing salts, dissimilar metals and more. Metal fixtures, fasteners and anchors can corrode and lose load-carrying capacity when installed in corrosive environments or when installed in contact with corrosive materials.

The many variables present in a building environment make it impossible to accurately predict if, or when, corrosion will begin or reach a critical level. This relative uncertainty makes it crucial that specifiers and users are knowledgeable about the potential risks and select a product suitable for the intended use. It is also prudent that regular maintenance and periodic inspections are performed, especially for outdoor applications.

It is common to see some corrosion in outdoor applications. Even stainless steel can corrode. The presence of some corrosion does not mean that load capacity has been affected or that failure is imminent. If significant corrosion is apparent or suspected, then the fixtures, fasteners and connectors should be inspected by a qualified engineer or qualified inspector. Replacement of affected components may be appropriate.

### Chemical Attack

Chemical attack occurs when the anchor material is not resistant to a substance with which it is in contact. Chemical-resistance information regarding anchoring adhesives is found on pp. 268–269. Some wood-preservative chemicals and fire-retardant chemicals and retentions pose increased corrosion potential and are more corrosive to steel anchors and fasteners than others. Additional information on this subject is available at [strongtie.com](http://strongtie.com).

We have attempted to provide basic knowledge on the subject of corrosion here, but it is important to fully educate yourself by reviewing our technical bulletins on the topic ([strongtie.com/info](http://strongtie.com/info)) and also by reviewing information, literature and evaluation reports published by others.

### Galvanic Corrosion

Galvanic corrosion occurs when two electrochemically dissimilar metals contact each other in the presence of an electrolyte (such as water) that acts as a conductive path for metal ions to move from the more anodic to the more cathodic metal. In the galvanic couple, the more anodic metal will corrode preferentially. The Galvanic Series of Metals table provides a qualitative guide to the potential for two metals to interact galvanically. Metals in the same group (see table) have similar electrochemical potentials. The farther the metals are apart on the table, the greater the difference in electrochemical potential, and the more rapidly galvanic corrosion will occur. Corrosion also increases with increasing conductivity of the electrolyte.

Good detailing practice, including the following, can help reduce the possibility of galvanic corrosion of anchors:

- Use of anchors and metals with similar electrochemical potentials
- Separating dissimilar metals with insulating materials
- Ensuring that the anchor is the cathode, when dissimilar materials are present
- Preventing exposure to and pooling of electrolytes.

### Hydrogen-Assisted Stress-Corrosion Cracking

Some hardened fasteners may experience premature failure if exposed to moisture as a result of hydrogen-assisted stress-corrosion cracking. These fasteners are recommended specifically for use in dry, interior locations.

Galvanic Series of Metals

<b>Corroded End (Anode)</b>
Magnesium Magnesium alloys Zinc
Aluminum 1100 Cadmium Aluminum 2024-T4 Iron and Steel
Lead Tin Nickel (active) Inconel Ni-Cr alloy (active) Hastelloy alloy C (active)
Brasses Copper Cu-Ni alloys Monel
Nickel (passive)
304 stainless steel (passive) 316 stainless steel (passive) Hastelloy alloy C (passive)
Silver Titanium Graphite Gold Platinum
<b>Protected End (Cathode)</b>

# Supplemental Topics for Anchors

## Guidelines for Selecting Corrosion-Resistant Anchors and Fasteners

### Evaluate the Application

Consider the importance of the connection.

### Evaluate the Exposure

Consider these moisture and treatment chemical exposure conditions:

- **Dry Service:** Generally INTERIOR applications and includes wall and ceiling cavities, raised floor applications in enclosed buildings that have been designed to prevent condensation and exposure to other sources of moisture. Prolonged exposure during construction should also be considered, as this may constitute a Wet Service or Elevated Service Condition.
- **Wet Service:** Generally EXTERIOR construction in conditions other than Elevated Service. These include Exterior Protected and Exposed and General Use Ground Contact as described by the AWWA UC4A.
- **Elevated Service:** Includes fumes, fertilizers, soil, some preservative-treated wood (AWPA UC4B and UC4C), industrial zones, acid rain and other corrosive elements.
- **Uncertain:** Unknown exposure, materials or treatment chemicals.
- **Ocean/Water Front:** Marine environments that include airborne chlorides and some splash. Environments with de-icing salts are included.
- **Treatment Chemicals:** See AWWA Use Category Designations. The preservative-treated wood supplier should provide all of the pertinent information about the wood being used. The information should include Use Category Designation, wood species group, wood treatment chemical and chemical retention. See appropriate evaluation reports for corrosion effects of treatment chemicals and fastener corrosion resistance recommendations.

### Use the Simpson Strong-Tie® Corrosion Classification Table

If the treatment chemical information is incomplete, Simpson Strong-Tie recommends the use of a 300-series stainless-steel product. Also if the treatment chemical is not shown in the Corrosion Classification Table, then Simpson Strong-Tie has not evaluated it and cannot make any recommendations other than the use of coatings and materials in the Severe category. Manufacturers may independently provide test results of other product information; Simpson Strong-Tie expresses no opinion regarding such information.

### Minimum Corrosion Resistance Recommendations

Corrosion Resistance Classification	Material or Coating
Low	ZN
	Zinc plated
Medium	Ceramic coating
	Mechanically galvanized (ASTM B695 – Class 65)
	Mechanically galvanized (ASTM B695 – Class 55) <sup>1</sup>
	Hot-dip galvanized (ASTM A153 – Class C)
	Type 410 stainless steel with protective top coat
High	Type 303 or 304 stainless steel
Severe	Type 316 stainless steel

1. Mechanically galvanized Titen HD® anchors are recommended only for temporary outdoor service.

## Corrosion Resistance Classifications

Environment	Material to Be Fastened						Fire-Retardant-Treated Wood
	Untreated Wood or Other Material	Preservative-Treated Wood				Other or Uncertain	
		SBX-DOT Zinc Borate	Chemical Retention ≤ AWWA, UC4A	Chemical Retention > AWWA, UC4A	ACZA		
Dry Service	Low	Low	Low	High	Medium	High	Medium
Wet Service	Medium	N/A	Medium	High	High	High	High
Elevated Service	High	N/A	Severe	Severe	High	Severe	N/A
Uncertain	High	High	High	Severe	High	Severe	Severe
Ocean/Waterfront	Severe	N/A	Severe	Severe	Severe	Severe	N/A

1. These are general guidelines that may not consider all application criteria. Refer to product-specific information for additional guidance.
2. Type 316/305/304 stainless-steel products are recommended where preservative-treated wood used in ground contact has chemical retention level greater than those for AWWA UC4A; CA-C, 0.15 pcf; CA-B, 0.21 pcf; micronized CA-C, 0.14 pcf; micronized CA-B, 0.15 pcf; ACQ-Type D (or C), 0.40 pcf.
3. Testing by Simpson Strong-Tie following ICC-ES AC257 showed that mechanical galvanization (ASTM B695, Class 55), Quik Guard coating, and Double Barrier coating will provide corrosion resistance equivalent to hot-dip galvanization (ASTM A153, Class D) in contact with chemically-treated wood in dry service and wet service exposures (AWPA UC1 – UC4A, ICC-ES AC257 Exposure Conditions 1 and 3) and will perform adequately subject to regular maintenance and periodic inspection.
4. Mechanical galvanizations C3 and N2000 should not be used in conditions that would be more corrosive than AWWA UC3A (exterior, above ground, rapid water run off).
5. If uncertain about Use Category, treatment chemical, or environment, use Types 316/305/304 stainless steel, silicon bronze or copper fasteners.
6. Some treated wood may have excess surface chemicals making it potentially more corrosive than lower retentions. If this condition is suspected, use Types 316/305/304 stainless steel, silicon bronze or copper fasteners.
7. Types 316/305/304 stainless steel, silicon bronze or copper fasteners are the best recommendation for ocean salt-air and other chloride-containing environments. Hot-dip galvanized fasteners with at least ASTM A153, Class C protection can also be an alternate for some applications in environments with ocean air and/or elevated wood moisture content.

## Supplemental Topics for Anchors

### V. Mechanical Anchors

#### Pre-Load Relaxation

Expansion anchors that have been set to the required installation torque in concrete will experience a reduction in pre-tension (due to torque) within several hours. This is known as pre-load relaxation. The high compression stresses placed on the concrete cause it to deform which results in a relaxation of the pre-tension force in the anchor. Tension in this context refers to the internal stresses induced in the anchor as a result of applied torque and does not refer to anchor capacity. Historical data shows it is normal for the initial tension values to decrease by as much as 40–60% within the first few hours after installation. Retorquing the anchor to the initial installation torque is not recommended or necessary.

#### Anchors Adjacent to Abandoned Holes

Testing was performed on various anchor types including drop-in anchors, wedge-type anchors, screw anchors, and adhesive anchors adjacent to holes that have been abandoned. Nominal anchor diameters of  $\frac{3}{4}$  in. and smaller were included as part of this test program. The distance between the installed anchor and the abandoned hole(s) was measured as the center of the anchor to the center of the abandoned hole, as shown as distance “L” in Figure 1. The minimum distance “L” examined in these tests was two times the drilled hole diameter, “d.” Figure 1: Example of Installed Anchor Adjacent to Abandoned Hole Based on the results of this test program, Simpson Strong-Tie® suggests the following guidelines for tension performance of anchors near abandoned holes:

1. Anchors should not be installed closer than 2 times the drilled hole diameter (2d) away from an abandoned hole.
2. Anchors that are more than 2 inches away from abandoned holes do not require a reduction in capacity.
3. Expansion anchors, such as drop-in and wedge-type anchors, that are more than two times the drilled hole diameter (2d), but less than 2 inches from abandoned holes, should have a factor of 0.80 applied to their calculated tension capacity.
4. Concrete screws and adhesive anchors that are more than two times the drilled hole diameter (2d), but less than 2 inches from abandoned holes, should have a factor of 0.90 applied to their calculated tension capacity.
5. Where abandoned holes have been filled with a non-expansive grout or anchoring adhesive and allowed to completely cure, no reduction is necessary for anchors installed more than two times the drilled hole diameter (2d) away from the filled holes.

#### Summary of Capacity Reductions Due to Abandoned Holes

Anchor Type	Abandoned Hole Distance	Capacity Adjustment Factor
All types tested	$L > 2"$	1.0
Expansion anchors	$2d < L \leq 2"$	0.8
Concrete screws and adhesive anchors	$2d < L \leq 2"$	0.9
All types tested, with abandoned holes re-filled as noted on item 5 above	$L \geq 2d$	1.0

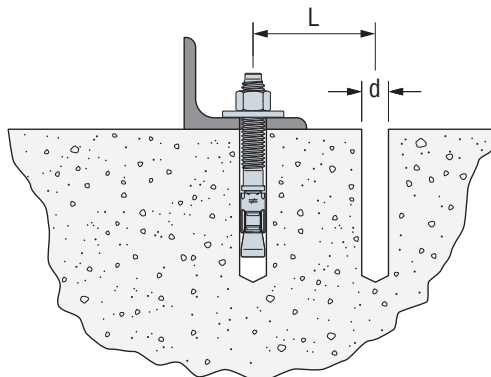

**Figure 1**  
Example of Installed Anchor Adjacent to Abandoned Hole

## Supplemental Topics for Anchors

### VI. Adhesive Anchors

#### Installation into Green Concrete

The strength design data for adhesive anchors in this catalog are based on installations into concrete that is at least 21-days old. For anchors installed into concrete that has cured for less than 21 days, refer to the following modification factors that should be applied to the published adhesive bond strength.

Products	Concrete Age When Installed	Concrete Age When Loaded	Bond Strength Factor
SET-3G SET-XP AT-XP ET-HP	14 days	21 days	1.0
		14 days	0.9
	7 days	21 days	1.0
		7 days	0.7

#### Oversized Holes

The performance data for adhesive anchors are based upon anchor tests in which holes were drilled with carbide-tipped drill bits of the same diameter listed in the product's load table. Additional static tension tests were conducted to qualify anchors installed with SET-3G™, SET-XP® and ET-HP® adhesives for installation in holes with diameters larger than those listed in the load tables. The tables indicate the acceptable range of drilled hole sizes and the corresponding tension-load reduction factor (if any). The same conclusions also apply to the published shear load values. Drilled holes outside of the accepted range shown in the charts are not recommended.

#### SET-3G Adhesive — Acceptable Hole Diameter

Insert Diameter (in.)	Acceptable Hole Diameter Range (in.)	Acceptable Load Reduction Factor
1/2	9/16 – 3/4	1.0
5/8	11/16 – 7/8	1.0
3/4	7/8 – 1	1.0
7/8	1 – 1 1/8	1.0
1	1 1/8 – 1 1/4	1.0
1 1/4	1 3/8 – 1 1/2	1.0

#### SET-XP and ET-HP Adhesives — Acceptable Hole Diameter

Insert Diameter (in.)	Acceptable Hole Diameter Range (in.)	Acceptable Load Reduction Factor
1/2	5/8 – 3/4	1.0
5/8	3/4 – 15/16	1.0
3/4	7/8 – 1 1/8	1.0
7/8	1 – 1 5/16	1.0
1	1 1/8 – 1 1/2	1.0
1 1/4	1 3/8 – 1 7/8	1.0

#### AT-XP Adhesive — Acceptable Hole Diameter

Insert Diameter (in.)	Acceptable Hole Diameter Range (in.)	Acceptable Load Reduction Factor
3/8	7/16 – 1/2	1.0
1/2	9/16 – 5/8	1.0
5/8	11/16 – 3/4	1.0



## Supplemental Topics for Anchors

### Core-Drilled Holes

The performance data for adhesive anchors are based upon anchor tests in which holes were drilled with carbide-tipped drill bits. Additional static tension tests were conducted to qualify anchors installed with SET-3G™, SET-XP® and ET-HP® anchoring adhesives for installation in holes drilled with diamond-core bits. In these tests, the diameter of the diamond-core bit matched the diameter of the carbide-tipped drill bit recommended in the product's load table. SET-3G, SET-XP, and ET-HP anchoring adhesive require a reduction factor of 0.7 is applied to the characteristic bond strength ( $\tau_k$ ). The same conclusions also apply to the published allowable shear loads. Tests conducted in core-drilled holes are for non-IBC jurisdictions.

### Installation in Damp, Wet and Submerged Environments

#### SET-3G, SET-XP, ET-HP and AT-XP:

The performance data for adhesive anchors using SET-3G, SET-XP, ET-HP and AT-XP adhesives are based upon tests according to ICC-ES AC308. This criteria requires adhesive anchors that are to be installed in outdoor environments to be tested in water-saturated concrete holes that have been cleaned with less than the amount of hole cleaning recommended by the manufacturer. A product's sensitivity to this installation condition is considered in determining the product's "Anchor Category" (strength reduction factor).

**SET-XP, ET-HP and AT-XP may be installed in dry or water-saturated concrete.**

**SET-3G may be installed in dry, water-saturated or water-filled holes in concrete.**

**Reliability Testing per ICC-ES AC308 is defined as:**

- Dry Concrete — Cured concrete whose moisture content is in equilibrium with surrounding non-precipitate atmospheric conditions.
- Water-Saturated Concrete — Concrete that has been exposed to water over a sufficient length of time to have the maximum possible amount of absorbed water into concrete pores to a depth equal to the anchor embedment.
- Submerged Concrete — Water-saturated concrete that is fully submerged at the time of hole drilling and anchor installation.
- Water-Filled Hole — Drilled hole in water-saturated concrete that is clean yet contains standing water at the time of installation.

## Supplemental Topics for Anchors

### Use of Vacuum in Lieu of Compressed Air

Based on tension tests conducted by Simpson Strong-Tie at our ISO 17025-accredited laboratory, it has been determined that holes for SET-3G™, SET-XP®, ET-HP® and AT-XP® anchors may alternatively be cleared of concrete dust using a vacuum in place of compressed air. Note that the hose of the vacuum must be capable of reaching the bottom of the hole during vacuuming, similar to the compressed air nozzle. Additionally, the specified time duration for vacuuming must be the same as the time duration specified for compressed air. Lastly, the drilled holes must be brushed as is noted in the applicable evaluation reports. Please see the installation illustrations below for further details.

### Hole Preparation – Horizontal, Vertical and Overhead Applications (SET-3G)

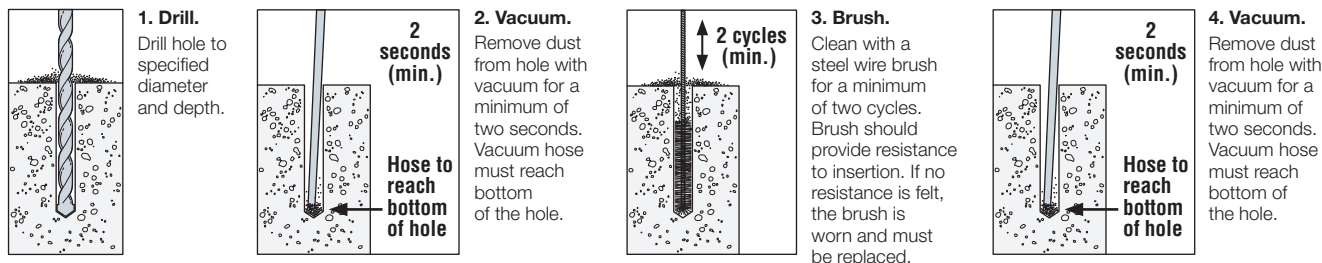

Visit [strongtie.com](http://strongtie.com) for proper brush part number.

### Hole Preparation – Horizontal, Vertical and Overhead Applications (SET-XP, ET-HP and AT-XP)

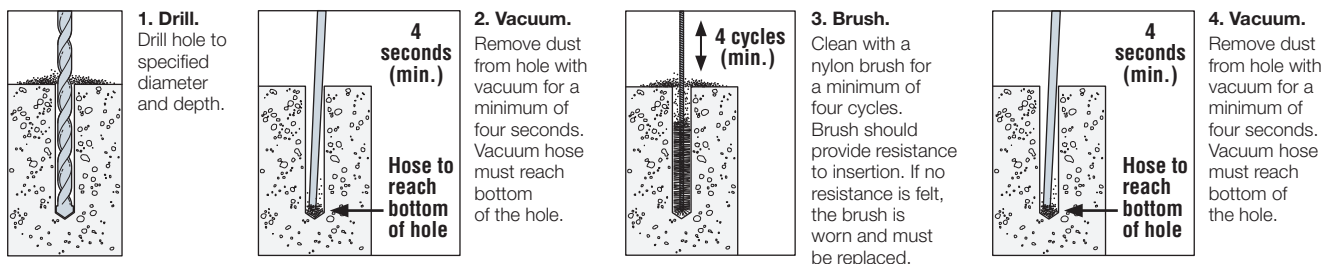

Visit [strongtie.com](http://strongtie.com) for proper brush part number.

### Elevated In-Service Temperature

The performance of all adhesive anchors is affected by elevated base material temperature. The in-service temperature sensitivity table provided for each adhesive provides the information necessary to apply the appropriate load adjustment factor to either the allowable tension based on bond strength or allowable shear based on concrete edge distance for a given base material temperature. While there is no commonly used method to determine the exact load-adjustment factor, there are a few guidelines to keep in mind when designing an anchor that will be subject to elevated base-material temperature. In any case, the final decision must be made by a qualified design professional using sound engineering judgment:

- When designing an anchor connection to resist wind and/or seismic forces only, the effect of fire (elevated temperature) may be disregarded.
- The base-material temperature represents the average internal temperature and, hence, the temperature along the entire bonded length of the anchor.
- The effects of elevated temperature may be temporary. If the in-service temperature of the base material is elevated such that a load-adjustment factor is applicable but, over time, the temperature is reduced to a temperature below which a load-adjustment factor is applicable, the full allowable load based on bond strength is still applicable. This is applicable provided that the degradation temperature of the anchoring adhesive (500°F for SET-3G, SET-XP and ET-HP, and 450°F for AT-XP) has not been reached.

## Supplemental Topics for Anchors

### AT-XP® High-Strength Acrylic Adhesive Installed at 0°F (-18°C)

The evaluation report for AT-XP (IAPMO UES ER-263) specifies the concrete temperatures that are permitted during anchor installation, along with the corresponding gel times and cure times.

Based on testing conducted by Simpson Strong-Tie, no reduction in load values was observed when anchors were installed into concrete that has a temperature of 0°F (-18°C). The table below highlights the gel time and cure time associated with concrete temperatures that range between 0°F and 14°F (-18°C and -10°C). Installation instructions noted on the AT-XP cartridge label and on p. 64 shall be followed.

#### AT-XP Cure Schedule

Concrete Temperature Range		Gel Time (minutes)	Cure Time (hrs.)
0°F	0°C		
0 to 14	-18 to -10	30	24

It is noted that the temperature of the AT-XP cartridge shall be at least 65°F (+18°C) when used for anchor installations into concrete that is between 0°F and 14°F (-18°C and -10°C).

### Epoxy-Coated Reinforcing Bar Installed with SET-3G™, SET-XP®, AT-XP and ET-HP® Anchoring Adhesives into Cracked and Uncracked Concrete.

*(For Anchorage Design in Accordance with ACI 318-14 Chapter 17 / ACI 318-11 Appendix D)*

The evaluation reports for SET-3G (ICC-ES ESR-4057), SET-XP (ICC-ES ESR-2508), AT-XP (IAPMO UES ER-263) and ET-HP (ICC-ES ESR-3372) present the characteristic bond strength of the adhesives for uncoated reinforcing bar (rebar) installations in concrete. These values are based on testing in accordance with ACI 355.4 and the values are to be used in conjunction with ACI 318 Anchoring to Concrete provisions.

Based on testing conducted by Simpson Strong-Tie at our IAS accredited laboratory (accreditation number TL-284), it has been determined that SET-3G, SET-XP, AT-XP and ET-HP adhesives may be used with epoxy-coated rebar when a factor of 0.85 is applied to the published characteristic bond strength ( $\tau_k$ ) published in the evaluation report for uncoated rebar.

## Supplemental Topics for Anchors

## Chemical Resistance of Adhesive Anchors

- Samples of Simpson Strong-Tie® anchoring adhesives were immersed in the chemicals shown here until they exhibited minimal weight change (indicating saturation) or for a maximum of three months.
- The samples were then tested according to ASTM D543 Standard Practices for Evaluating the Resistance of Plastics to Chemical Changes, Procedures I & II, and either ASTM D790 Standard Test Method for Flexural Properties of Unreinforced and Reinforced Plastics and Electrical Insulating Materials or ASTM D695 Standard Test Method for Compressive Properties of Rigid Plastics.
- In cases where mild chemicals were evaluated, the exposure was accelerated per ASTM D3045 Standard Practice for Heat Aging of Plastics Without Load.
- Samples showing no visible damage and demonstrating statistically equivalent strength and elastic modulus as compared to control samples were classified as **“Resistant” (R)**.
  - These adhesives are considered suitable for continuous exposure to the identified chemical when used as a part of an adhesive anchor assembly.
- Samples exhibiting slight damage, such as swelling or crazing, or not demonstrating both statistically equivalent strength and elastic modulus as compared to control samples were classified a **“Non-Resistant” (NR)**.
  - These adhesives are considered suitable for periodic exposure to the identified chemical if the chemical will be diluted and washed away from the adhesive anchor assembly after exposure, or if only emergency contact with the chemical is expected and subsequent replacement of the anchor would be undertaken.
  - Some manufacturers refer to this as “limited resistance” or “partial resistance” in their literature.
- Samples that were completely destroyed by the chemical, or that demonstrated a significant loss in strength after exposure were classified as **“Failed” (F)**.
  - These adhesives are considered unsuitable for exposure to the identified chemical.

**Note:** In most actual service conditions, the majority of the anchoring adhesive is not exposed to the chemical and thus some period of time is required for the chemical to saturate the entire adhesive. An adhesive anchor would be expected to maintain bond strength and creep resistance until a significant portion of the adhesive is saturated.

Chemical	Concentration	SET-3G	AT-XP	SET-XP	ET-HP
Acetic Acid	Glacial	F	NR	F	F
	5%	F	R	F	F
Acetone	100%	F	F	F	F
Aluminum Ammonium Sulfate (Ammonium Alum)	10%	R	R	R	R
Aluminum Chloride	10%	R	R	R	R
Aluminum Potassium Sulfate (Potassium Alum)	10%	R	R	R	R
Aluminum Sulfate (Alum)	15%	NR	R	R	R
Ammonium Hydroxide (Ammonia)	28%	R	NR	R	NR
	10%	R	R	R	R
	pH = 10	R	R	R	R
Ammonium Nitrate	15%	R	R	R	R
Ammonium Sulfate	15%	R	R	R	R
Automotive Antifreeze	50%	R	R	R	R
Aviation Fuel (JP5)	100%	R	R	R	R
Brake Fluid (DOT3)	100%	R	R	NR	F
Calcium Hydroxide	10%	R	R	R	R
Calcium Hypochlorite (Chlorinated Lime)	15%	R	R	R	R
Calcium Oxide (Lime)	5%	R	R	R	R
Carbolic Acid	10%	F	NR	F	F
	5%	NR	NR	F	F
Carbon Tetrachloride	100%	R	R	R	R
Chromic Acid	40%	R	R	NR	NR
Citric Acid	10%	R	R	R	R
Copper Sulfate	10%	R	R	R	R
Detergent (ASTM D543)	100%	R	R	R	R
Diesel Oil	100%	R	R	R	NR
Ethanol, Aqueous	95%	NR	NR	F	F
	50%	R	NR	NR	NR
Ethanol, Denatured	100%	F	R	F	F
Ethylene Glycol	100%	R	R	R	R
Fluorosilicic Acid	25%	R	R	R	R
Formic Acid	Concentrated	F	F	F	F
	10%	F	R	F	F
Gasoline	100%	R	R	R	R
Hydrochloric Acid	Concentrated	F	NR	F	F
	10%	NR	R	NR	F
	pH = 3	R	R	R	R
Hydrogen Peroxide	30%	NR	R	F	F
	3%	R	R	R	R
Iron (II) Chloride (Ferrous Chloride)	15%	R	R	R	R
Iron (III) Chloride (Ferric Chloride)	15%	R	R	R	R
Iron (III) Sulfate (Ferric Sulfate)	10%	NR	R	R	F
Isopropanol	100%	R	R	F	F
Lactic Acid	85%	F	R	F	F
	10%	NR	R	F	F
Machine Oil	100%	R	R	R	R
Methanol	100%	F	NR	F	F
Methyl Ethyl Ketone	100%	F	NR	F	F

## Supplemental Topics for Anchors

Chemical	Concentration	SET-3G	AT-XP	SET-XP	ET-HP
Methyl Isobutyl Ketone	100%	NR	NR	NR	NR
Mineral Oil	100%	R	R	R	R
Mineral Spirits	100%	R	R	R	R
Mixture of Amines <sup>1</sup>	100%	F	R	F	F
Mixture of Aromatics <sup>2</sup>	100%	R	NR	NR	R
Motor Oil (5W30)	100%	R	R	R	R
N,N-Diethylaniline	100%	R	R	R	R
Nitric Acid	Concentrated	F	F	F	F
	40%	F	NR	F	F
	10%	NR	R	R	F
	pH = 3	R	R	R	R
Phosphoric Acid	85%	F	R	F	F
	40%	F	R	F	F
	10%	F	R	F	F
	pH = 3	R	R	R	R
Potassium Hydroxide	40%	R	NR	R	NR
	10%	R	NR	R	R
	pH = 13.2	R	R	R	R
Potassium Permanganate	10%	R	R	R	R
Propylene Glycol	100%	R	R	R	NR
Seawater (ASTM D1141)	100%	R	R	R	R
Soap (ASTM D543)	100%	R	R	R	R
Sodium Bicarbonate	10%	R	R	R	R
Sodium Bisulfite	15%	R	R	R	R
Sodium Carbonate	15%	R	R	R	R
Sodium Chloride	15%	R	R	R	R
Sodium Fluoride	10%	R	R	R	R
Sodium Hexafluorosilicate (Sodium Silicon Fluoride)	5%	R	R	R	R
Sodium Hydrosulfide	10%	R	R	R	R
Sodium Hydroxide	60%	R	R	R	R
	40%	R	R	R	R
	10%	R	R	R	R
	pH = 10	R	R	R	R
Sodium Hypochlorite (Bleach)	25%	R	R	R	R
	10%	R	R	R	R
Sodium Nitrate	15%	R	R	R	R
Sodium Phosphate (Trisodium Phosphate)	10%	R	R	R	R
Sodium Silicate	50%	R	R	R	R
Sulfuric Acid	Concentrated	F	F	F	F
	30%	F	R	NR	F
	3%	NR	R	NR	F
	pH = 3	R	R	R	R
Toluene	100%	R	NR	F	NR
Triethanol Amine	100%	R	R	NR	R
Turpentine	100%	R	R	R	R
Water	100%	R	R	R	R
Xylene	100%	R	NR	NR	R

“R” – Resistant, “NR” – Non-Resistant, “F” – Failed, “–” – Not tested

1. Triethanol amine, n-butylamine, N,N-dimethylamine

2. Toluene, methyl naphthalene, xylene

# Glossary

**ACI** — American Concrete Institute

**ACRYLIC** — Polymer based on resins prepared from a combination of acrylic and methacrylic esters.

**ADHESIVE ANCHOR** — Typically, a threaded rod or rebar that is installed in a predrilled hole in a base material with a two-part chemical compound.

**ADMIXTURE** — A material other than water, aggregate or hydraulic cement used as an ingredient of concrete and added to concrete before or during its mixing to modify its properties.

**AERATED CONCRETE** — Concrete that has been mixed with air-entraining additives to protect against freeze-thaw damage and provide additional workability.

**AGGREGATE** — A granular material, such as sand, gravel, crushed stone and iron blast-furnace slag, used with a cementing medium to form a hydraulic cement concrete or mortar.

**AISC** — American Institute of Steel Construction

**ALLOWABLE LOAD** — The maximum design load that can be applied to an anchor. Allowable loads for mechanical and adhesive anchors are based on applying a factor of safety to the average ultimate load.

**ALLOWABLE STRESS DESIGN (ASD)** — A design method in which an anchor is selected such that service loads do not exceed the anchor's allowable load. The allowable load is the average ultimate load divided by a factor of safety.

**AMINE CURING AGENT** — Reactive ingredient used as a setting agent for epoxy resins to form highly crosslinked polymers.

**ANCHOR CATEGORY** — The classification for an anchor that is established by the performance of the anchor in reliability tests such as sensitivity to reduced installation effort for mechanical anchors or sensitivity to hole cleaning for adhesive anchors.

**ANSI** — American National Standards Institute

**ASTM** — American Society for Testing and Materials

**BASE MATERIAL** — The substrate (concrete, CMU, etc.) into which adhesive or mechanical anchors are to be installed.

**BOND STRENGTH** — The mechanical interlock or chemical bonding capacity of an adhesive to both the insert and the base material.

**BRICK** — A solid masonry unit of clay or shale formed into a rectangular prism while plastic and burned or fired in a kiln that may have cores or cells comprising less than 25% of the cross sectional area.

**CAMA** — Concrete and Masonry Anchor Manufacturer's Association

**CAST-IN-PLACE ANCHOR** — A headed bolt, stud or hooked bolt installed into formwork prior to placing concrete.

**CHARACTERISTIC DESIGN VALUE** — The nominal strength for which there is 90% confidence that there is a 95% probability of the actual strength exceeding the nominal strength.

**CONCRETE** — A mixture of Portland cement or any other hydraulic cement, fine aggregate, coarse aggregate and water, with or without admixtures. Approximate weight is 150 pcf.

**CONCRETE BRICK** — A solid concrete masonry unit (CMU) made from Portland cement, water, and aggregates.

**CONCRETE COMPRESSIVE STRENGTH ( $f'_c$ )** — The specified compressive load carrying capacity of concrete used in design, expressed in pounds per square inch (psi) or megapascals (MPa).

**CONCRETE MASONRY UNIT (CMU)** — A hollow or solid masonry unit made from cementitious materials, water and aggregates.

**CORE DRILL** — A method of drilling a smooth wall hole in a base material using a special drill attachment.

**CREEP** — Displacement under a sustained load over time.

**CURE TIME** — The elapsed time required for an adhesive anchor to develop its ultimate carrying capacity.

**DESIGN LOAD** — The calculated maximum load that is to be applied to the anchor for the life of the structure.

**DESIGN STRENGTH** — The nominal strength of an anchor calculated per ACI 318, ICC-ES AC193 or ICC-ES AC308 and then multiplied by a strength reduction factor ( $\phi$ ).

**DROP-IN ANCHOR** — A post-installed mechanical anchor consisting of an internally-threaded steel shell and a tapered expander plug. The bottom end of the steel shell is slotted longitudinally into equal segments. The anchor is installed in a pre-drilled hole using a hammer and a hand-setting tool. The anchor is set when the tapered expander plug is driven toward the bottom end of the anchor such that the shoulder of the hand-setting tool makes contact with the top end of the anchor. A drop-in anchor may also be referred to as a displacement controlled expansion anchor.

**DUCTILITY** — A material under tensile stress with an elongation of at least 14% and an area reduction of at least 30% prior to rupture.

**DUCTILE ANCHOR SYSTEM** — The behavior of an anchor system where a ductile steel insert governs the design over concrete breakout, pullout and adhesive bond.

**DYNAMIC LOAD** — A load whose magnitude varies with time.

## EDGE DISTANCE:

**EDGE DISTANCE (C)** — The measure between the anchor centerline and the free edge of the concrete or masonry member.

**CRITICAL EDGE DISTANCE ( $C_{cr}$  or  $C_{ac}$ )** — The least edge distance at which the allowable load capacity of an anchor is applicable without reductions.

**MINIMUM EDGE DISTANCE ( $C_{min}$ )** — The least edge distance at which the anchors are tested for recognition.

**EFFECTIVE EMBEDMENT DEPTH** — The dimension measured from the concrete surface to the deepest point at which the anchor tension load is transferred to the concrete.

**EMBEDMENT DEPTH** — The distance from the top surface of the base material to the installed end of the anchor. In the case of a post-installed mechanical anchor, the embedment depth is measured prior to application of the installation torque.

**EPOXY RESIN** — A viscous liquid containing epoxide groups that can be crosslinked into final form by means of a chemical reaction with a variety of setting agents.

# Glossary

**EXPANSION ANCHOR** — A mechanical fastener placed in hardened concrete or assembled masonry, designed to expand in a self-drilled or predrilled hole of a specified size and engage the sides of the hole in one or more locations to develop shear and/or tension resistance to applied loads without grout, adhesive or drypack.

**FATIGUE LOAD TEST** — A test in which the anchor is subjected to a specified load magnitude for  $2 \times 10^6$  cycles in order to establish the endurance limit of the anchor.

**GEL TIME** — The elapsed time at which an adhesive begins to increase in viscosity and becomes resistant to flow.

**GROUT** — A mixture of cementitious material and aggregate to which sufficient water is added to produce pouring consistency without segregation of the constituents.

**GROUTED MASONRY (or GROUT-FILLED MASONRY)** — Hollow-unit masonry in which the cells are filled solidly with grout. Also, double or triple-wythe wall construction in which the cavity(s) or collar joint(s) is filled solidly with grout.

**HOT-DIP GALVANIZED** — A part coated with a relatively thick layer of zinc by means of dipping the part in molten zinc.

**IAPMO UES** — IAPMO Uniform Evaluation Service. An ISO 17065 ANSI-accredited company that issues evaluation reports expressing a professional opinion as to a product's building code compliance.

**IBC** — International Building Code.

**ICC-ES** — ICC Evaluation Service. An ISO 17065 ANSI-accredited company that issues evaluation reports expressing a professional opinion as to a product's building code compliance.

**LEGACY ACCEPTANCE CRITERIA** — A past version of an ICC-ES anchor qualification criteria. These are no longer current standards, but are the basis for legacy allowable load data for anchors in concrete. These standards have been replaced by modern standards such as ICC-ES AC193 and AC308.

**LIGHTWEIGHT CONCRETE** — Concrete containing lightweight aggregate. The unit weight of lightweight concrete is not to exceed 115 pcf.

**MASONRY** — Brick, structural clay tile, stone, concrete masonry units or a combination thereof bonded together with mortar.

**MECHANICALLY GALVANIZED** — A part coated with a layer of zinc by means of mechanical impact. The thickest levels of mechanical galvanizing (ASTM B695, Class 55 or greater) are considered to be alternatives to hot-dip galvanizing and provide a medium level of corrosion resistance.

**MORTAR** — A mixture of cementitious materials, fine aggregate and water used to bond masonry units together.

**NOMINAL STRENGTH** — The strength of an element as calculated per ACI 318, ICC-ES AC193 or ICC-ES AC308.

**NORMAL WEIGHT CONCRETE** — Concrete containing normal weight aggregate. The unit weight of normal weight concrete is approximately 150 pcf.

**OBLIQUE LOAD** — A load that is applied to an anchor, which can be resolved into tension and shear components.

**PLAIN CONCRETE** — Structural concrete with no reinforcement or with less reinforcement than the minimum specified for reinforced concrete.

**PORTLAND CEMENT** — Hydraulic cement consisting of finely pulverized compounds of silica, lime and alumina.

**POST-INSTALLED ANCHOR** — Either a mechanical or adhesive anchor installed in a pre-drilled hole in the base material.

**POST-TENSION** — A method of prestressing in which tendons are tensioned after concrete has hardened.

**POT LIFE** — The length of time a mixed adhesive remains workable (flowable) before hardening.

**PRECAST CONCRETE** — A concrete structural element cast elsewhere than its final position in the structure.

**PRESTRESSED CONCRETE** — Structural concrete in which internal stresses have been introduced to reduce potential tensile stresses in concrete resulting from loads.

**PRETENSIONING** — A method of prestressing in which tendons are tensioned before concrete is placed.

**REBAR** — Deformed reinforcing steel which comply with ASTM A615.

**REINFORCED CONCRETE** — Structural concrete reinforced with no less than the minimum amount of prestressed tendons or nonprestressed reinforcement specified in ACI 318.

**REINFORCED MASONRY** — Masonry units and reinforcing steel bonded with mortar and/or grout in such a manner that the components act together in resisting forces.

**REQUIRED STRENGTH** — The factored loads and factored load combinations that must be resisted by an anchor.

**SCREEN TUBE** — Typically a wire or plastic mesh tube used with adhesives for anchoring into hollow base materials to prevent the adhesive from flowing uncontrolled into voids.

**SCREW ANCHOR** — A post-installed anchor that is a threaded mechanical fastener placed in a predrilled hole. The anchor derives its tensile holding strength from the mechanical interlock of the fastener threads with the grooves cut into the concrete during the anchor installation.

**SHEAR LOAD** — A load applied perpendicular to the axis of an anchor.

**SHOTCRETE** — Concrete that is pneumatically projected onto a surface at high velocity. Also known as gunite.

**SLEEVE ANCHOR** — A post-installed mechanical anchor consisting of a steel stud with nut and washer, threaded on the top end and a formed uniform tapered mandrel on the opposite end around which a full length expansion sleeve formed from sheet steel is positioned. The anchor is installed in a predrilled hole and set by tightening the nut by torquing thereby causing the expansion sleeve to expand over the tapered mandrel to engage the base material.

# Glossary

## SPACING:

**SPACING (S)** — The measure between anchors, centerline-to-centerline distance.

**CRITICAL SPACING ( $S_{cr}$ )** — The least anchor spacing distance at which the allowable load capacity of an anchor is applicable such that the anchor is not influenced by neighboring anchors.

**MINIMUM SPACING ( $S_{min}$ )** — The least anchor spacing at which the anchors are tested for recognition.

**STAINLESS STEEL** — A family of iron alloys containing a minimum of 12% chromium. Type-316 stainless steel provides greater corrosion resistance than Types 303 or 304.

**STANDARD DEVIATION** — As it pertains to this catalog, a statistical measure of how widely dispersed the individual test results were from the published average ultimate loads.

**STATIC LOAD** — A load whose magnitude does not vary appreciably over time.

**STRENGTH DESIGN (SD)** — A design method in which an anchor is selected such that the anchor's design strength is equal to or greater than the anchor's required strength.

**STRENGTH REDUCTION FACTOR ( $\phi$ )** — A factor applied to the nominal strength to allow for variations in material strengths and dimensions, inaccuracies in design equations, required ductility and reliability, and the importance of the anchor in the structure.

**TENDON** — In pretensioned applications, the tendon is the prestressing steel. In post-tensioned applications, the tendon is a complete assembly consisting of anchorages, prestressing steel, and sheathing with coating for unbonded applications or ducts with grout for bonded applications.

**TENSION LOAD** — A load applied parallel to the axis of an anchor.

**THIXOTROPIC** — The ability of a fluid to become less viscous (resistant to flow) under shear, then thicken when the shear force is removed.

**TORQUE** — The measure of the force applied to produce rotational motion usually measured in foot-pounds. Torque is determined by multiplying the applied force by the distance from the pivot point to the point where the force is applied.

**ULTIMATE LOAD** — The average value of the maximum loads that were achieved when five or more samples of a given product were installed and statically load tested to failure under similar conditions. The ultimate load is used to derive the allowable load by applying a factor of safety.

**UNDERCUT ANCHOR** — A post-installed anchor that develops its tensile strength from the mechanical interlock provided by undercutting of the concrete at the embedded end of the anchor.

**UNREINFORCED MASONRY (URM)** — A form of clay brick masonry bearing wall construction consisting of multiple wythes periodically interconnected with header courses. In addition, this type of wall construction contains less than the minimum amounts of reinforcement as defined for reinforced masonry walls.

**WEDGE ANCHOR** — A post-installed mechanical anchor consisting of a steel stud with nut and washer, threaded on the top end and a formed uniform tapered mandrel on the opposite end around which an expansion clip formed from sheet steel is positioned. The anchor is installed in a predrilled hole and set by tightening the nut by torquing, thereby causing the expansion clip to expand over the tapered mandrel to engage the base material. A wedge anchor may also be referred to as a torque controlled expansion anchor.

**WYTHE** — A continuous vertical section of masonry one unit in thickness.

**ZINC PLATED** — A part coated with a relatively thin layer of zinc by means of electroplating.



# Alphabetical Index of Products

3GWSP	Opti-Mesh Adhesive Screen Tube	71–72
ARC	Adhesive Retaining Caps	70
AT-XP®	Acrylic Adhesive	54–63
ATR	All Thread Rod	75
ATS	Steel Adhesive-Anchoring Screen Tube	73
AWSP	Opti-Mesh Acrylic Adhesive Screen Tube	71–72
CD	Crimp Drive® Anchor	175–178
CIP-F	Crack Injection Paste Over	222
CI	Crack Injection Epoxy	208–222
CIP-LO	Low Odor Crack Injection Paste Over	222
CPFH	Crack-Pac® Flex-H20™ Crack Sealer	220–221
CSD	Countersunk Split Drive	179–180
CSS	Composite Strengthening Systems™	200–203
DIA	Drop-In Anchor	165–169
DIAB	Drop-In Anchor	160–164
DSD	Duplex Head Split Drive	179–180
DXS	Speed Clean™ Dust Extraction Drill Bits for Concrete and Masonry	236
EIF	Injection Fitting	223
EIP	Injection Port	223
EMN	Epoxy Mixing Nozzle	223
ET-HP®	Epoxy Adhesive	44–53
ETB	Hole-Cleaning Nylon Brush — Standard	68
ETBR	Hole-Cleaning Nylon Brush — Rebar	68
ETBS	Hole-Cleaning Wire Brush — Standard	68
ETIPAC	Crack-Pac® Injection Epoxy	218–219
ETR	Paste-Over Epoxy	222
ETS	Steel Adhesive-Anchoring Screen Tube	73
EWSP	Opti-Mesh Epoxy Adhesive Screen Tube	71–72
EZAC	Easy-Set Pin-Drive Expansion Anchor	141
E-Z-Click	Injection System	223
FX-70®	Structural Pile Repair and Protection System	206–207
FX207	Slurry Seal	202
FX505	Water-Based Acrylic Coating	202
GAC	Angle Clip Pin	188, 190, 194
GCC	Conduit Clip Pin	188
GCN-MEP	Gas-Actuated Concrete Nailer	188
GCT	Tie-Strap Holder Pin	188
GDP	Gas Pin	188–189, 192–193, 195–197
GDPS	Stepped-Shank Gas Pin	188, 196–197
GDPSK	Spiral-Knurled Gas Pin	188, 197
GFC	Gas Fuel Cell	188
GTH	Tophat Pin	188–189, 192–193, 195
GTS	Threaded Stud Pin	188
GW	Washer Pin	188–189, 192–193, 195–197
HDIA	Hollow Drop-In Anchor	170–173
HELI	Heli-Tie Helical Wall and Stitching Tie	230–233
P22AC	0.22-Caliber “A” Crimp Loads — Single Shot	187
P25SL	0.25-Caliber Plastic 10-Shot Strip Loads	187

## Alphabetical Index of Products

P27LVL	0.27-Caliber Single-Shot Loads — Long	187
P27SL	0.27-Caliber Plastic 10-Shot Strip Load	187
PBXDP	BX Cable Strap	184, 186
PCC	Conduit Clip	184, 186
PCLDPA	Ceiling Clip	184–185, 190, 194
PDPA	0.157" Shank Diameter Drive Pin	184–185, 189, 192–193, 195–197
PDPAS	0.157" Shank Diameter Drive Pin	184–185
PDPAT	0.157" Shank Diameter Tophat Fastener	184–185, 189, 192–193, 195–197
PDPAWL	0.157" Shank Diameter with 1" Metal Washer	184–185, 189, 191–193, 195–197
PECLDPA	Ceiling Clip	184–185, 190, 194
PHBC	Highway Basket Clip	184, 186
PHD	0.140" Shank Diameter Drive Pin	184, 186
PHT-38	Manual Hammer Tool	186
PINW	100 through 300 – 0.300" Headed Pin with 1 $\frac{7}{16}$ " Washer	184, 186, 189, 192–193, 195–197
PINWP	100 through 300 – 0.300" Headed Pin with 1 $\frac{7}{16}$ " Plastic Washer	184, 186, 189, 192–193, 195–197
PKP	8 mm-Headed Concrete Forming Pin	184, 186
PP	Piston Plug	69–70
PSLV3	$\frac{3}{8}$ "-Headed Fasteners / Threaded Stud	184, 186, 189, 192, 196–197
PT-22A-RB	.22 Cal. Powder-Actuated Tool	184–185
PT-22HA-RB	Hammer-Activated Powder Tool	184–185
PT-27	General Purpose .27 Cal. Powder-Actuated Tool	184–185
PTP-27L	Premium .27 Cal. Powder-Actuated Tool	184–185
PTRHA	0.157" Shank Diameter Threaded Rod Hanger	184, 186, 190, 194
RFB	Retrofit Bolt	74
RND	Rod Hanger Nut Driver	156
RSH	Steel Rod Hanger – Horizontal	156–157
RSV	Steel Rod Hanger – Vertical	156–157
RWH	Wood Rod Hanger – Horizontal	158–159
RWV	Wood Rod Hanger – Vertical	158–159
SET-3G™	High-Strength Epoxy Adhesive	22–28
SET-XP®	High-Strength Epoxy Adhesive	30–43
SL	Sleeve-All® Anchor	136–140
STB2	Strong-Bolt® 2 Wedge Anchor	108–122
STB2 SS	Stainless-Steel Strong-Bolt® 2 Wedge Anchor	108–122
SWN	Sure Wall Anchor – Nylon	181
SWZ	Sure Wall Anchor – Zinc	181
THD	Titen HD® Heavy-Duty Screw Anchor	78–91
THD-CS	Titen HD® Countersunk Heavy-Duty Screw Anchor	79
THD-CS-SS	Stainless-Steel Titen HD® Countersunk Heavy-Duty Screw Anchor	93–94
THD-RC	Titen HD® Rod Coupler	104–106
THD-RH	Titen HD® Threaded Rod Hanger	152–155
THD-SS	Stainless-Steel Titen HD® Heavy-Duty Screw Anchor	92–103
THD-WH	Titen HD® Washer-Head Heavy-Duty Screw Anchor	79
TNT	Titen Turbo™ Concrete and Masonry Screw Anchor	144–149
TTNSS	Titen® Stainless Steel Concrete and Masonry Screw	150–151
TW	Tie-Wire Wedge Anchor	142–143
WA	Wedge-All® Wedge Anchor	123–135
ZN	Zinc Nailon™	174

# Titen Turbo™

## You've got to drive it to believe it.



Reliable installation. Less torque. Superior holding power. Meet the Titen Turbo™, the next-generation concrete and masonry screw anchor from Simpson Strong-Tie. Its revolutionary Torque Reduction Channel traps dust where it can't obstruct the thread action, drastically reducing binding, stripping or snapping.

For a fast, easy and high-strength fastening solution, try our new Titen Turbo screw anchor. Visit [go.strongtie.com/titenturbo](http://go.strongtie.com/titenturbo) or call us at (800) 999-5099 to learn more.

**SIMPSON**  
**Strong-Tie**

®

